

MODERN RADIO
RECEPTION



By
CHARLES R. LEUTZ



MODERN RADIO RECEPTION

BY
CHARLES R. LEUTZ

PUBLISHED BY
EXPERIMENTERS INFORMATION SERVICE, INC.
476 Broadway
New York City
1925

Copyright, 1924
CHARLES R. LEUTZ
Forest Hills, N. Y.

First Edition—November, 1924
Second Edition—February, 1925

NOTE

The facts presented in this book prove conclusively that Charles R. Leutz was solely responsible for the successful introduction of the Super-Heterodyne System to the Broadcast listeners.

His designs have always been far in advance of the copying competitors and new-born "experts" and this book gives full details of the rapid progress made to date, and gives some idea of what to expect in the future.

EXPERIMENTERS INFORMATION SERVICE, INC.,

Publishers.

PREFACE

This is practically the first exposition of the rapidly growing field of Radio Broadcast Reception. A large part of the material is new and heretofore unpublished in any other book. The very lack of authoritative information on receivers is very evident by referring to other books written in recent years. The space devoted to reception is small and relates to systems now obsolete.

The author takes this opportunity to express indebtedness for valuable assistance from the following gentlemen and organizations:

General Radio Co. and Messrs. Eastham and Richmond.

Experimenters Information Service Inc.

General Electric Co.

Western Electric Co.

Mr. C. P. Edwards, Director Canadian Radio Service.

E. T. Cunningham Inc.

Mr. C. L. Farrand.

Mr. Paul F. Godley.

Mr. F. R. Meginniss.

Weston Electrical Instrument Co.

Mr. Alex. Norden.

Mr. J. M. High, Jr.

Mr. Irving Salzer.

Mr. F. W. Diehl.

Golden-Leutz Inc.

Formica Insulation Co.

Jewell Electrical Instrument Co.

Dubilier Condenser and Radio Co.

National Carbon Co.

Burgess Battery Co. and Mr. W. B. Schulte.

Mr. J. R. Booth, Jr., Ottawa, Canada.

Willard Storage Battery Co.

CHARLES R. LEUTZ.

CONTENTS

CHAPTER I.	REGENERATIVE RECEIVERS	7
CHAPTER II.	SUPER-HETERODYNE RECEIVERS	22
CHAPTER III.	ADAPTERS AND ATTACHMENTS	175
CHAPTER IV.	PLIODYNE RECEIVERS.....	195
CHAPTER V.	LABORATORY EQUIPMENT	219
CHAPTER VI.	TRANSMITTING EQUIPMENT	277
CHAPTER VII.	GENERAL DATA	299

CHAPTER I

REGENERATIVE RECEIVERS

The action of Regenerative Amplification, commonly known as Regeneration was first given considerable publicity by Armstrong although several other American and Foreign inventors claim that they are the original discoverers of this phenomena. The patents issued were sold to the Westinghouse Co. by Armstrong and patents licenses were given to the Radio Corporation, General Electric Co. and others.

An ~~advanced~~ three-circuit regenerative receiver is shown in Figures 1 and 2, front and rear views respectively. Regenerative action consists of feeding a signal into a three element vacuum tube, where the signal is amplified, this amplified signal is then fed back into the grid of the same tube and further regenerative amplification takes place.

In designing a complete receiver to accomplish this, certain important factors have to be taken into consideration to obtain maximum regeneration with a high degree of selectivity. Inasmuch as a vacuum detector tube is a potentially operated device, the circuits should be so designed as to deliver maximum voltage to the detector grid. Maximum voltage is obtained by using a small percentage of capacity and a large percentage of inductance in the grid tuning circuit. For example a certain inductance coil in parallel to a .001 MF Variable Condenser will cover a wavelength range of from 200 to 600 meters. If the condenser were four times as large, or the inductance were four times as large, or if both the condenser and inductance were each twice as large, the wavelength range would be doubled, viz. 400 to 1,200 meters. However, to obtain good results in a grid circuit at wavelengths of 200 to 600 meters a .001 MF condenser is too large and a .00025 MF Maximum is much more satisfactory, with the given coil mentioned above, the wavelength range would be one-half as much or 100 to 300 meters, accordingly the inductance must be increased four times to return to the desired wavelength 200 to 600 meters. In actual results the signal is more than four times greater with the larger inductance arrived at above.

It is then apparent that such a circuit would be most efficient at the low end of the condenser scale and the efficiency would fall off for the longer wavelengths as the amount of condenser used is increased, and this is true. To compensate for this, more than one inductance can be used and by switching in a second inductance in series with the first, the low end of the condenser scale can be used for tuning the longer wave-

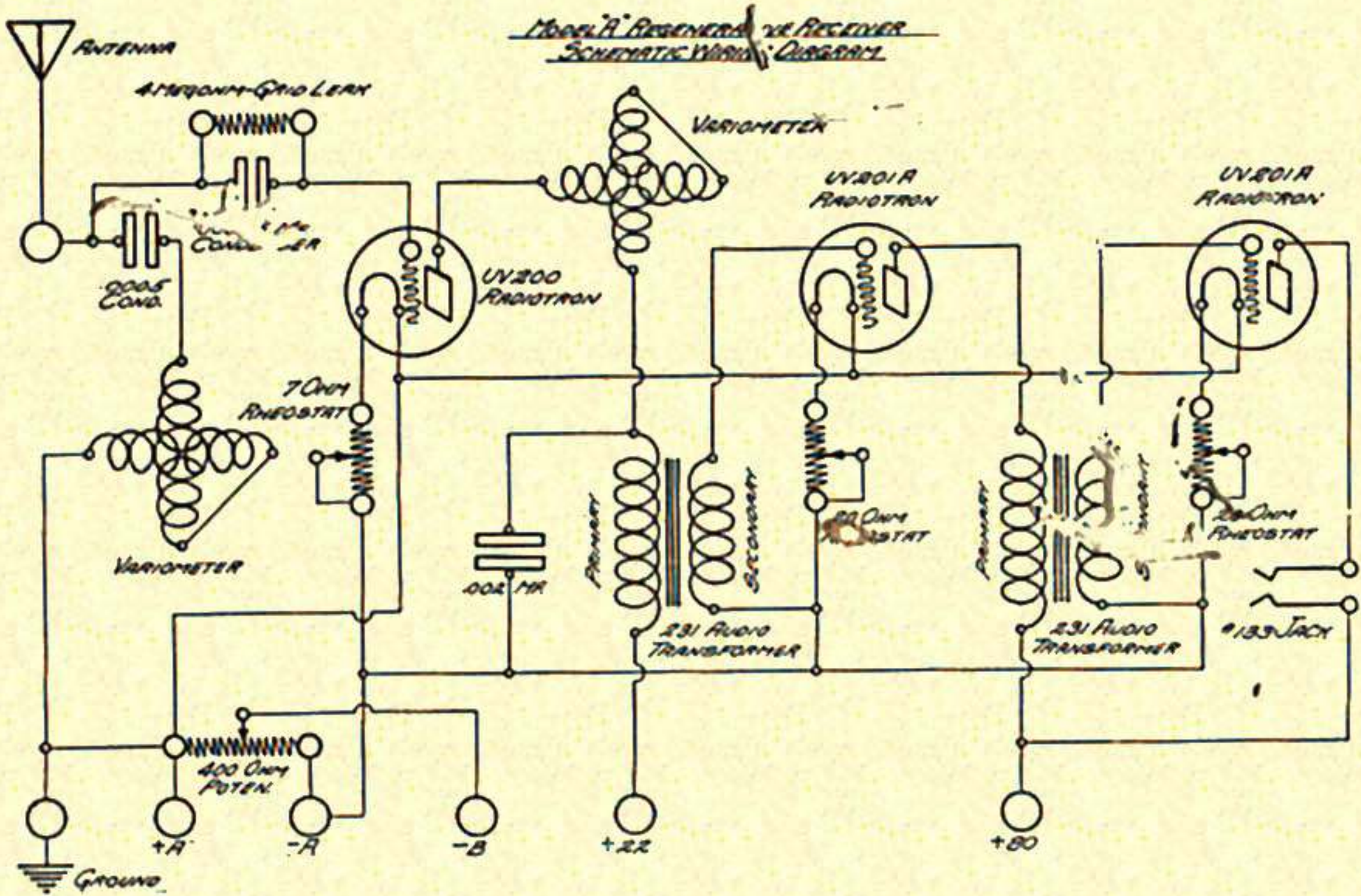

WHEN USING A SHIELDED PANEL,
THE FRAME OF THE JACK MUST
BE INSULATED FROM THE SHIELDING.

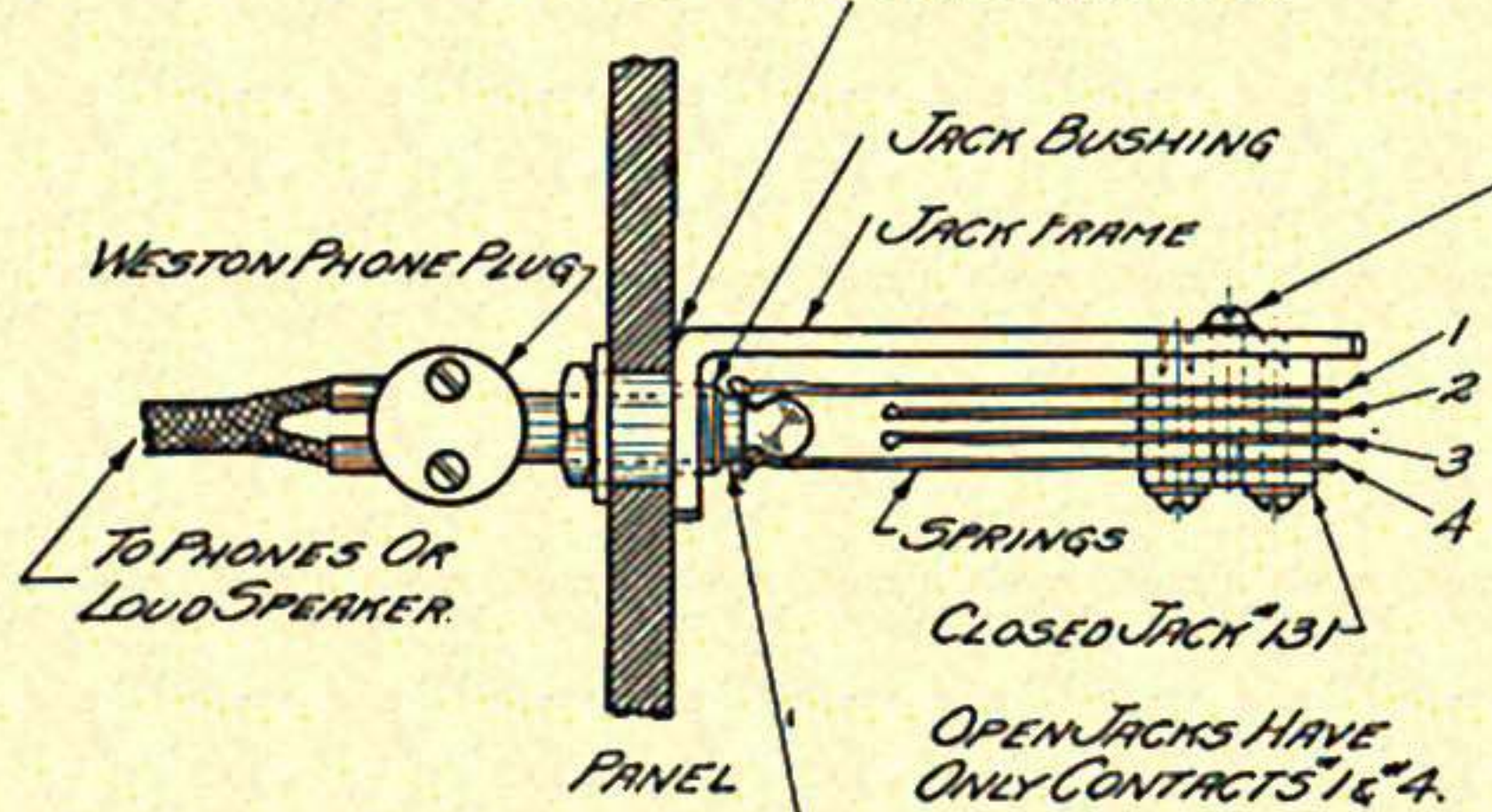

LOOSEN THIS SCREW AND
ADJUST SPRINGS UNTIL
THEY FIT PLUG AS SHOWN,
THEN TIGHTEN UP SCREW.
WHEN THE PLUG IS OUT,
THERE SHOULD BE AN
ELECTRICAL CIRCUIT
BETWEEN SPRINGS #1 & #2
AND ALSO BETWEEN
SPRINGS #3 AND #4.
THERE SHOULD NOT BE
ANY CONTACT BETWEEN
ANY OF THE SPRINGS AND
THE FRAME OF THE JACK.

WHEN THE PLUG IS IN- SPRING #1 SHOULD BE
LIFTED CLEAR OF #2 AND #4 LIFTED CLEAR
OF #3. THE TWO WIRES OF THE PLUG THEN
CONNECT SPRINGS #1 AND #4.

lengths. That is the single inductance would be used for wavelengths of 200 to 400 meters and the two inductances together for 300 to 600 meters.

The next important item is the efficiency of the inductance itself. Every inductance, in addition to being an inductance is a resistance, that

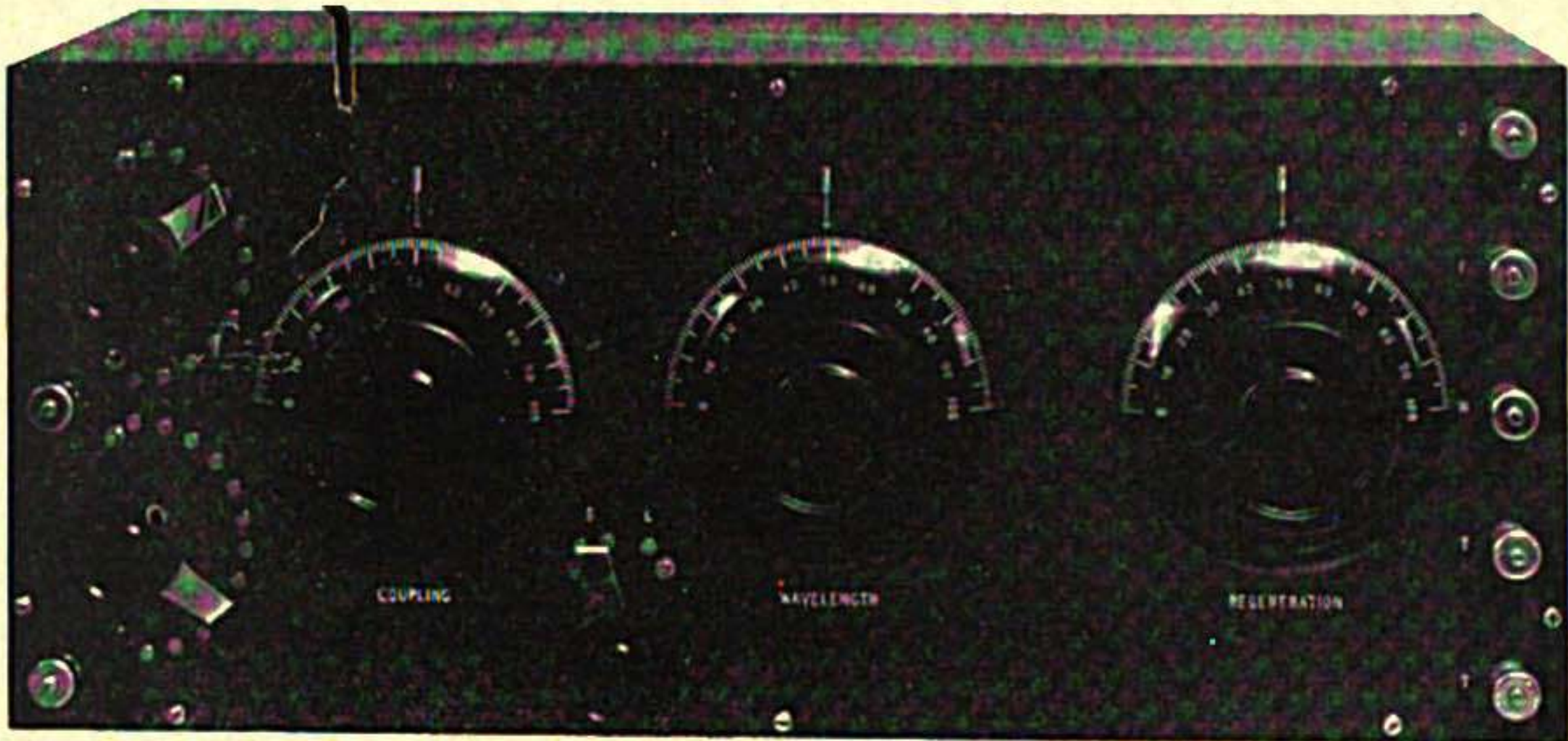
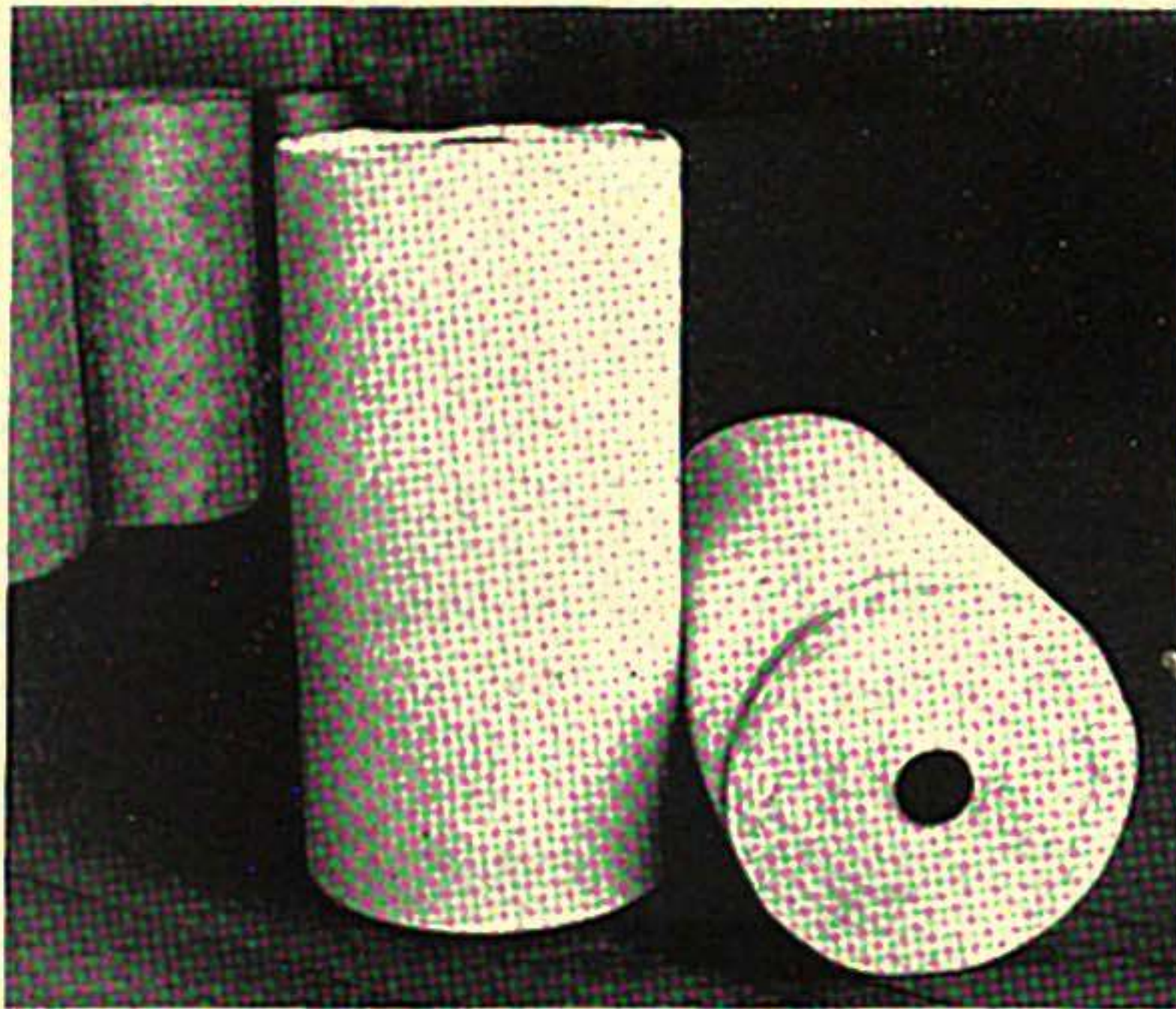

Fig. 1



Fig. 2

is it has a value of high frequency resistance and this value varies with frequency. Two coils each having the same value of inductance may have widely different values of resistance at the same frequency. The poor inductance of high resistance would probably be layer wound on moisture-laden cardboard tubing, covered with shellac or partially con-



Manufacturing Formica.

Rolls of special paper before it goes to the treating machines

ducting varnish. The efficient low resistance coil would most likely be ~~the~~ one wound in a single layer, or bank wound, on an improved insulating material such as Formica, the moisture having been thoroughly baked out in a vacuum and then thoroughly impregnated with a "low capacity" electrical insulating varnish such as "Sterling" or "Ajax." The use of Litzendraht wire will greatly reduce the high frequency resistance of an inductance, particularly at certain frequency ranges. A suitable Litzendraht for all round work consists of 10 number 38 B&S Gauge copper wires, each insulated with enamel, and the entire ten wires grouped in a bunch and insulated with a Silk covering. This wire in this size and other standard sizes is readily obtainable on the market.

The theory of the use of Litzendraht lies in the amount of conducting surface available. High frequency currents travel on the surface. For example a solid copper wire $\frac{1}{4}$ " in diameter would not afford any less surface resistance than a $\frac{1}{4}$ " copper tube only a few thousandths of an inch in wall thickness. In a like manner the ten small wires, each insulated from the other, afford much more conducting surface, a single solid wire having a diameter equal to the ten wires combined.

The value of high frequency resistance increases rapidly with an increase in distributed capacity of an inductance. By distributed capacity, is meant the inherent capacity of the inductance itself. By the use of single layer coils the proper insulating varnish and low loss supporting forms, the distributed capacity can be kept low. The ideal supporting form is air and this can be accomplished by making special self-supporting windings. The next best support among others is Formica Tubing of thin wall thickness. The above mentioned considerations become more important if they are to be used for short wave reception. A coil which may have a resistance of 1 ohm at 10,000 meters may have a resistance of several hundred ohms at 100 meters. Heavy metal casting, magnetic materials and large bodies of moulded insulating material should be excluded from the field of the coils. The shape of a coil is a factor in the maximum amount of inductance obtainable with a given length of wire. For all round purposes the round coil is the best in this respect.

The Variable Condensers used in tuning circuits should be of the highest possible efficiency. The General Radio Co. condensers illustrated throughout this book were the first real low loss condensers offered to the experimental market and have been widely copied with varying degrees of success. Their type 247 condenser has all the stator plates soldered together to prevent points of resistance between plates. The rotor units are soldered in a like manner. The end supporting plates are moulded from a special low loss material. The bearings are

Radiotron UV201A
Static Characteristic
Grid Voltage - Plate Current

Filament volts 5.

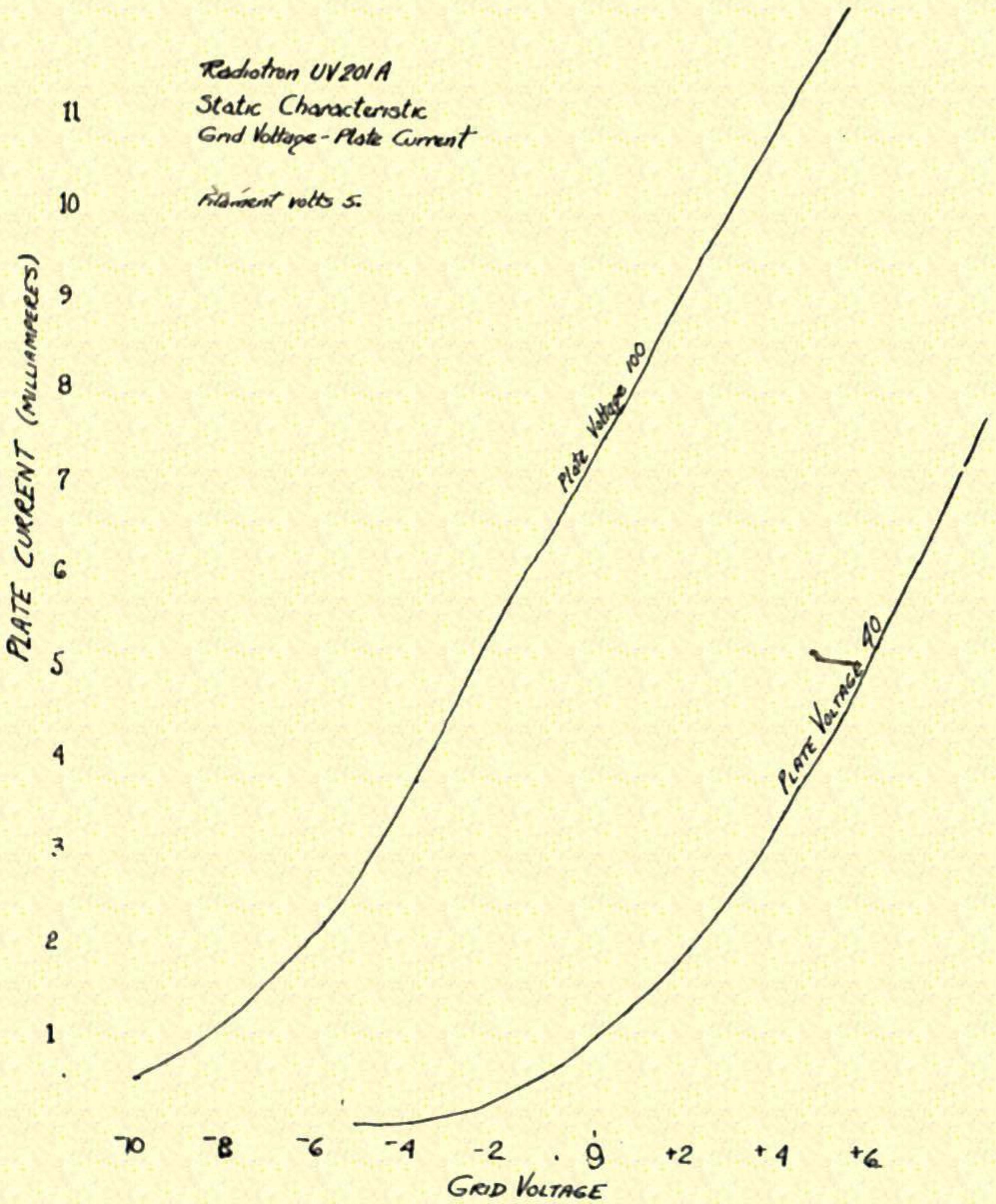

constant friction, noiseless and positive contact. This is undoubtedly the best priced variable condenser on the market. Their type 239 condenser is available where it is desired to obtain still further efficiency at an increased expense. This condenser has metal end plates directly

Condenser

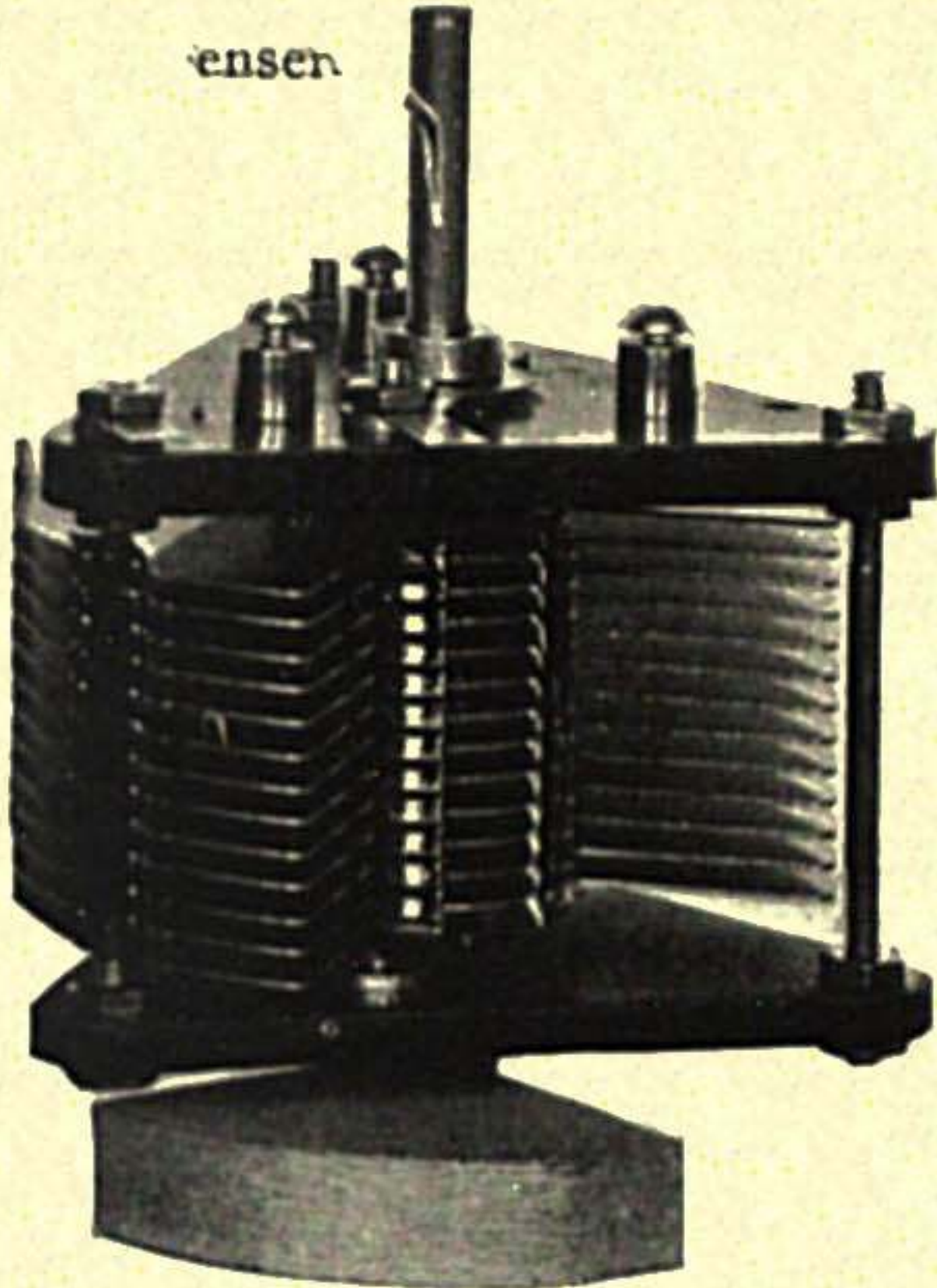

Fig. 3

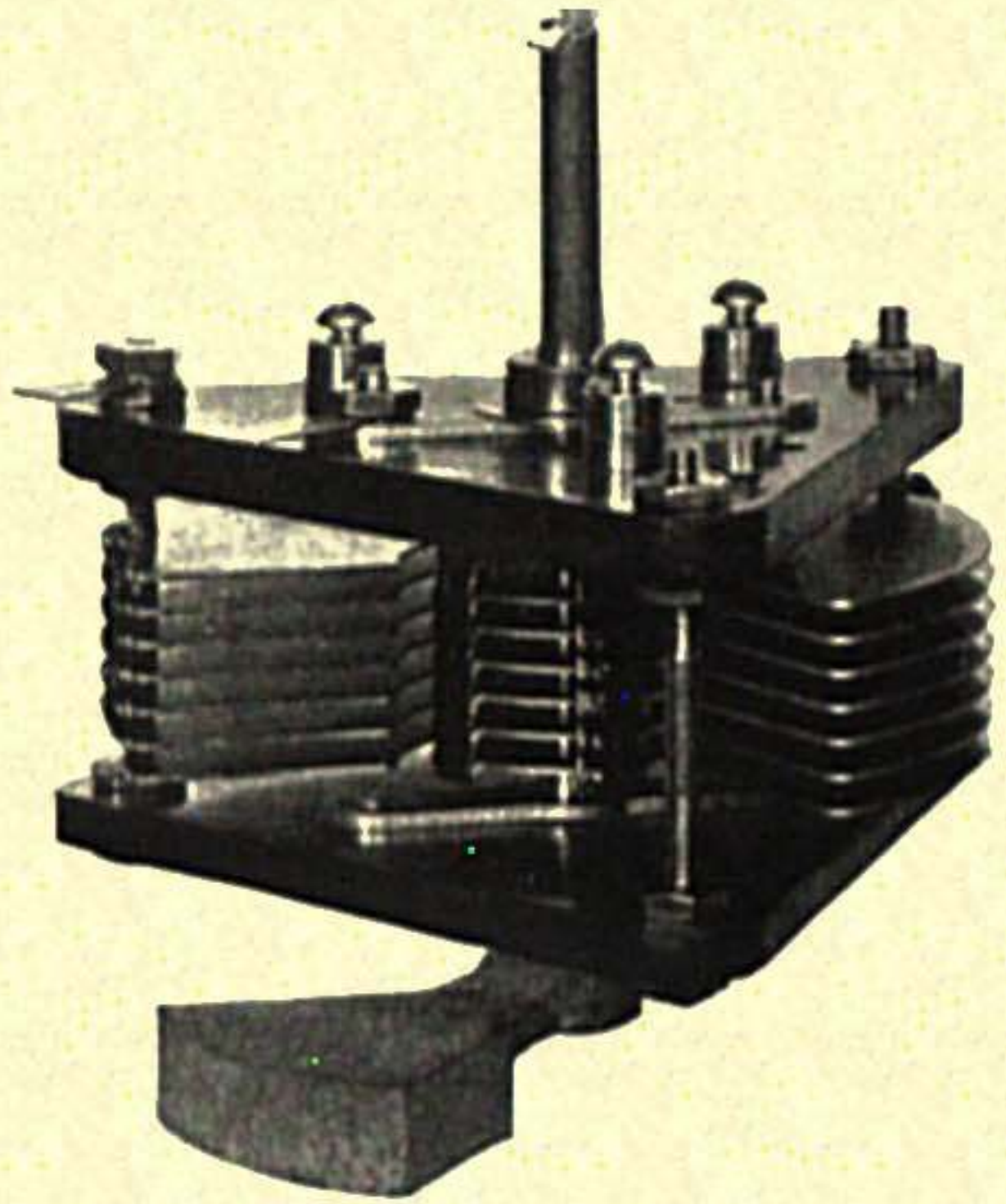

Fig. 4

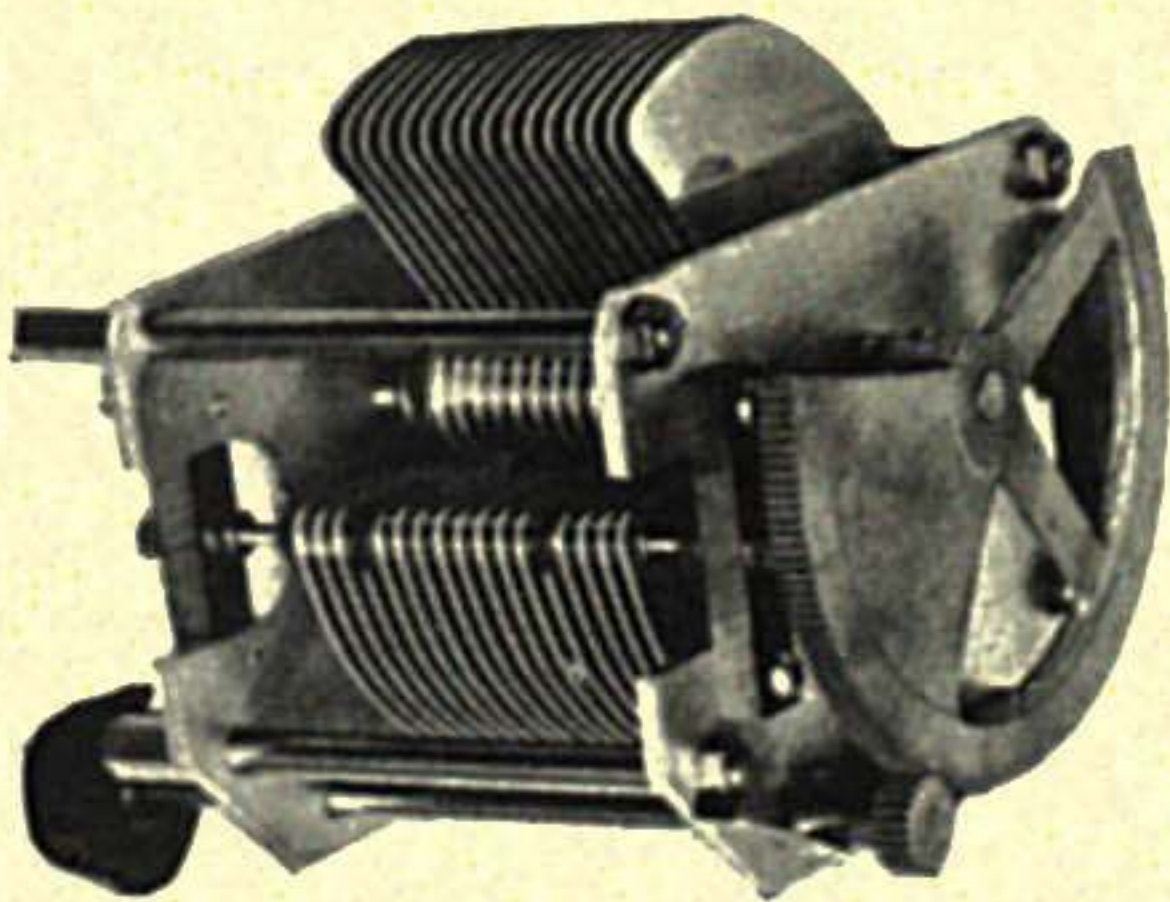

Fig. 5

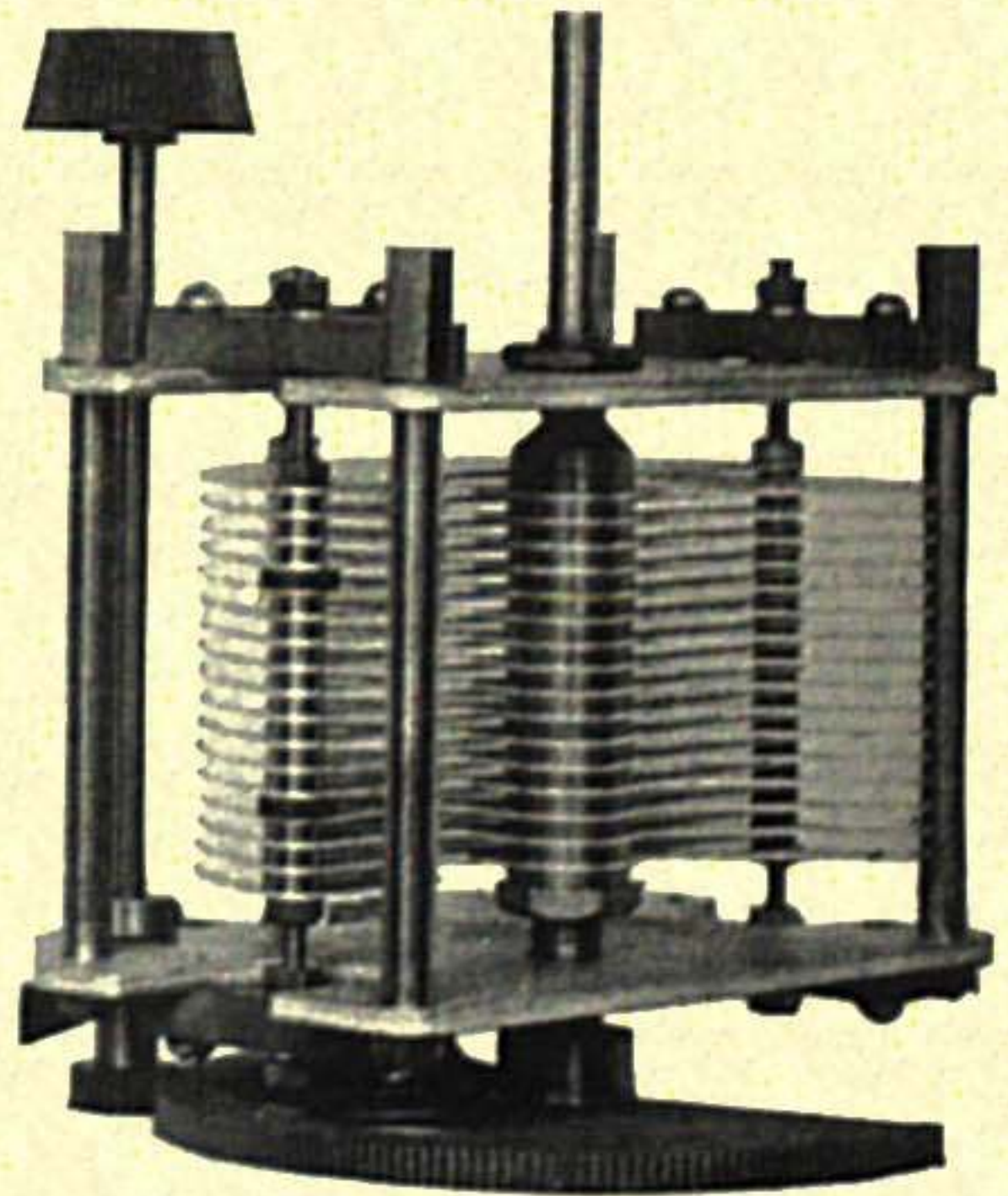
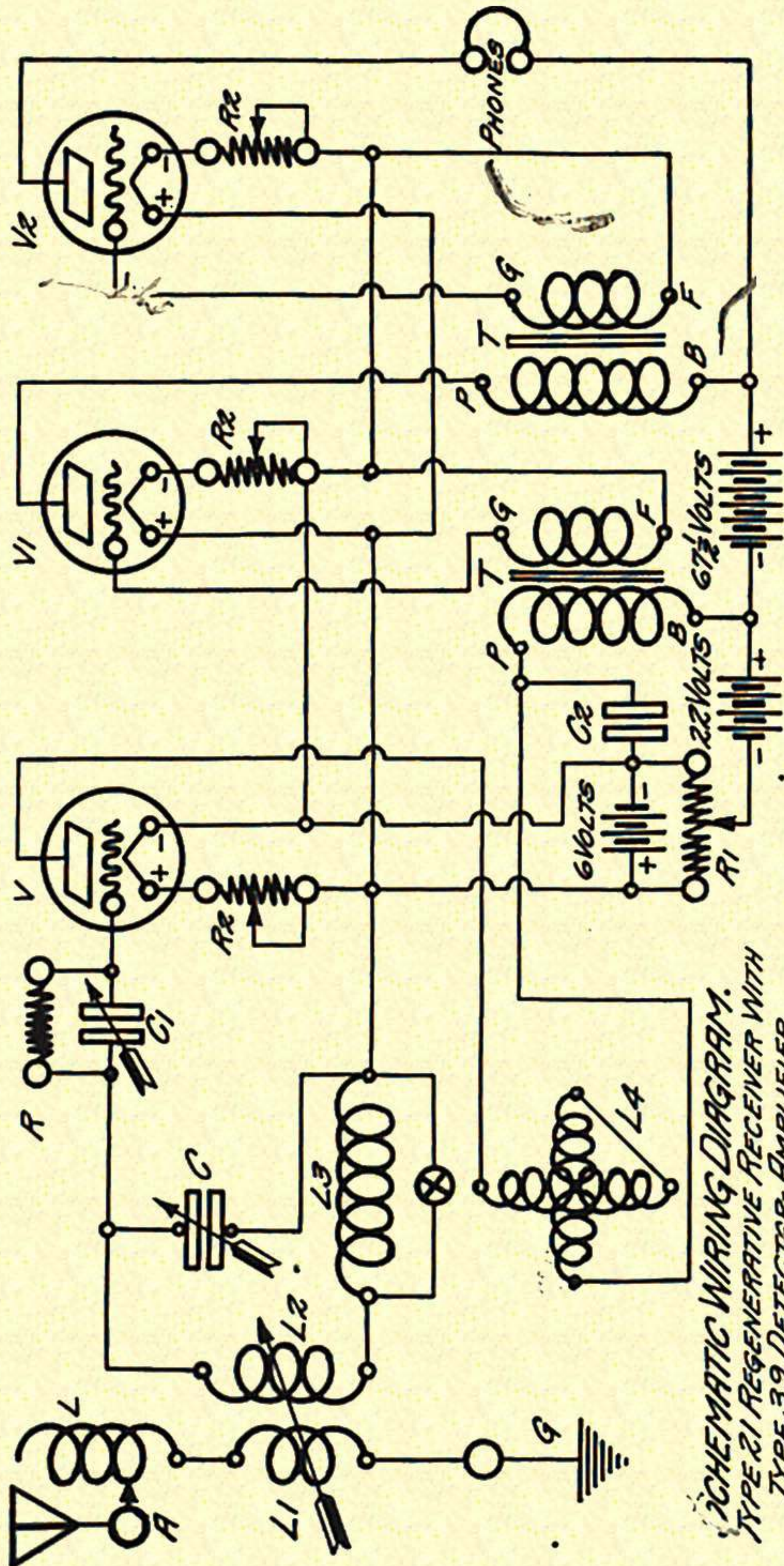

Fig. 6



SCHEMATIC WIRING DIAGRAM.
 TYPE 21 REGENERATIVE RECEIVER WITH
 TYPE 39 DETECTOR-AMPLIFIER.

Fig. 7

connected to the rotor shaft. The stator plates are insulated from the end plates by insulating bars of hard rubber or porcelain which are the best two materials for this purpose. Both the 247 and 239 condensers have special shaped plates which give a straight line wavelength variation with respect to angular movement of the rotor plates.

Condensers with metal end plates, and having the shaft insulated with bushings, are particularly inefficient. Condensers having semi-circular rotor plates are practically obsolete as this form of plate crowds the wavelength range at the lower end of the dial scale. Condensers built with the vernier plates as an integral part are usually inefficient due to the excess of supporting parts. The use of a geared vernier is highly recommended as this does not distract from the efficiency of the condenser in any way. The use of a separate small condenser of approved construction as a vernier is also recommended. Fig. 3 is a type 247 .00025 MF Maximum and Fig. 4 is a .0005 MF Maximum variable condenser. Fig. 5 and 6 show the type 239 Variable Condenser equipped with geared vernier. The excellent design and construction of these instruments are readily apparent.

Referring to the wiring diagram of the Type 21 Receiver shown in Fig. 7. This is the well known Paragon Circuit as designed originally by Mr. Godley and subsequently widely copied by many manufacturers.

L is the primary Load inductance and L1 the primary Coupling inductance. This circuit consisting of the antenna, primary load, primary coupling and ground is tuned to the desired wavelength by varying the inductance in coils L and L1. Coils L1 and L2 are in inductive relation to each other and the relation is also capable of being varied, at 0 degrees on the dial the coils are at right angles to each other and at 100 degrees on the scale, the coils are concentric. The position of this coupler and the amount of inductance in use in the primary and secondary circuit determines the coefficient of coupling between these two circuits.

Coils L2, L3 and Condenser C are used to tune the secondary or grid circuit in resonance to the primary circuit. For example if the Primary circuit was tuned to 312 meters and the secondary circuit was tuned to give maximum response to that same wavelength, it would be said that the secondary circuit was in resonance to the primary circuit. When the secondary is in resonance the maximum amount of signal energy is transferred to the secondary circuit. However when the two circuits are tuned to 312 meters, it may be found that interference is

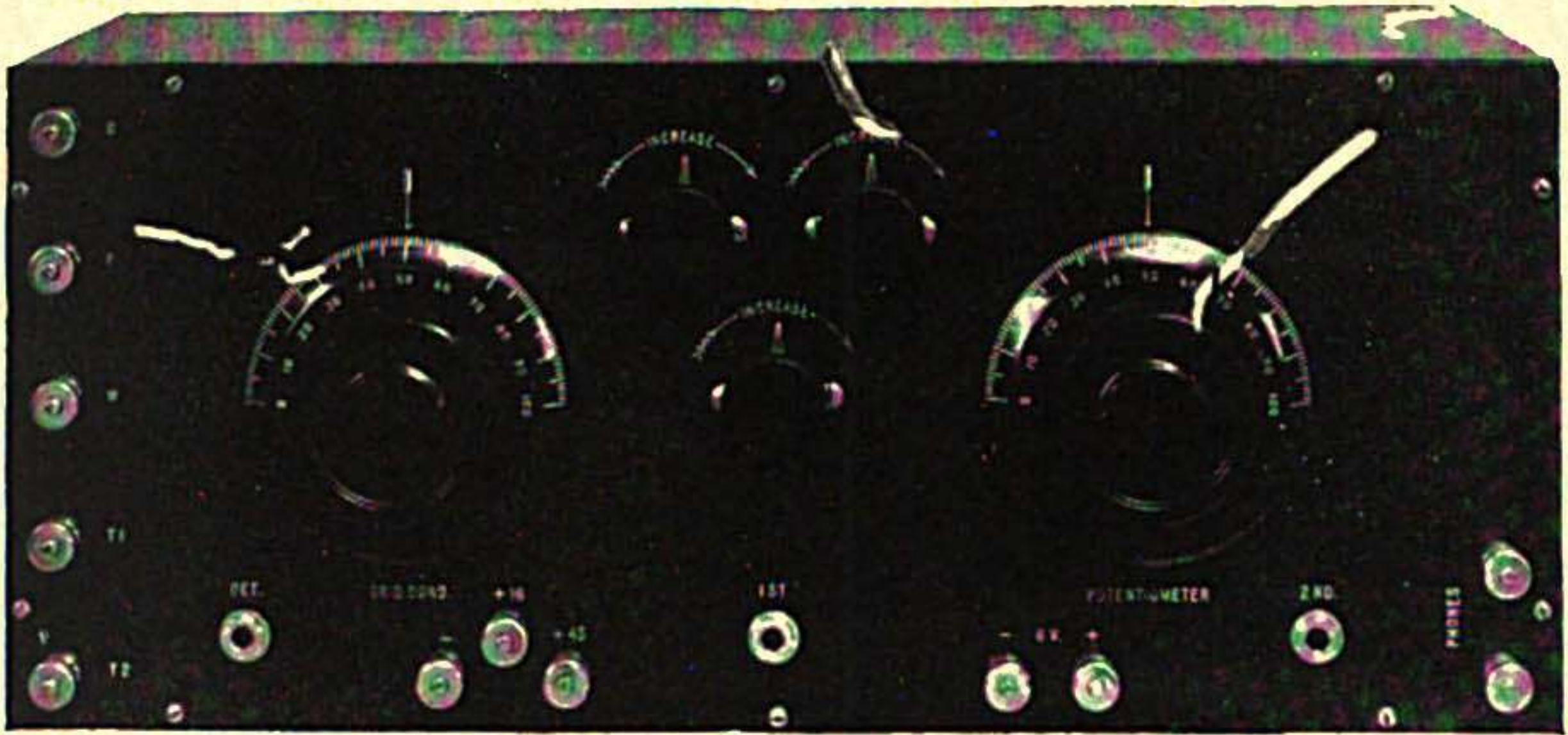

Fig. 8

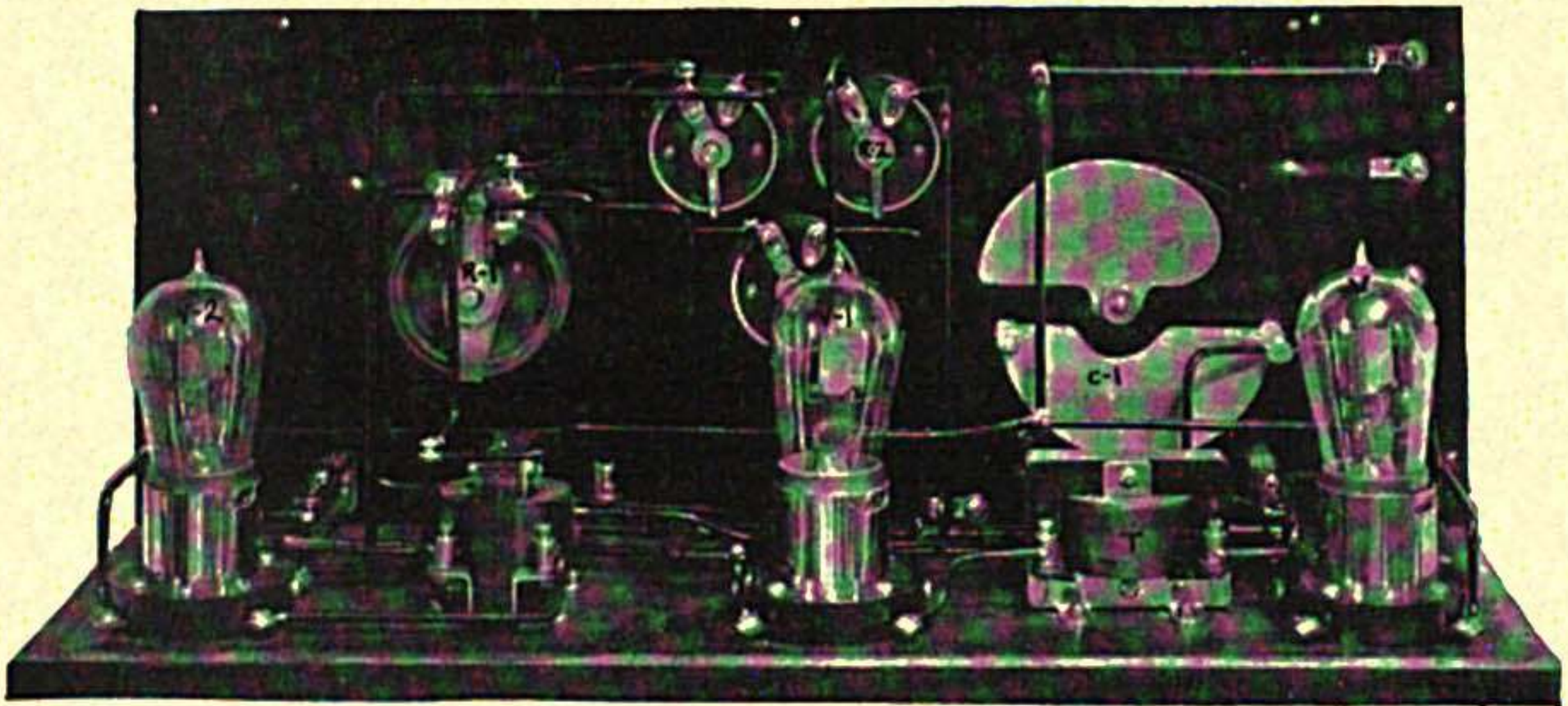

Fig. 9

Front and rear view Type 39 Detector and two-stage Audio Amplifier. The variable Condenser shown may be connected as a variable Grid Condenser or as a vernier on the main tuning condenser.

present from a neighboring wavelength, say 319 meters. To eliminate this interference the coupling is reduced toward 0 degrees on the scale and the primary and secondary circuits retuned. The reduction in coupling reduces the resistance in both of the two circuits and sharper tuning is provided. This reduction in coupling can be carried out to increase selectivity until a point is reached where the reduction in resistance is not greater than the energy transfer loss, and the advantage stops.

After the primary and secondary circuits are tuned to the desired signal, the third circuit, the tertiary circuit can be tuned to the same wavelength to produce regenerative amplification. For the short wavelengths this is accomplished by the use of a Variometer. For the longer wavelengths the third circuit is not tuned to the wavelengths, but grid plate coupling is provided between the Variometer L4 and the secondary load coil L3. When receiving short wavelengths the Load L3 is short circuited and cut out of the secondary circuit. The shaft of the condenser C is connected to the battery side and the stator plates to grid, this prevents all body capacity effect. If the rotor plates were connected to grid there would be very troublesome body capacity effect and it could not be eliminated by shielding. By body capacity effect it is meant that the proximity of the hand to tuning dials changes the tuning, without moving the dials.

When the primary and secondary circuits have been tuned in resonance to the desired signal and the variometer increased to give maximum signal audibility, it will be found that if the secondary circuit is very slightly detuned lower, that the regeneration control can be increased further to advantage.

From the diagram it will be noticed that the negative Detector B Battery return is run to the center arm of a potentiometer. This allows the A Battery potential to be added to the detector battery for a fine adjustment of the detector plate potential. When using a UV201A Detector the difference is not noticeable, but when using a UV200 Gassy detector, this adjustment is extremely critical, as well as the filament temperature adjustment. A small by pass condenser of .001 MF capacity is provided around the first audio transformer primary and detector B Battery to allow unobstructed freedom for the high frequency oscillations. The grid condenser C1 is .00025 MF maximum and the grid leak R should be four megohms for a UV200 detector tube. The grid returns of the secondaries of the audio transformers are connected to the lower side of the rheostats, which provides a negative potential to the grids and lowers the B Battery consumption.

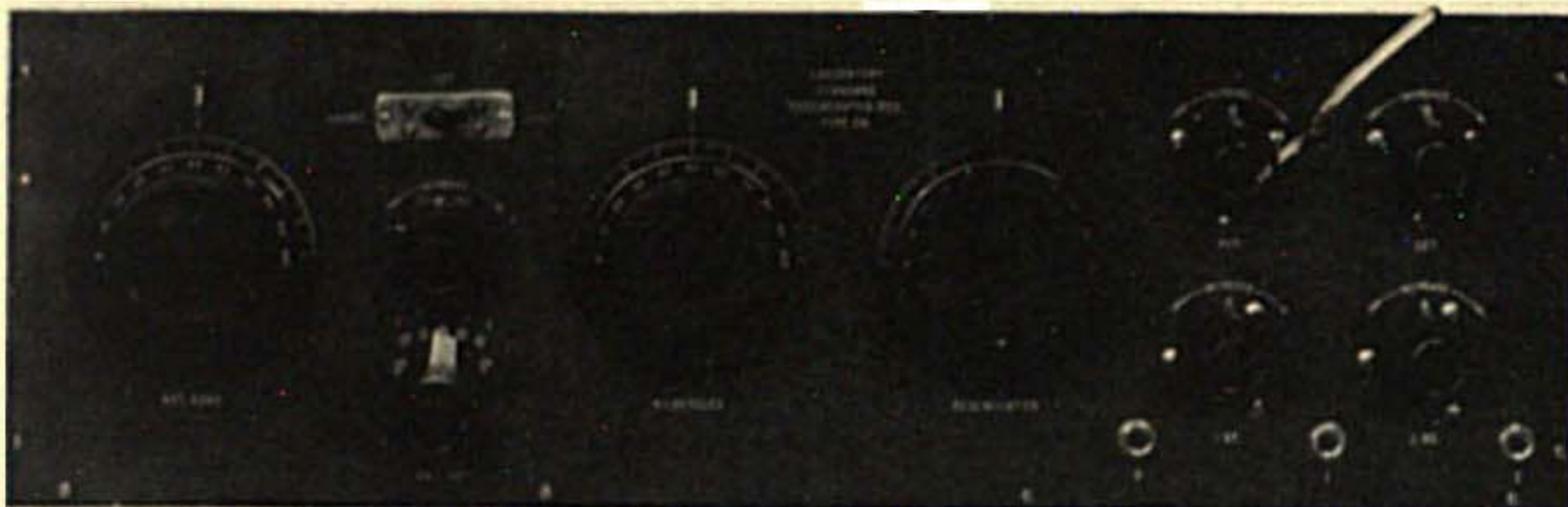

Fig. 10

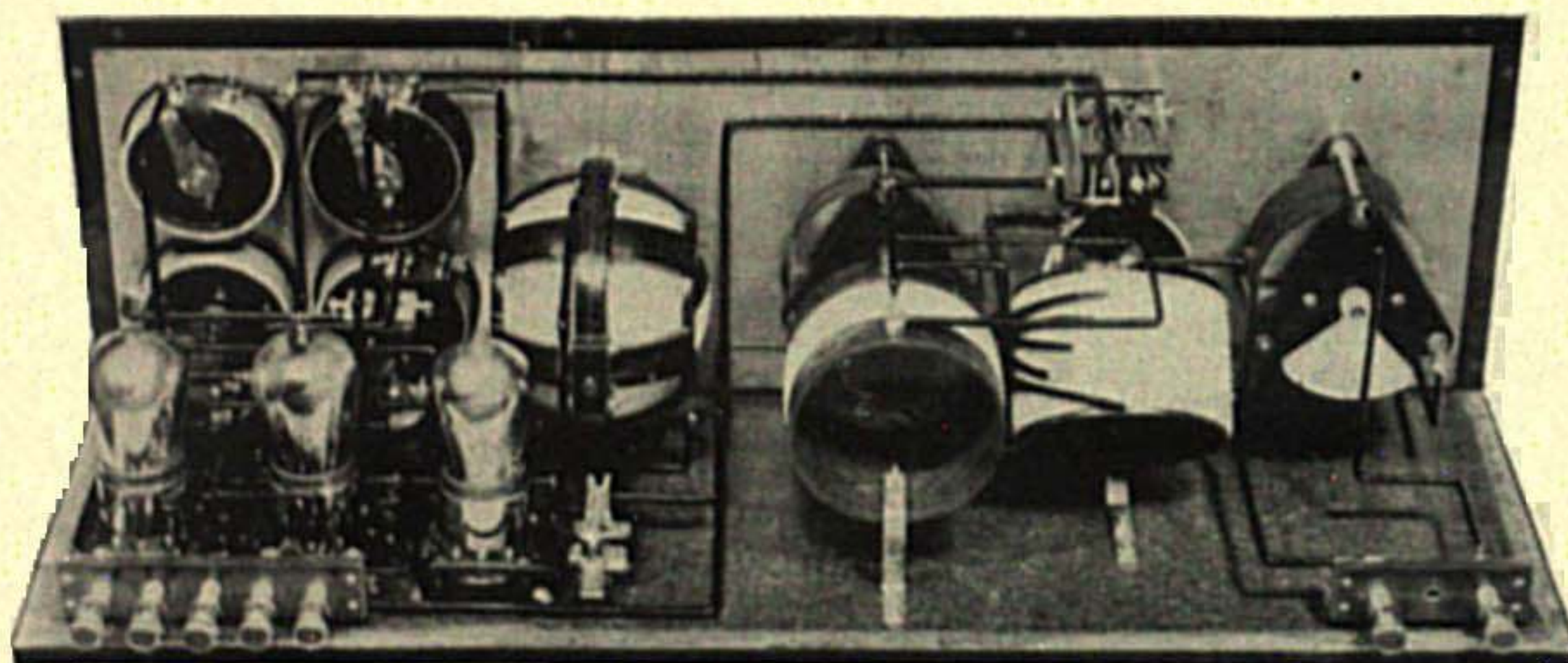

Fig. 11

Front and rear view combined three-circuit regenerative Receiver with Detector and two-stage audio amplifier. All the apparatus is contained in a 25 inch cabinet 8 inches high and seven and three-quarters inches deep. The front panel is shielded with a piece of 12-ounce sheet copper.



Fig. 12

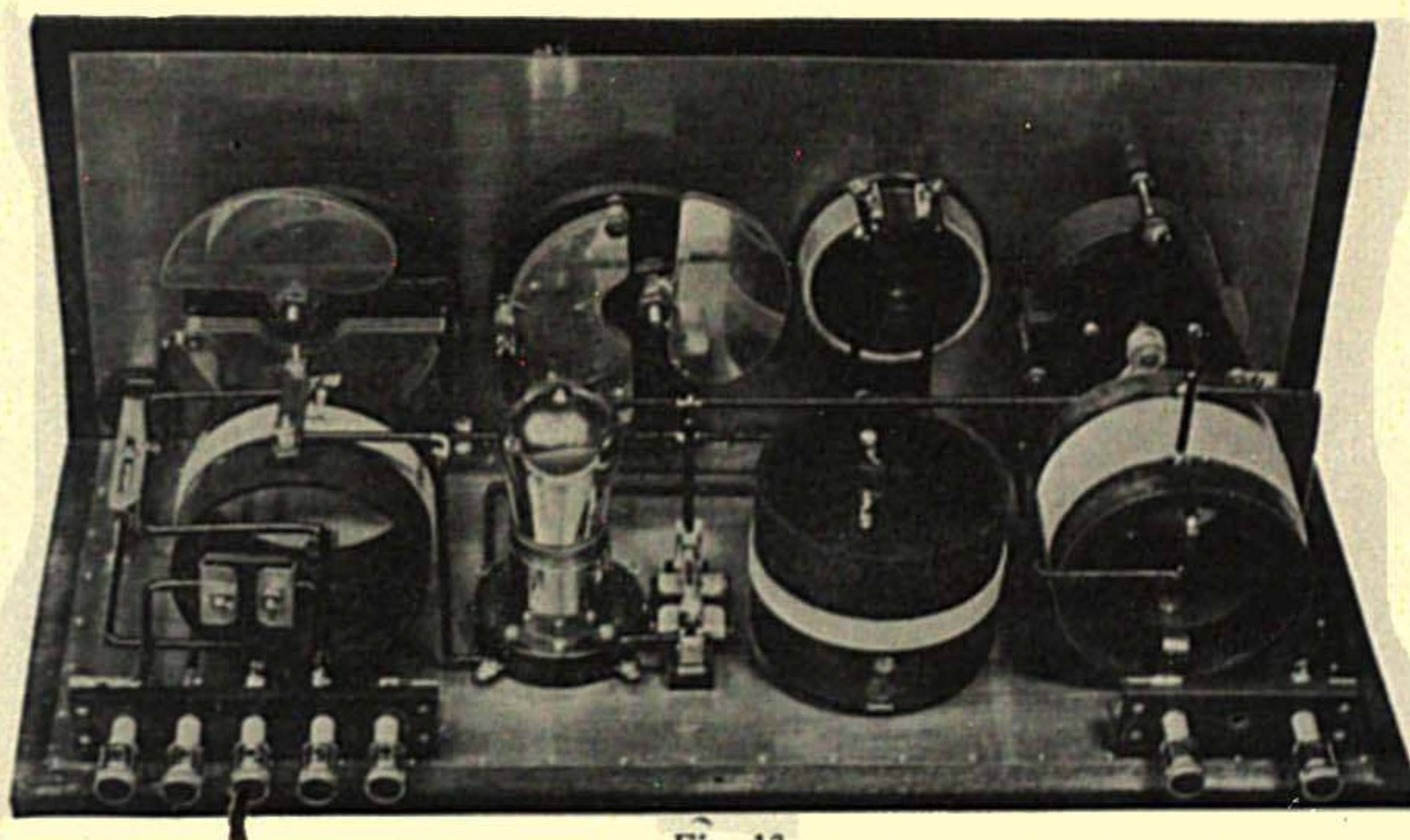
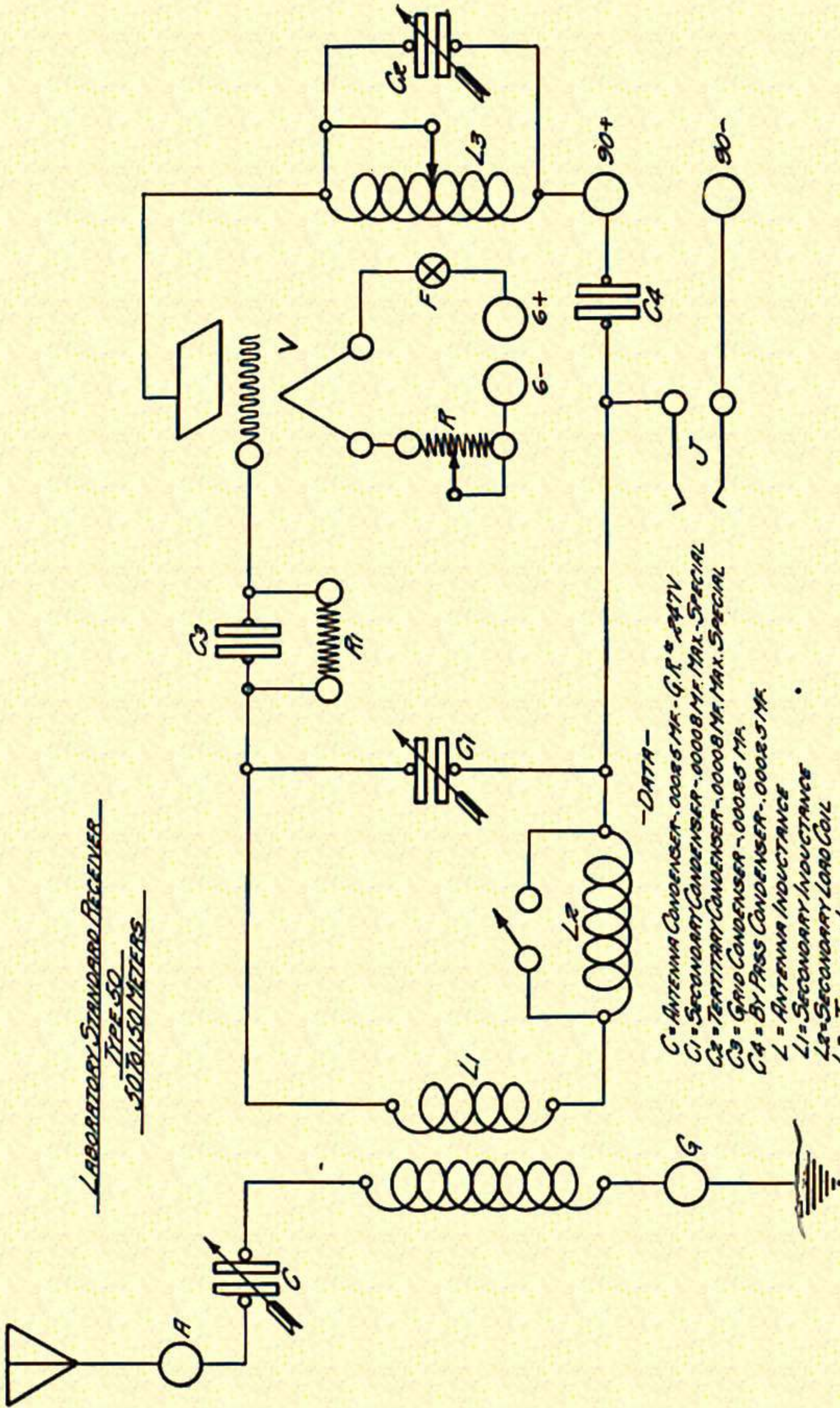

Fig. 13

Front and rear view Type 50 Regenerative Receiver for short wavelengths. In this design the plate variometer is replaced by a fixed inductance with a variable condenser in parallel to obtain the regenerative action. A Detector without audio amplification is included within the cabinet.

LABORATORY STANDARD RECEIVER
TYPE 50
50 TO 150 METERS



- DATA -
- C = ANTENNA CONDENSER - .0008 MF. G. R. # 247V
 - C1 = SECONDARY CONDENSER - .0008 MF. MAX. SPECIAL
 - C2 = TERTIARY CONDENSER - .0008 MF. MAX. SPECIAL
 - C3 = GRID CONDENSER - .00085 MF.
 - C4 = BY PASS CONDENSER - .00085 MF.
 - L = ANTENNA INDUCTANCE
 - L1 = SECONDARY INDUCTANCE
 - L2 = SECONDARY LOAD COIL
 - L3 = TERTIARY INDUCTANCE
 - R = 20 OHM - GEN. RADIO # 214A ARROSTAT
 - R1 = 2 MEGOHM GRID LEAK
 - V = UN201A RADIOVAC AND GEN. RADIO 156 SOCKET
 - F = CUTLER-HAMMER FILAMENT SWITCH.

Fig. 14

Figures 8 and 9 show the front and rear views respectively of the Type 39 Detector and 2 Stage Audio Amplifier.

As the use of a Regenerative Receiver requires skill for maximum results, this type of receiver is being rapidly replaced by receivers that are easier to tune. Furthermore the regenerative receivers if handled improperly oscillate vigorously, causing bad interference with neighboring receivers. The single circuit type of regenerative receiver has so many disadvantages that it is not worth while to describe it.

A Standard Regenerative Receiver having a wavelength range of 160 to 850 meters combined in the same cabinet with the Detector and Two Stage Audio Amplifier is shown in Figs. 10 and 11. The Ant. Condenser and Antenna Inductance Switch tunes the Antenna or Primary Circuit. The Kilocycle Dial controls the Secondary Condenser and this in connection with the Short-Long Switch tunes the Secondary Circuit. The Regeneration Dial controls the Variometer which tunes the Plate of Tertiary Circuit. Rheostats are provided for each of the tubes and a Potentiometer connected to give a fine adjustment to the Detector Plate Voltage. In this design the Antenna Inductance and Antenna Coupling Inductance are wound on the same tube, and a series Variable Antenna Condenser is used to tune the Primary Circuit to resonance.

Figures 12 and 13 cover a Regenerative Receiver with Detector, designed for 50 to 150 meters only. In this receiver the coupling between the Antenna and Secondary circuits is fixed. Internal switches are provided to vary the amount of inductance used. Instead of using a Variometer to tune the Plate Circuit, an inductance with a variable condenser in shunt is substituted as this combination gives a finer adjustment on the regeneration at short wavelengths. As the slightest body capacity makes a decided detuning effect, this receiver is entirely shielded. The schematic wiring diagram is shown in Fig. 14.

It is predicted that within three to five years if not sooner the Regenerative Type of Receiver will be obsolete. This will probably be true even if they are not prohibited by law. A regenerative receiver in the hands of an ordinary layman is in reality a transmitter and interferes seriously with neighboring receivers. In England regenerative or oscillating receivers are prohibited by law and it is possible that similar regulations will be placed in effect in this country in due course. The tuned radio frequency circuits and receivers are much easier to tune and most of them are non-oscillating and this type of receiver is rapidly replacing the ordinary regenerative receivers.

CHAPTER II

SUPER-HETERODYNE RECEIVERS

In the experimental radio field there is a great general desire to receive over long distances. While this is quite possible under certain conditions, it is also impossible under other conditions. Signals from a great distance are weak when picked up by a receiving antenna and it is necessary to amplify these signals at radio frequencies before rectifying and changing to audio currents. It is immediately thought that if the signal is very weak, it is only necessary to use a large number of amplifying units to raise the signal to a readable audibility, and this would be true if there were no static. Fig. 15 illustrates exactly what happens. Accordingly if the signal is weaker than the local static it is useless to try and obtain a readable signal through the use of considerable amplification. The proper way to afford long range reception is to increase the power of the transmitting stations, so that the received energy at a distance will be greater than the static. In the winter when static is at a low ebb, powerful receivers can be used for long wave reception. It seems that static is less prevalent at short wavelengths, 10 to 100 meters than at the longer wavelengths and for this reason it may become advisable to carry on broadcasting transmission on these lower wavelengths. The transmitted energy at these short wavelengths also seems to have greater traveling ability, as the short wave programs from E. Pittsburg and Schenectady are easily copied in Europe with one, two and three tube sets, under favorable conditions. Furthermore allowing 10,000 cycles per transmitting station, there is room for 600 different wavelengths between 25 and 50 meters, while there is only room for about 50 different non-interfering wavelengths between 300 and 600 meters.

These advantages point toward the use of short wavelengths in the near future. To facilitate the reception of short waves, it is suggested that all tuning coils in a receiver be provided with contact prongs and sockets, in this manner the coils can be easily removed and smaller inductances quickly inserted for short wave reception.

One of the best known methods of reception of short wavelengths is the Super Heterodyne system and the use of this system is described in detail in this chapter. It is pointed out that while it is possible to reflex tubes to perform double duty in this system, the disadvantages are greater than the advantages secured and is not recommended. It is

thought that the experimenter desires the best and is willing to provide the extra tube or two to secure the maximum results. All the designs shown here are free from reflexing.

The Super-Heterodyne was not discovered by accident, it was the result of original thought to overcome a very difficult problem; the problem was the possibility of amplifying radio frequency currents at very high frequencies.

Each wavelength has a certain frequency; for example, 10,000 meters is a frequency of 30,000 cycles; 5,000 meters is 60,000 cycles; 2,500 meters is 120,000 cycles and 100 meters is 3,000,000 cycles. It is noted that as the wavelength decreases the frequency increases. When designing apparatus to use at these extremely high frequencies, the ordinary electrical engineering formulae do not hold true. An instrument which may be a condenser at 60 cycles might prove to be a resistance at 3,000,000 cycles.

To enable long distance reception, radio frequency amplification is very essential. An ordinary Detector tube such as a Radiotron UV200, 201A or UV199 requires a fairly strong signal to give good response in the telephones. As a matter of fact, if one signal applied to the detector grid is twice as strong as a second signal, the detecting efficiency will be four times as great on the stronger signal. Looking further, it will be appreciated that very weak signals will not be sufficiently strong to operate the detector tube at all, unless they are amplified to a larger order of magnitude first. The possibilities of amplifying these weak signals at long waves is an easy problem but to secure good amplification at frequencies over 200,000 cycles for more than one stage presents many difficulties.

All ordinary amplifying transformers designed for short wave work are only efficient over a very narrow wavelength band. For example, if the transformer is advertised to function over a range of 200 to 500 meters, it will be found that the amplifying efficiency is highest at one particular wavelength, say 350 meters. Each side of this peak the efficiency drops very rapidly. In order to cover a wavelength range of 160 to 850 meters with such transformers, it would be necessary to have about 10 sets of transformers, each suitable for a narrow band of wavelengths.

Tuned Radio Frequency Amplification can be used to good advantage for short wavelengths. This system consists of a number of air core transformers, the grid circuit of each tuned with a variable condenser, to the wavelength that it is desired to amplify. However, in

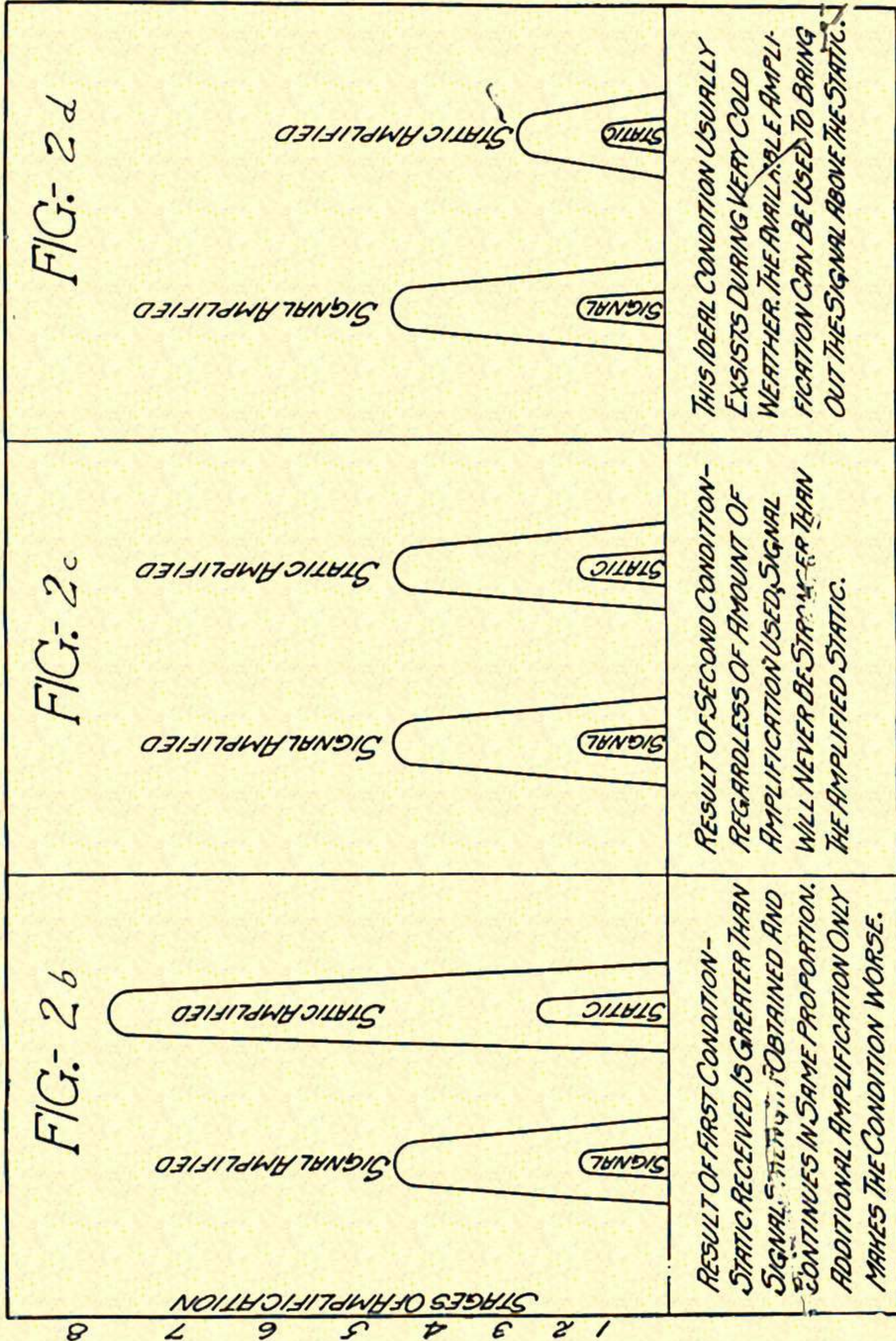

1 2 3 4 5 6 7 8
 STAGES OF AMPLIFICATION

Fig. 15

a three stage amplifier of this type it would be necessary to have three controls, as each stage must be in exact resonance with the incoming wavelengths. This disadvantage can be overcome ingeniously by mounting the three variable condensers on a common shaft and have them rotate simultaneously. In this manner the three stages are tuned through the use of one control. However, there is still a further disadvantage not so easily overcome. An ordinary inductance and variable air condenser in parallel will give a wavelength variation of approximately $2\frac{1}{2}$ to 1. For example, a certain inductance in parallel to a variable condenser having a maximum capacity of .0005 M.F. will tune from a wavelength of 200 to 510 meters. The same condenser with a larger inductance would tune from 400 meters to 1,000 meters.

In order to cover a wide wavelength range with the tuned method of amplification, it is necessary to have more than one transformer. By mounting a variometer and a variable condenser on the same shaft, a wavelength ratio of 8 to 1 could be obtained; for example, 150 to 1,200 meters, but this would entail special complicated design to enable functioning as a transformer. Further on, tuned radio frequency amplifiers are treated separately, especially for use in connection with Super-Heterodynes.

Armstrong reasoned that if it was difficult to amplify a signal at high frequencies, why not change the frequency to a lower value where radio frequency amplification could be carried on very efficiently and without difficulties. This is exactly what the Super-Heterodyne does, the incoming signal which may be any wavelength from say 160 to 850 meters, is changed to a higher wavelength, say 10,000 meters and the amplification carried on at that advantageous wavelength. On first thought, one would think that the change would destroy the pitch of a spark signal, or the reproduction of voice, but this is not true. The Super-Heterodyne method of reception gives the nearest approach to perfect reproduction of broadcast entertainments obtainable.

The Super-Heterodyne consists of three important sections, each one of which may be very simple, or very elaborate. First, there must be a means of collecting the incoming signal, such as a loop connected to an ordinary detector circuit, and means provided to tune the loop to that signal. Second, there must be a source of oscillations, the frequency of which can be varied from, say, 300,000 cycles to 2,000,000 cycles. Third, there must be an efficient radio frequency amplifier, adapted to be particularly efficient on a pre-determined frequency, for example, 10,000 meters.

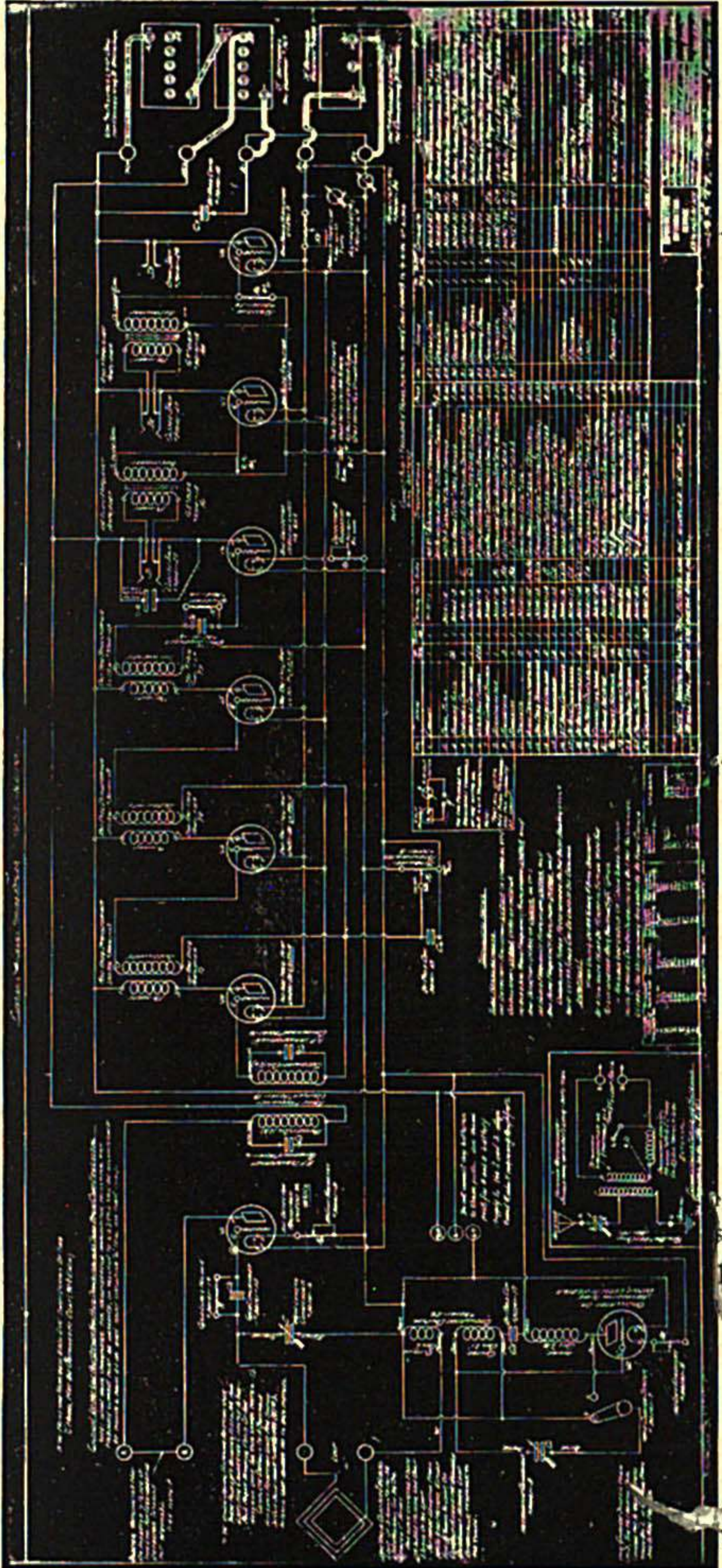

Fig. 164
Model "C" Super-Heterodyne Schematic Wiring Diagram.

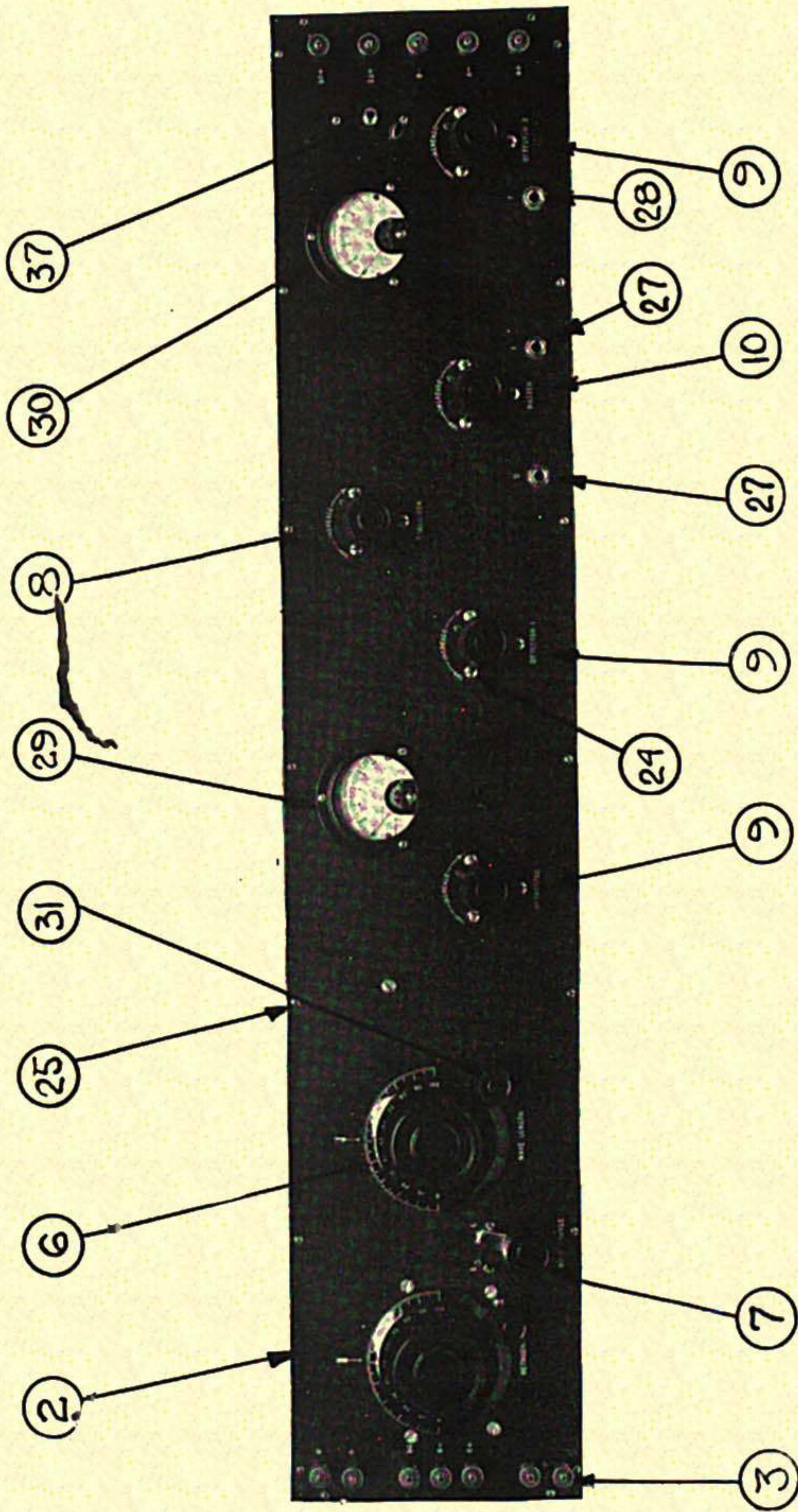

Fig. 17
Model "C" Front View.

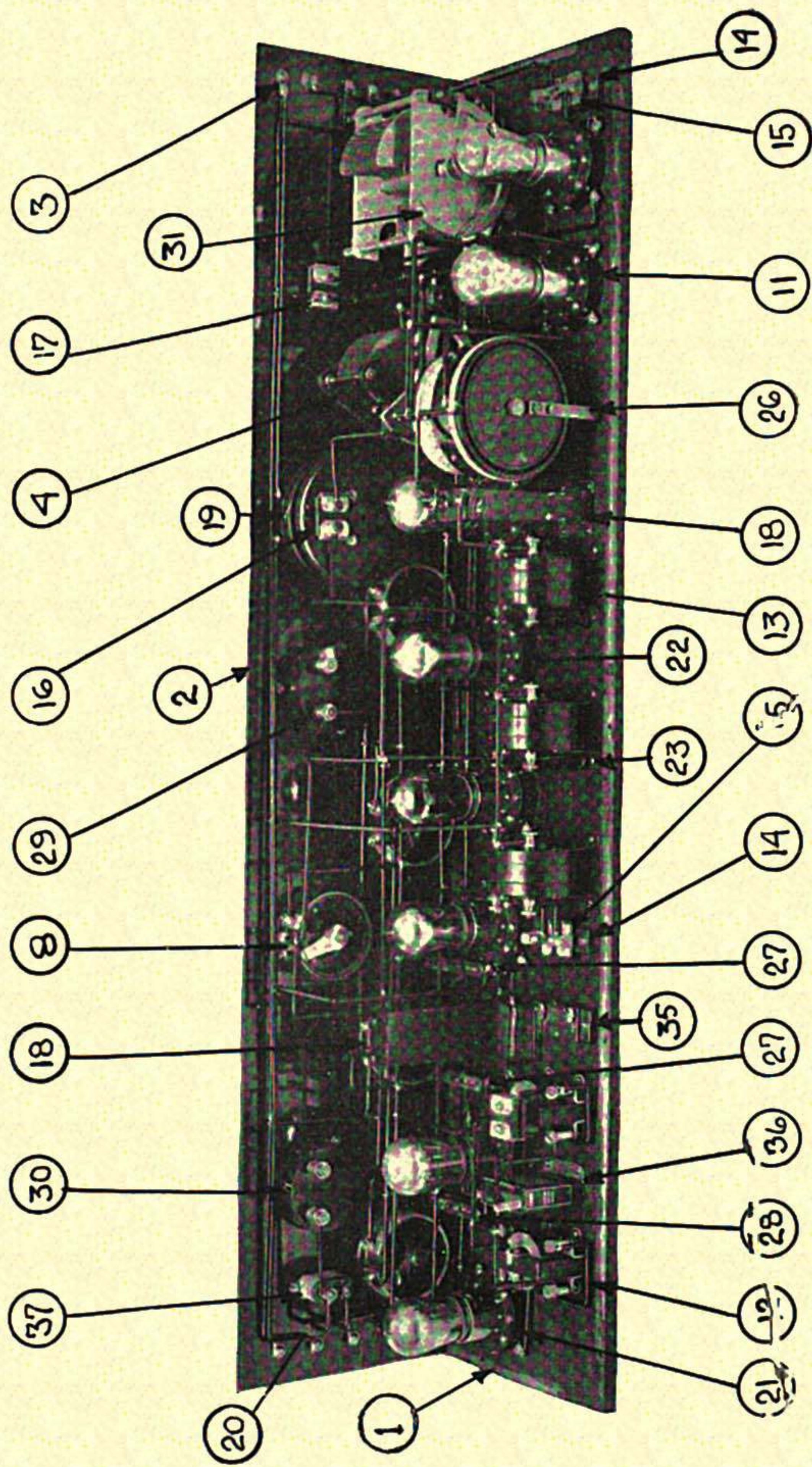

Fig. 18
Model "C" Rear Angle View.

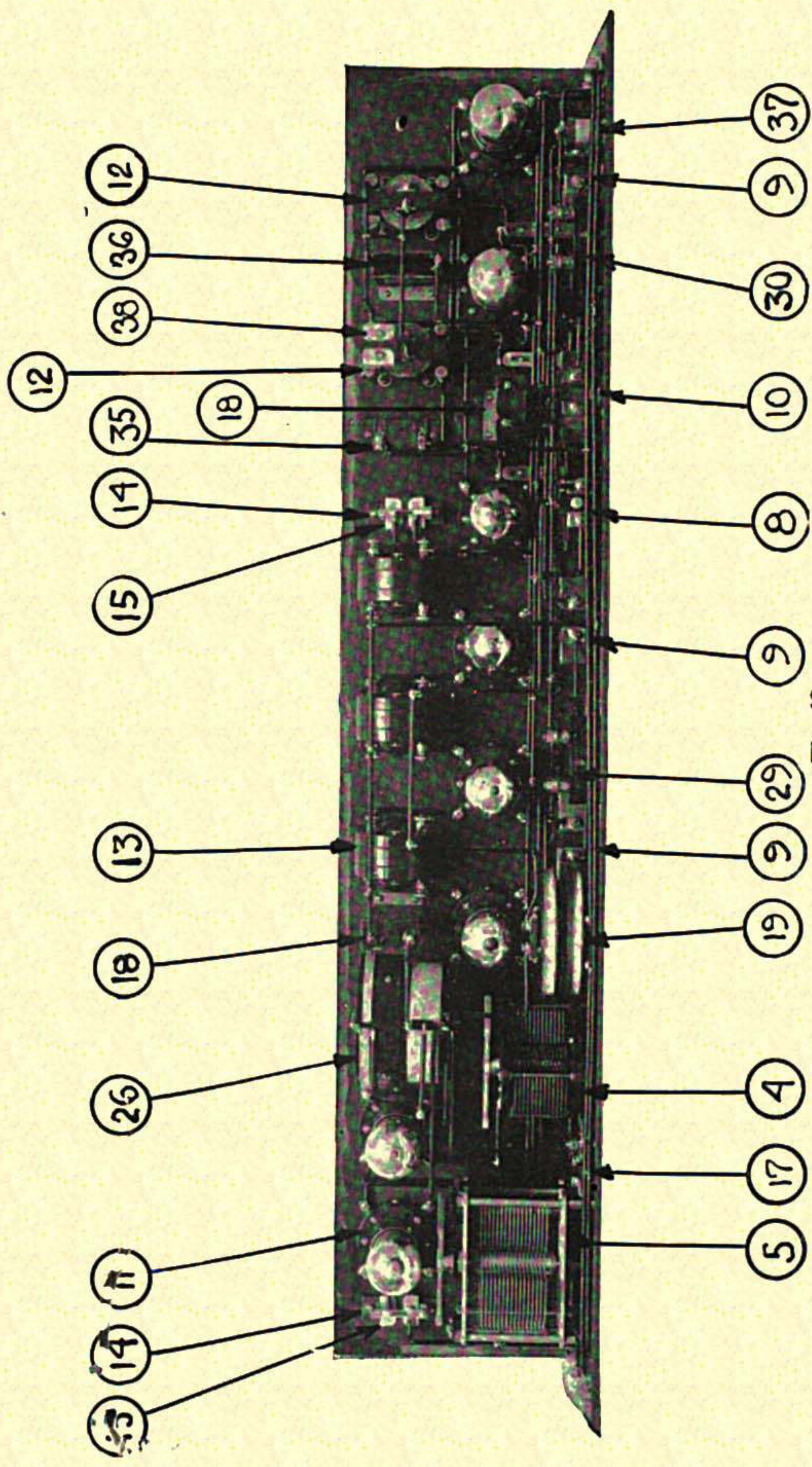

Fig. 19
Model "C" Top View

Before we describe the Super-Heterodyne action further, it may be well to describe the plain Heterodyne action. Fessenden discovered that if we had two independent sources of oscillations, each of a different frequency, there would be generated a third source of oscillations, the frequency of which would be the difference between the original two. For example, if one oscillator were working on 800,000 cycles and the second oscillator working on 801,000 cycles, there would be a resultant note of 1,000 cycles. Oscillations below a frequency of about 20,000 cycles are audible to the human ear. Oscillations above that frequency are inaudible.

Suppose, now, that a broadcast station is transmitting on 400 meters; this is equivalent to a frequency of 750,000 cycles, and that we have a loop tuned to this frequency and feed into a tube detector. Now, suppose we have a radio frequency amplifier adjusted to receive 10,000 meters (30,000 cycles) very efficiently, the input of this amplifier coupled to the plate circuit of the loop detector. Then if we adjust the local source of oscillations (oscillator) to 780,000 cycles or 720,000 cycles and couple same to interact with the oscillations in the loop, a third component of 30,000 cycles will be set up (an exact reproduction of the original signal) forced through the coupling device in the detector plate circuit and amplified at the radio frequency value of 30,000 cycles. At the end of the radio frequency amplifier must be placed a second detector tube to provide rectification to bring the signal to audibility. After the rectification, the signal may be still further amplified at audio frequencies.

A typical arrangement of tubes for such a receiver would consist of a first detector, local oscillator, three stages of radio frequency amplification, second detector and two stages of audio frequency amplification, a total of eight tubes. The schematic wiring diagram of this arrangement, known as the Model "C" Super-Heterodyne, is shown in Figure 16. The front view of the complete model is shown in Figure 17 and the rear view with cabinet removed in Figures 18 and 19.

Considering the Heterodyne action in more detail to enable it to be thoroughly understood. Suppose we strike the note C on the piano in one of the octaves, we hear a certain note; now if we strike the note A we hear a different note and if we strike both together, in addition to the original notes being there, a third note is heard, due to the original two.

Referring to Figure 20. Suppose Oscillator No. 1 is generating oscillations at the rate of 750,000 cycles corresponding to a wavelength of 300 meters. Now, if the receiver is tuned to 750,000 cycles, there

will not be any audible signal in the receivers as this frequency is above audibility. However, if Oscillator No. 2 is adjusted to 751,000 cycles or 749,000 cycles this third component of 1,000 cycles difference will be heard in the receiver. For another example, if oscillator No. 1 was set for 500 cycles and Oscillator No. 2 set for 560 cycles, there would be an audible note of 60 cycles, corresponding to the "hum" of a Tungar rectifier transformer. In actual practice of radio telegraphy, one source of oscillations comes from the transmitting station and a local source of oscillations used to provide the difference in frequency. This difference is called a "beat" and the note, the "beat note."

The receiver can be made to oscillate to form the second source of oscillations, but it is obvious that if the receiver is to produce oscillations of a different frequency than the incoming wave it must be tuned higher or lower than the incoming wave. This means that the receiver cannot be tuned to exact resonance with the signal and there is a loss of signal audibility. During the change of frequencies, or heterodyning action, an amplifying action takes place known as the "Heterodyne Amplification," amounting to 100 or 150 times amplification or almost equal to one stage of audio frequency amplification.

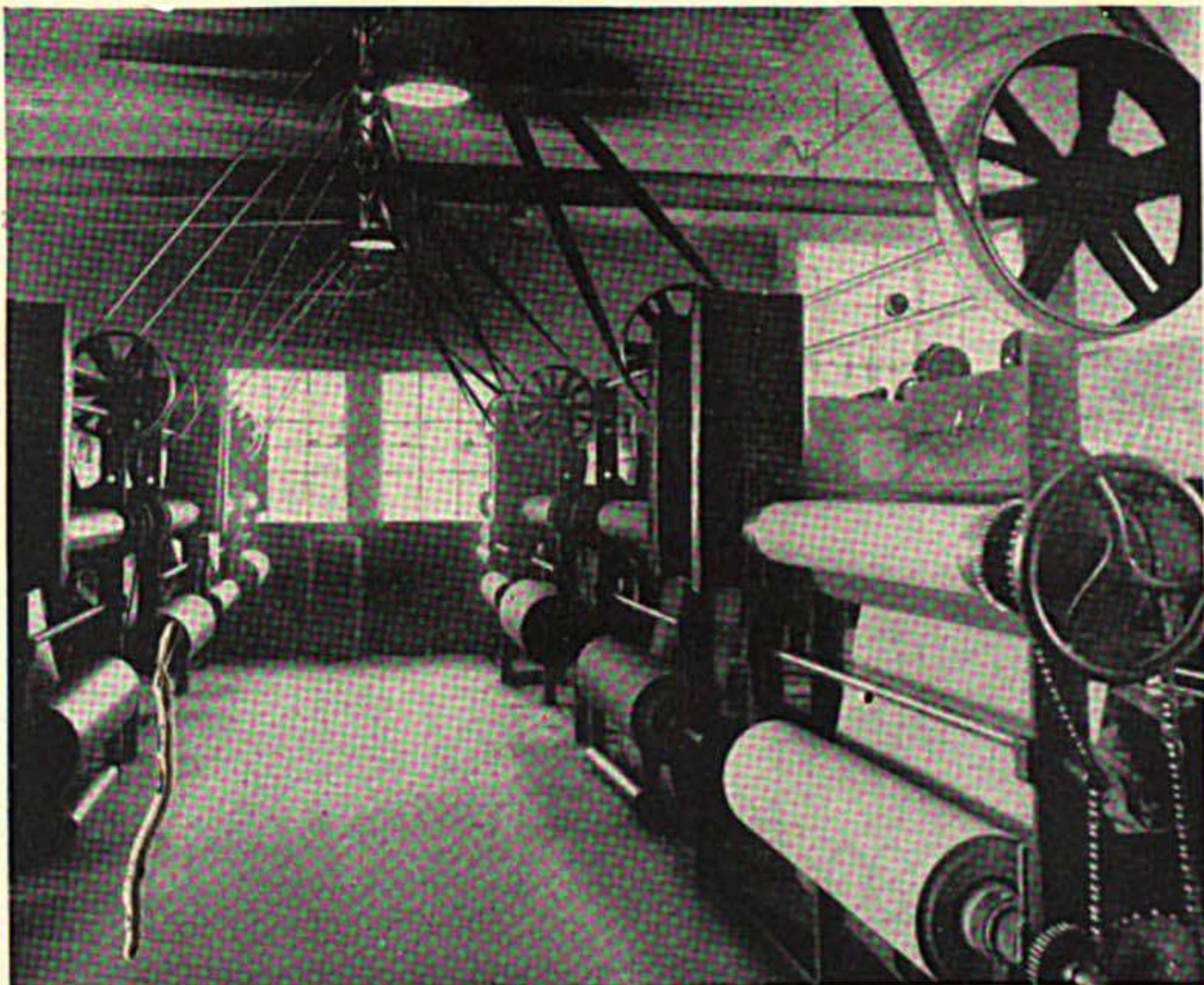

Manufacturing Formica.

The Treating Machines which impregnate the paper with Bakelite resins and dry the sheet.

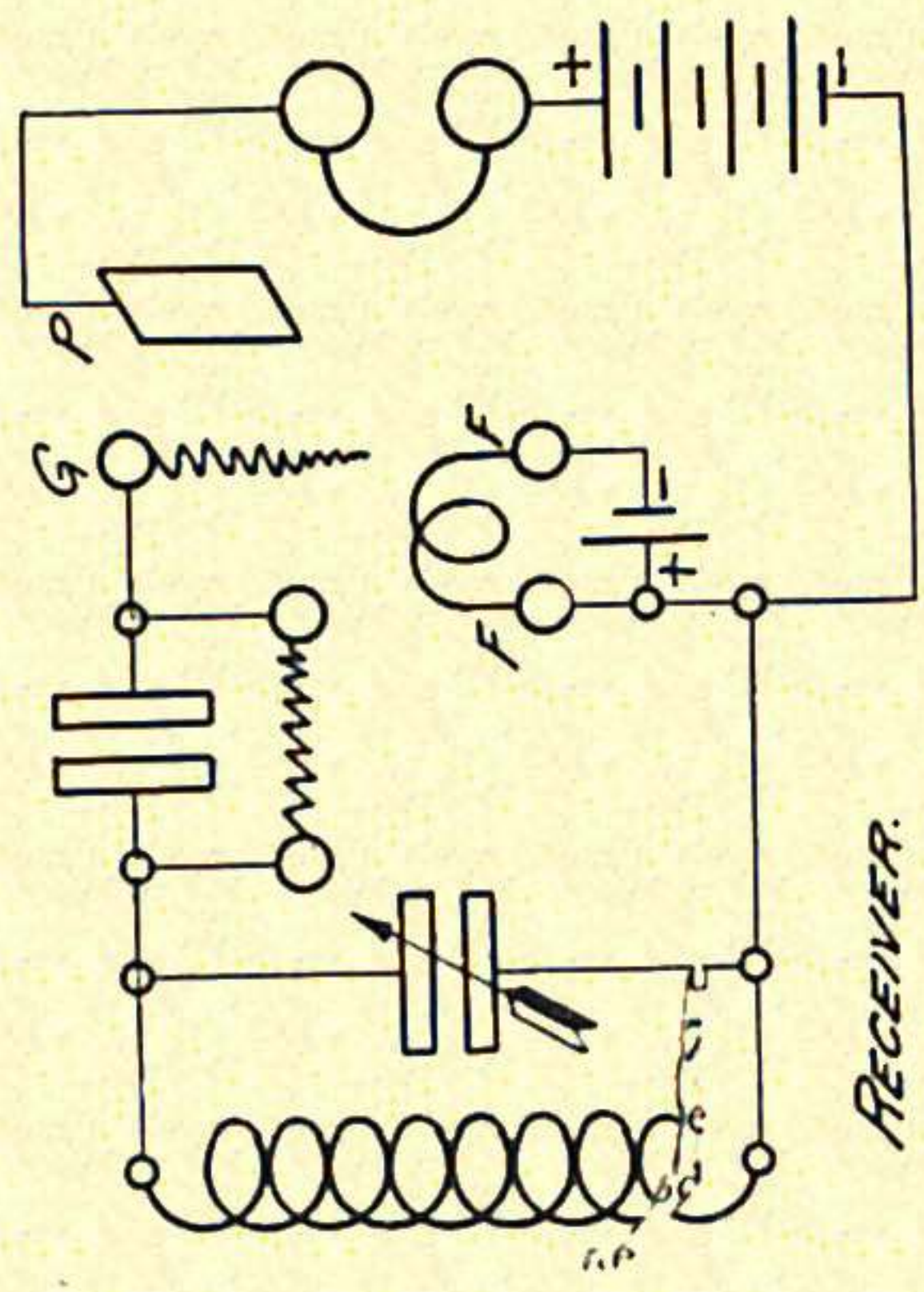
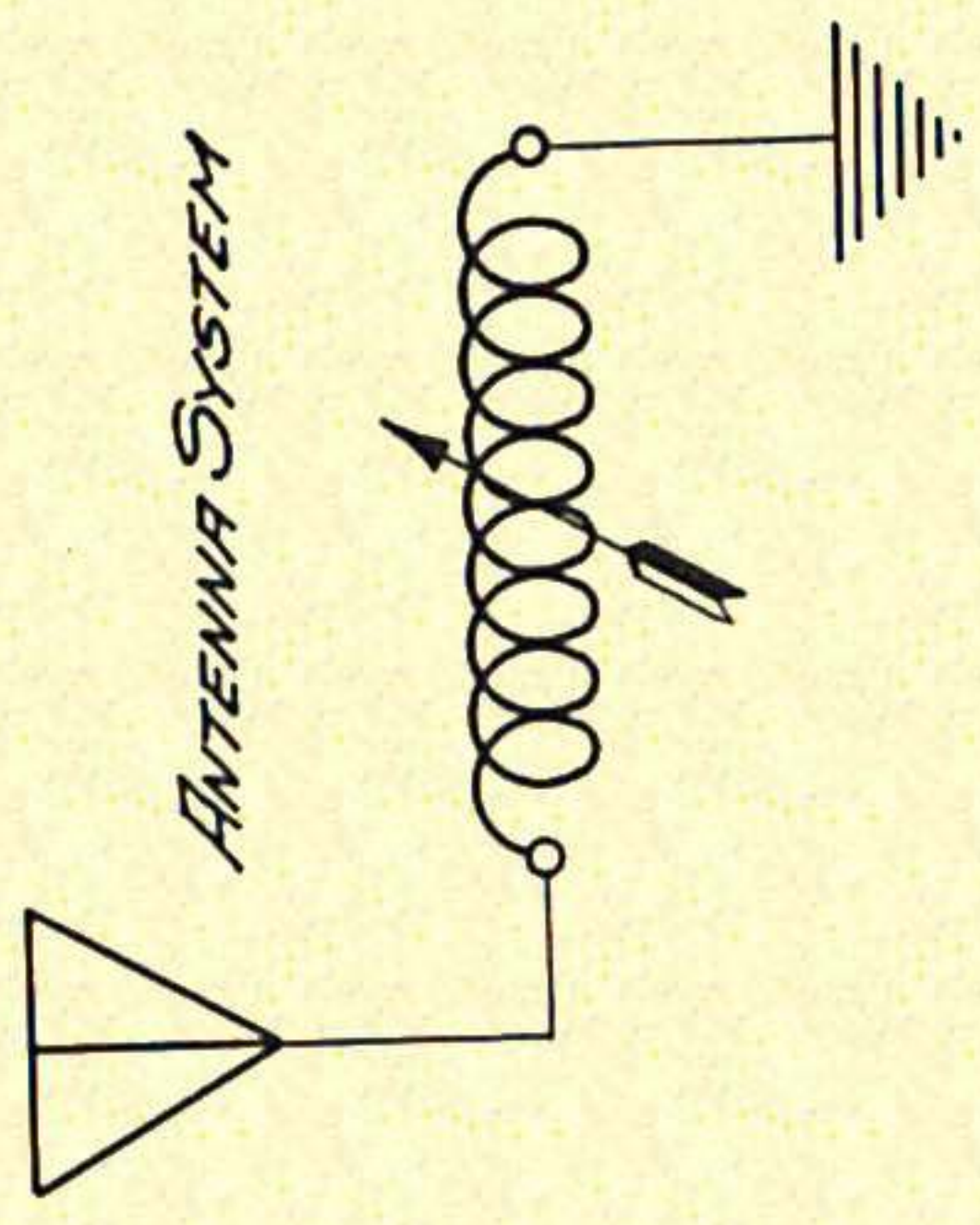
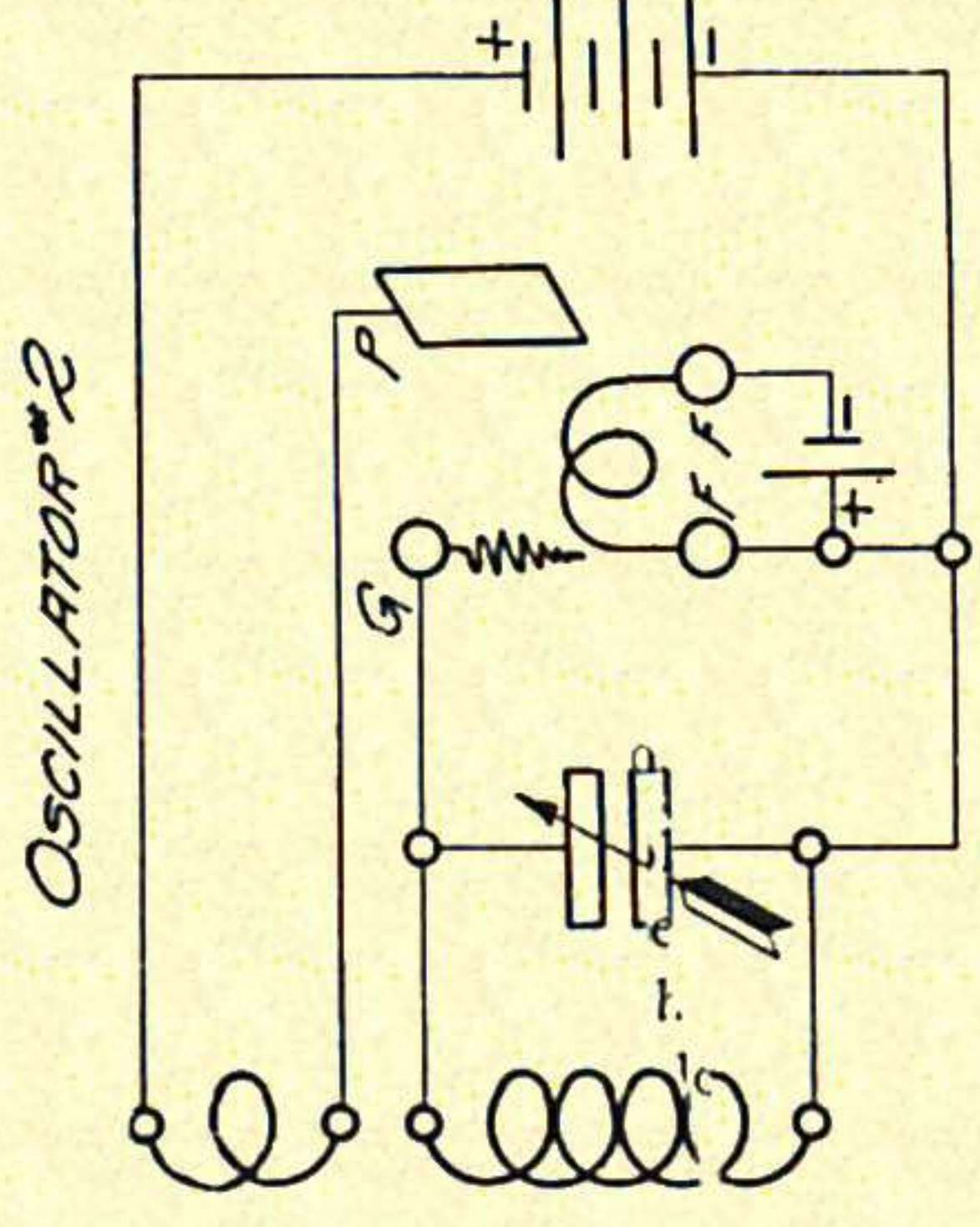
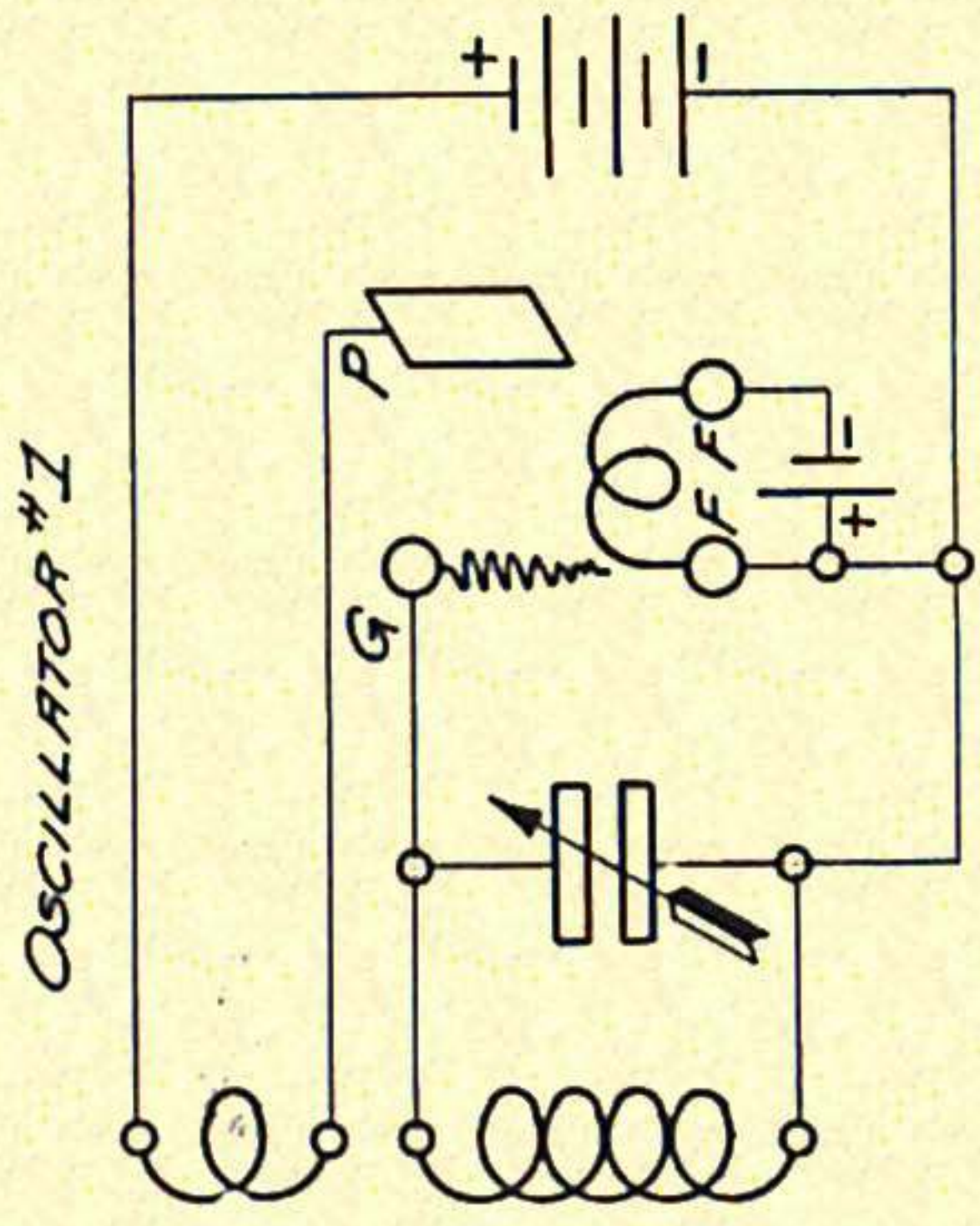

Fig. 20

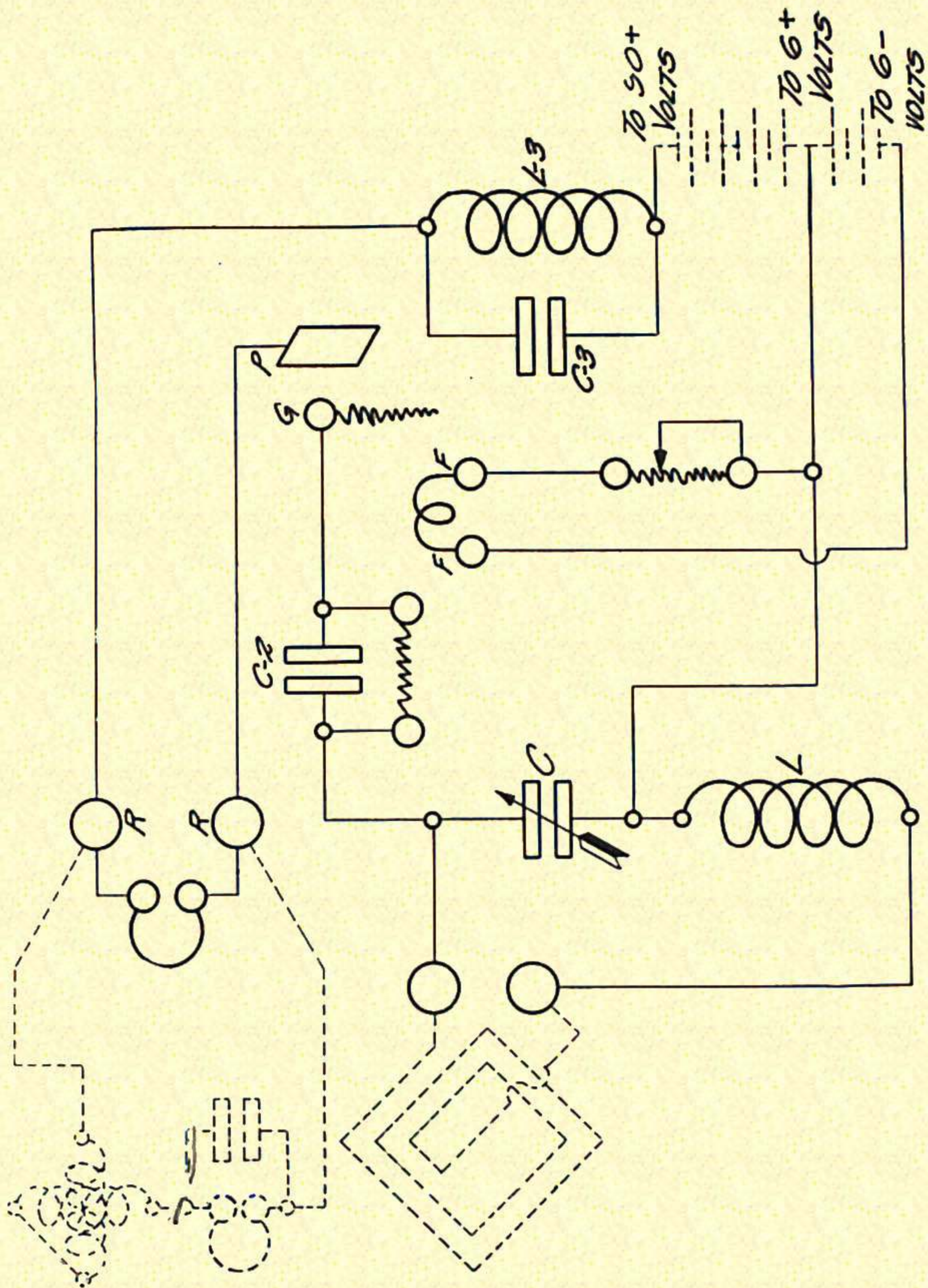

Fig. 21

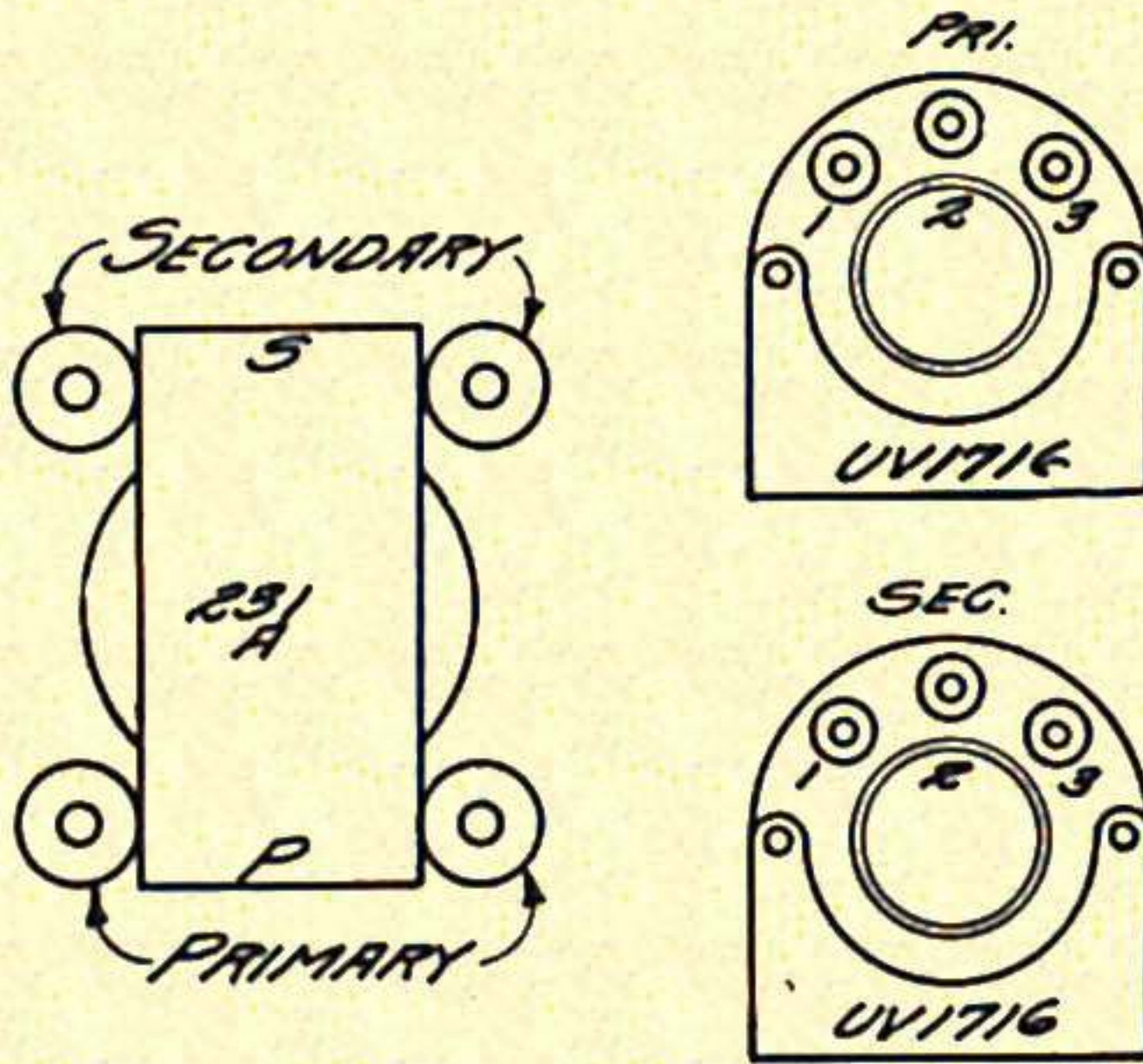
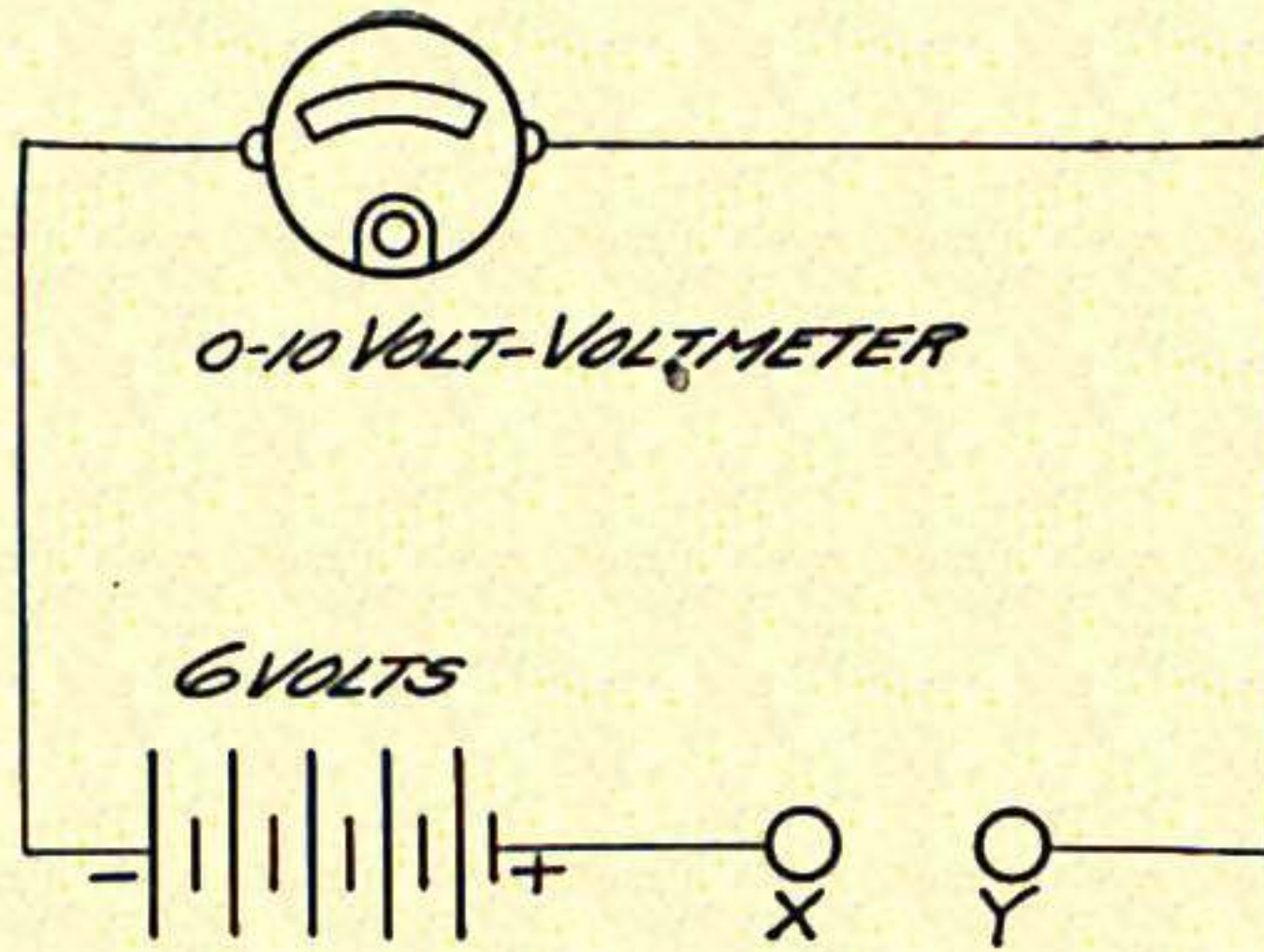

Fig. 22

Showing Method of Testing Instruments for Circuits.

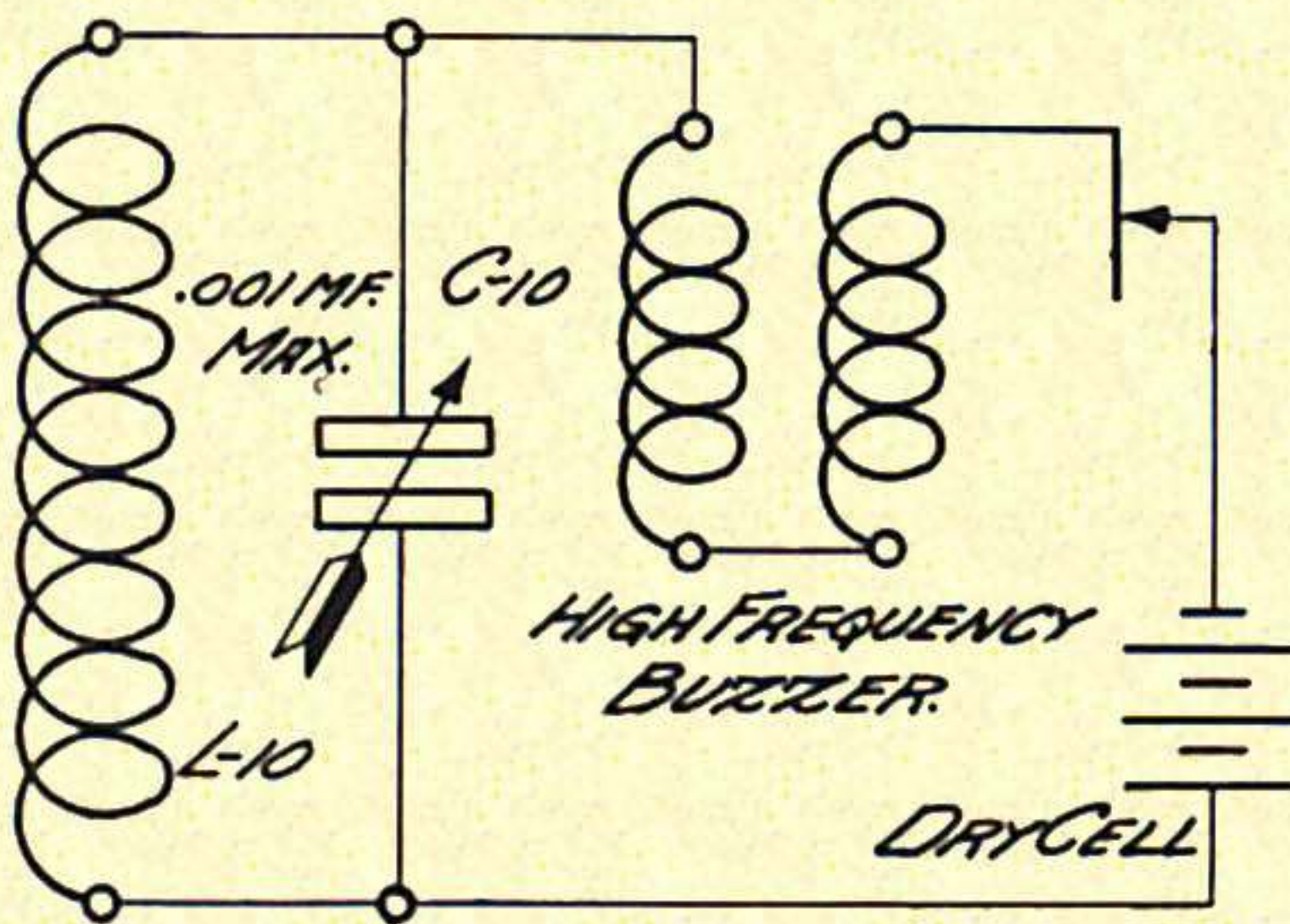

Fig. 22A

It must be remembered that if the incoming signal is modulated, or has decrement, it is not necessary to employ any local source of oscillations for an audible signal and a good operator will never use an oscillating detector to receive radio phone broadcast performances. The oscillating detector not only interferes with the neighboring receivers, but will not give good quality of reproduction or stability.

Likewise in a Super-Heterodyne the radio frequency amplifier must not oscillate. When the amplifier oscillates, beat notes are set up due to the difference between the amplifier frequency and oscillator frequency and this distorts the incoming signal. Oscillations are prevented by turning the potentiometer "Stabilizer" arm toward the positive side. A radio frequency amplifier tends to oscillate as the grids are placed negative, and maximum amplification is obtained at a point just below where oscillations start. A best adjustment for the relation between the filament temperature, plate voltage and grid bias potential will be found for good quality of reproduction. It is usually best to work the grids about 4 volts positive, corresponding to the potentiometer being placed 30 degrees in the increase direction.

It would be possible to operate with the radio frequency grid potential full to the negative side of the battery. The only advantage would be a reduction in plate current, but it would not give increased amplification. As this negative potential creates undesirable oscillations in the amplifier, it is necessary to compensate for this action. The oscillations are due to grid-plate coupling either in the individual tubes or even between the different tubes in cascade through the improper distribution of connecting wires. The tube capacity coupling may be neutralized by the Hazeltine method or several other methods that give the same effect. However, as just pointed out, this will not increase the amplification and on the other hand unless the transformers are of very special design, there will be a very noticeable reduction in the amplification obtained.

In Figures 17, 18 and 19 the numerals correspond with the Bill of Material as follows; the prices mentioned are the current market prices for these parts as obtainable in leading stores.

It might be well to mention here that according to the patent license agreements, it is not permissible for a store to offer a complete set of parts as being a set of Super-Heterodyne parts. Still the amateur or experimenter is given the right to construct a set for his own use and it is best for him to order the parts itemized and not specify a set of Super-Heterodyne parts. When ordering itemized parts, these

SUPER-HETERODYNE, ADVANCED MODEL "C"
Do Not Depart From These Specifications by Substituting
LIST OF NECESSARY PARTS

No.	Quantity	SPECIFICATIONS	PRICE
1	1	Cabinet, African Mahogany, Dark Finish, 40"x8"x7 $\frac{1}{4}$ ", 1/2" stock, hinged top, removable base.....	\$14.00
2	1	Panel, Grade "M" Black Formica, 40"x8"x1/4" Plain.....	9.60
3	12	Binding Posts, Brass, Nickel Plated, General Radio Co., Type 138X.....	1.80
4	1	Variable Air Condenser, .00027 M.F. Max. Special Shaped Plates, E. I. S. Type.....	4.75
5	1	Variable Air Condenser, .001 M.F. Max. General Radio Co., Type 247B with Special Long Shaft.....	4.00
6	2	4" Dial with Knobs, Improved Type E. I. S.....	3.00
7	1	Wave Chance Switch, General Radio Co., Type 139A with 2-138D Contacts and 2-138C Stops.....	1.13
8	1	Potentiometer "Stabilizer" 400 OHM, General Radio, Type 214A.....	3.00
9	3	Rheostats, 20 OHM Each, General Radio, Type 214A.....	6.75
10	1	Rheostat, 7 OHM, General Radio, Type 214A.....	2.25
11	8	Sockets, General Radio, Type 156.....	8.00
12	2	Audio Frequency Amplifying Transformers, General Radio, Type 231A.....	10.00
13	3	Radio Frequency Amplifying Transformers, Special, see Blue Print.....	25.50
14	2	Grid Leaks, 2 MEGOHM, Radio Corp., Model UP 523, 2 UX 543 Holders.....	2.50
15	2	Grid Condensers, .00025 M.F. Each, Dubilier Type 601.....	.70
16	2	R. F. Trans. Condensers, .00025 M.F. Each, Dubilier Type 601.....	.70
17	1	By-Pass Condenser, .001 M. F. Dubilier Type 601.....	.40
18	2	By-Pass Condensers, 1 M.F. Each, Western Electric Co., Type 21K.....	4.00
19	1	Radio Frequency Coupler, Special, E. I. S. Type.....	6.00
20	30	Feet No. 12 B. & S. Gauge Tinned Copper Wire, Soft Drawn Round.....	.60
21	30	Feet No. 12 Black Empire Cloth Tubing.....	3.30
22	16	Socket Screws No. 6 R. H. Iron, N. P. 7/8" Long.....	.32
23	20	Transformer Screws No. 8 R. H. Iron, N. P. 3/8" Long.....	.30
24	15	Rheostat Screws No. 8-32 Oval Head Brass, N. P. 3/4" Long.....	.30
25	18	Panel Screws No. 6 RD. HD. Iron, N. P. 3/4" Long.....	.30
26	1	Oscillator Coupler, Special E. I. S. Type.....	6.00
27	2	Closed Jacks, Premier Type No. 131, Adjustable.....	1.90
28	1	Open Jack, Premier Type No. 133, Adjustable.....	.65
35	1	.005 Dubilier Condenser, Type 601.....	1.00
36	1	4 1/2 Volt Bias Battery, Type 751.....	.40
			<hr/> \$123.15
29	1	Voltmeter, 0-10 Volts, D. C. Flush, Black Finish, Weston Pattern No. 301.....	\$8.00
30	1	Ammeter, 0-5 Amps., D. C. Flush, Black Finish, Weston Pattern No. 301.....	8.00
31	1	Geared Vernier Attachment for "Heterodyne" Condenser.....	3.50
32	1	Drilling Panel as per Blue Print, Labor.....	2.00
33	1	Graining Panel, Satin Finish, Gorton Machine, Engraved Lettering, Labor.....	8.40
34	2	Special Resistor and Holders.....	2.50
37	1	Western Electric Filament Switch, Push-Pull Type 7 A.....	2.00
			<hr/> \$34.40

EXTRA PARTS (Desirable But Not Essential)

29	1	Voltmeter, 0-10 Volts, D. C. Flush, Black Finish, Weston Pattern No. 301.....	\$8.00
30	1	Ammeter, 0-5 Amps., D. C. Flush, Black Finish, Weston Pattern No. 301.....	8.00
31	1	Geared Vernier Attachment for "Heterodyne" Condenser.....	3.50
32	1	Drilling Panel as per Blue Print, Labor.....	2.00
33	1	Graining Panel, Satin Finish, Gorton Machine, Engraved Lettering, Labor.....	8.40
34	2	Special Resistor and Holders.....	2.50
37	1	Western Electric Filament Switch, Push-Pull Type 7 A.....	2.00

MODEL 'C' SUPER HETERODYNE
WAVELENGTHS WITH AG-1380 LOOP

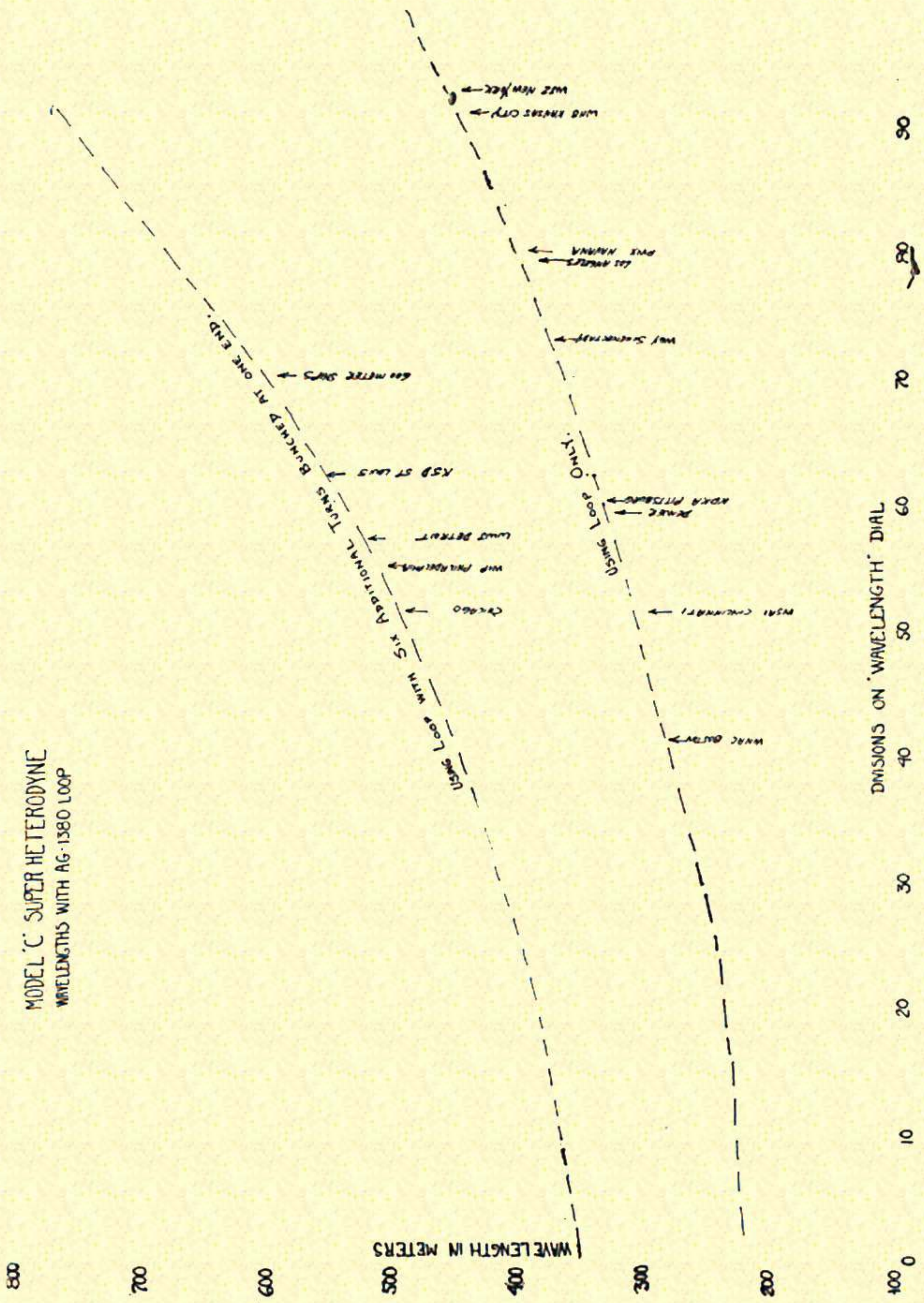

Fig 72

MODEL 'C' SUPER-HETERODYNE
 WAVELENGTH RANGE OSCILLATOR
 'HETERODYNE' DIAL.

Lower dial

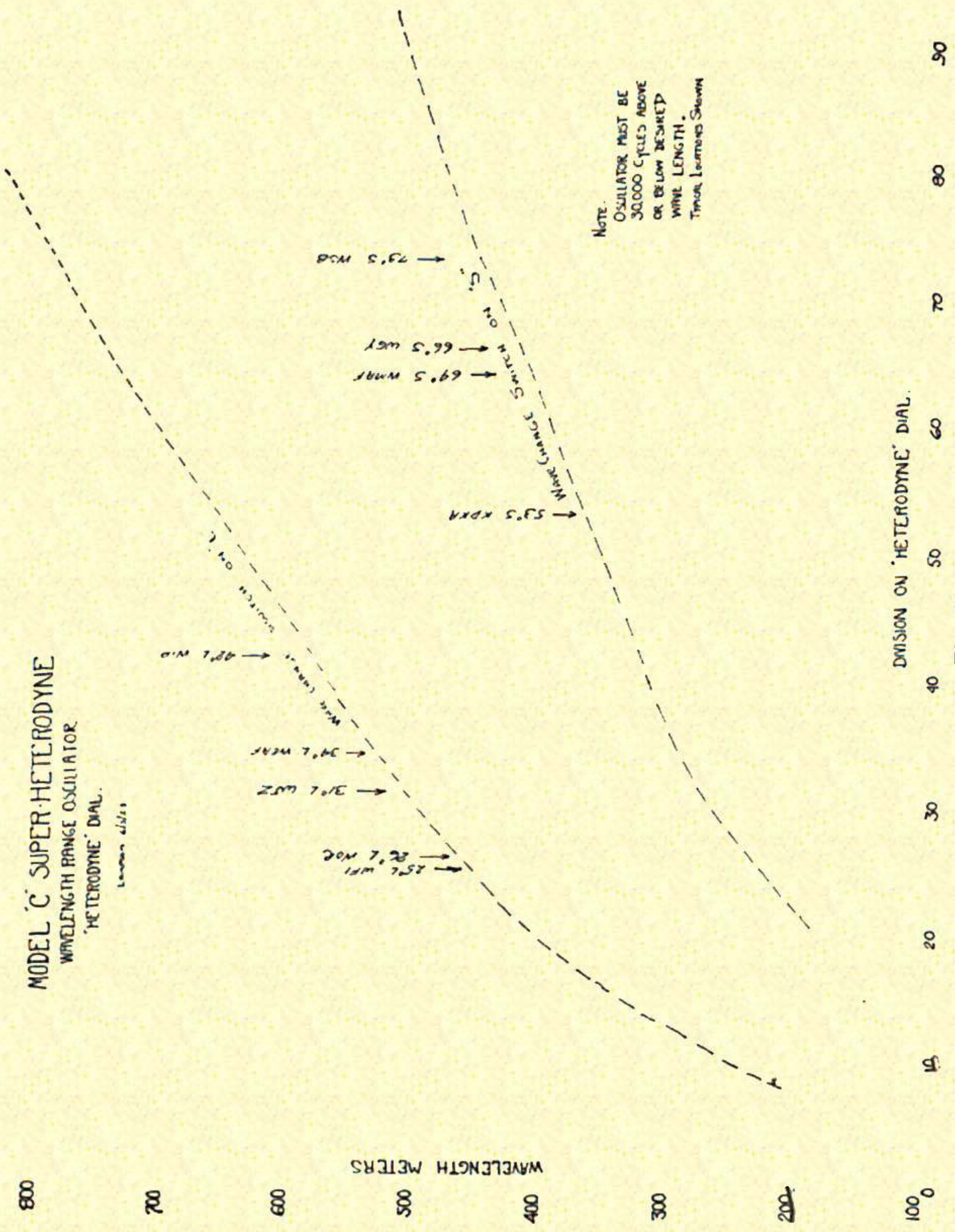
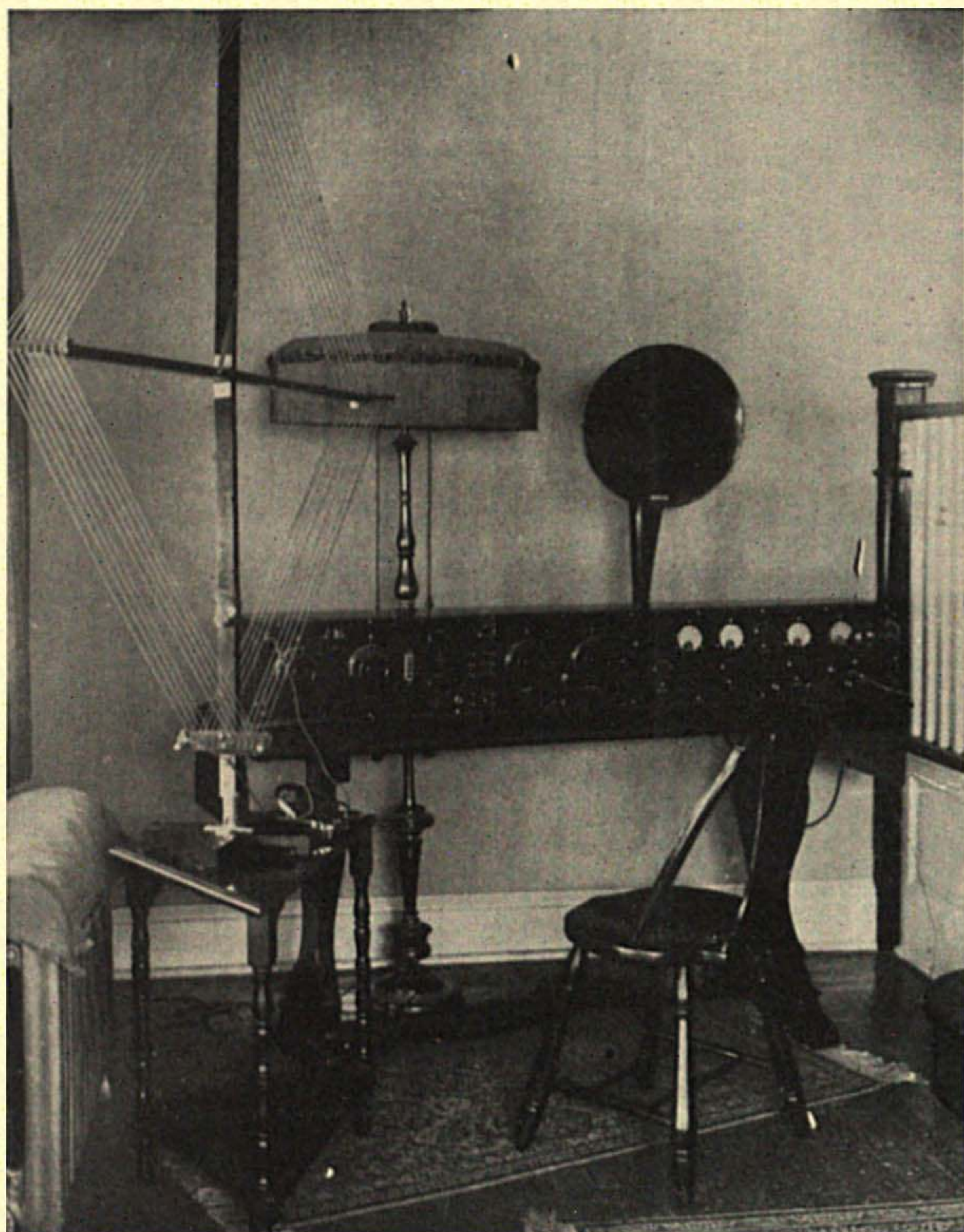
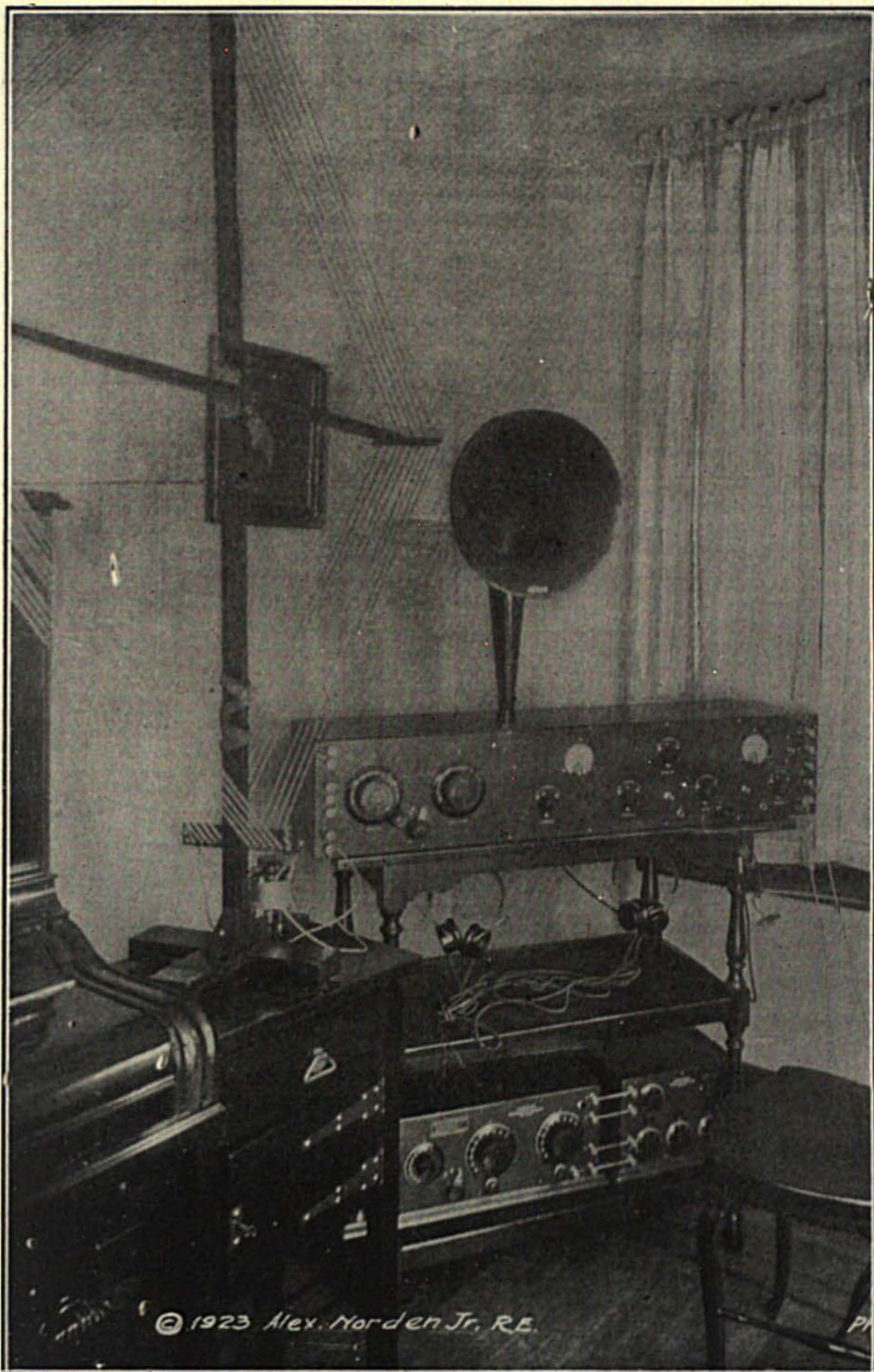

Fig. 24



Super-Heterodyne Installation consisting of Model C with Model J Two-Stage Direct Radio Frequency Amplifier, arranged for Loop or Antenna. Western Electric 10D Loud Speaker.



© 1923 Alex. Norden Jr., R.E.

Fig. 27



Fig. 28

parts can be used for any number of non-infringing uses and in this way the dealer or store is not jeopardized in any way.

Figure 16 shows the schematic wiring diagram of the Model "C" Super-Heterodyne, a popular model now widely used for long distance broadcast reception. This type of diagram is designated schematic as the various parts are shown as symbols. The symbols may be identified by referring to the Bill of Material. The circuit as shown is arranged for loop reception.

Suppose that we first insert the telephones between the binding posts R and R, disconnecting the link that was originally there. Now, if a loop is connected to the loop binding posts, a detector tube inserted at V-1 and the A and B batteries connected, we have a single circuit receiver with only a detector tube. This simple receiver is tuned to the transmitting station's wavelength by adjusting the Wavelength Dial controlling condenser C. However, it must be remembered that a given loop and variable condenser will only tune over a certain wavelength range depending upon the loop inductance and condenser capacity. For example, a standard Radio Corp. loop type AG-1380 has 9 turns on a 3 foot square, turns spaced 1 inch apart placed in parallel to a variable condenser of .00027 M.F. maximum, will tune from 220 meters to 450 meters. To receive lower wavelengths it is necessary to either use a smaller number of turns or a smaller variable condenser. It would of course be possible to use the same number of turns on a smaller diameter which would be the equivalent of decreasing the loop inductance. It must be remembered that the effectiveness of a loop increases fourfold as the diameter is doubled and in view of this the larger diameter is more desirable.

Experimenters within 15 to 25 miles of a broadcasting station can experiment with this single circuit one tube portion of this set, and in this manner predetermine the exact setting of the wavelength dial for various wavelengths. For example, using a Radio Corp. AG-1380 Loop with short leads, the wavelengths for different dial settings will be as follows in the "C" Model:

Dial Setting	Wavelength Loop Circuit
0	220 meters
30	280 meters
70	455 meters
100	498 meters

These values will vary with individual loops, condensers, connecting leads, etc. For the reception of wavelengths above 498 meters, the

following methods may be used: 1. Insert a standard variometer in series with the loop. 2. Connect a .005 M.F. Max. variable air condenser in parallel to the loop. 3. Add 6 turns to the loop, bunched together at one end and connected to form a coil of one continuous direction. Any one of these methods will enable reception of wavelengths as high as 825 meters approximately. It must be remembered, however, that when this change is made that lower wavelength then obtainable is correspondingly higher, so provision must be made to include or exclude the additional load to give access to either band of wavelengths. Of the three methods of loading mentioned, the addition of turns is the best, as the extra turns assist in picking up more received energy, from the transmitted signal.

A still stronger signal can be obtained in this one tube loop circuit, by employing regenerative amplification in the detector circuit. Instead of connecting the phones between binding posts R and R, connect a variometer and the phones in series and connect these two to posts R and R. Now, if the variometer is set at minimum or O, and the signal tuned in to full strength with variable condenser C, this signal can be amplified by adjusting the variometer until the plate circuit of the tube is tuned to the same wavelength as the incoming signal. This is called regenerative amplification. If a by-pass condenser of about .005 M.F. is placed across the phones greater amplification can be obtained. The phone windings tend to prevent the radio frequency currents from flowing freely through them and we have to rely on the capacity of the phone cords for a by-pass condenser, unless an additional condenser is used as shown in Fig. 21.

Suppose, now, we set the variometer at O so that there will not be any regenerative amplification, and instead we put the Oscillator Tube V-2 in operation. It will be found that when adjusting this oscillator and it approaches the wavelength of the incoming signal, that the signal is amplified. This phenomena is called "Heterodyne Amplification" and amounts to about 100 to 150 times, or nearly equal to one stage of audio frequency transformer coupled amplification.

It is quite possible to combine the regenerative amplification and heterodyne amplification, but it will be found in actual experiments that, after obtaining the heterodyne amplification, the additional increase in signal obtained by further regenerative amplification at this point will not be worth the extra equipment and bother. A regenerative first detector in a Super-Heterodyne is not recommended at all, for reliable and consistent performances, except in the C-7 design.

In the event that the heterodyne amplification and beat notes between incoming signal and oscillator are not noticed in the phones during these experiments, the trouble, of course, is in the oscillator circuit. Some tubes are very poor oscillators and others are excellent. It is well to try several tubes to select the most suitable for this work.

Now that we have determined that the loop and oscillator circuits are in a satisfactory working order, we can center our attention on the radio frequency amplifier. The first thing to do is to test the radio frequency transformer primaries and secondaries for continuity of circuit. These instruments are very delicate and while they are tested before shipment, they may be damaged in transit. As per Fig. 22, connect primary terminal No. 1 to X and primary terminal No. 2 to Y. If the battery is 6 volts, the voltmeter will read slightly less than that. If there is no voltmeter reading the primary is defective and should be returned for replacement. Test the secondary in the same manner. The audio transformers can be tested in the same manner, connecting either the two primary or secondary terminals to points X and Y for a reading. The reading on the secondary side will be much less than on the primary terminals, due to the greater resistance of the secondary windings. The audio transformers can be tested for grounds by connecting Y to the iron core of the transformer and connecting X to each of the four terminals in succession; there should not be any reading at any of the four points. A reading at any of these four points would indicate that the terminal was not insulated from the iron core.

The various condensers can be tested for short circuit by connecting the two condenser terminals to points X and Y. As a condenser will not pass direct current, there should not be any reading. However, if the condenser were large, say 1 M.F., and the testing voltage large, say 100 volts, the meter would give a small kick as the condenser charged. This is perfectly all right and does not indicate a defective condenser.

To properly test the radio frequency amplifier, an artificial source of signals variable from five thousand to 12,000 meters is required. A standard buzzer driven calibrated wavemeter is very satisfactory. For temporary use an arrangement as shown in Fig. 22A will answer the purpose. The inductance consists of a 750 turn duo-lateral coil, the condenser a .001 M.F. Max. variable air condenser, such as a General Radio Co. Type 247 or 239. A buzzer and dry cell are connected as shown.

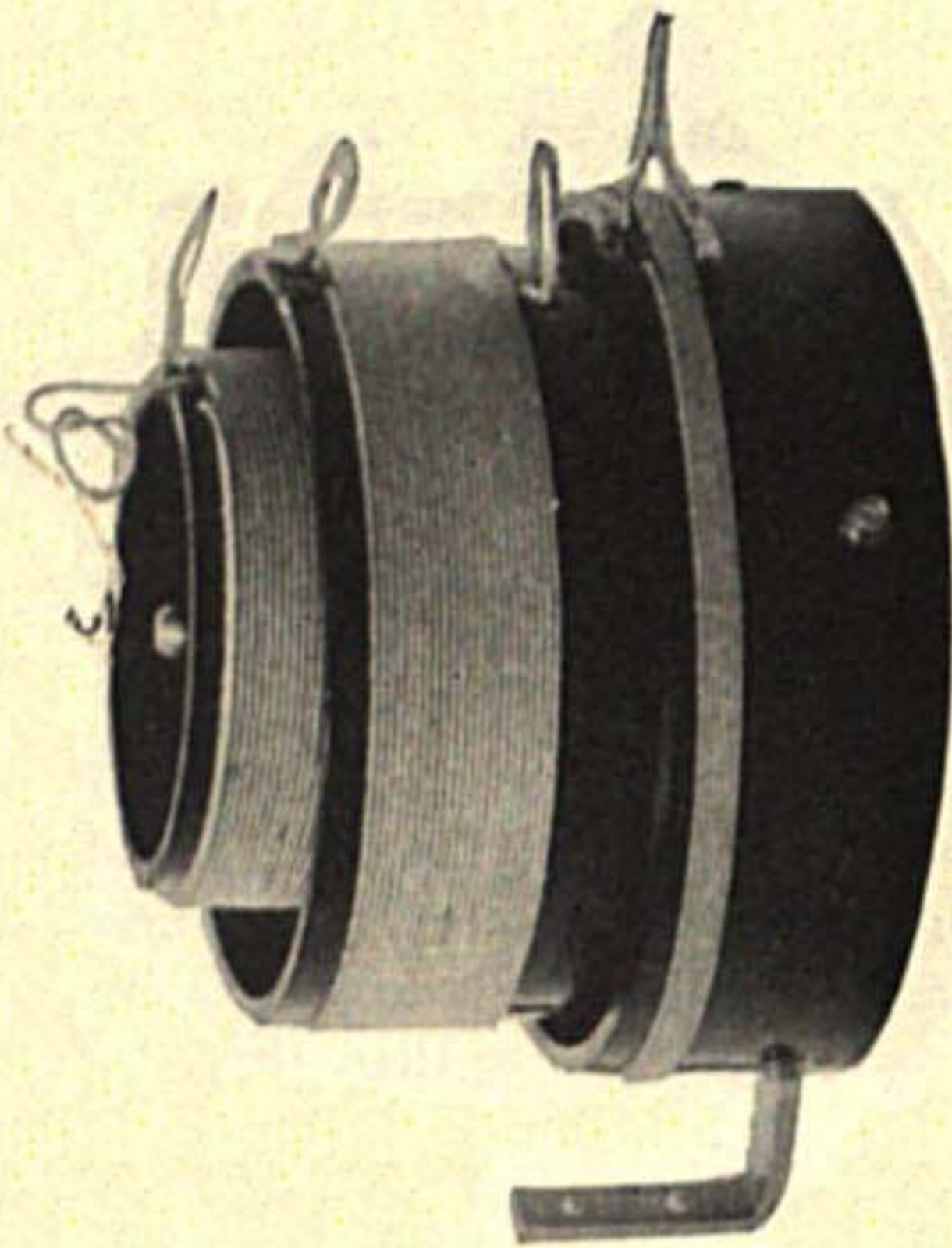

Fig. 29 "C" Oscillator Coupler.

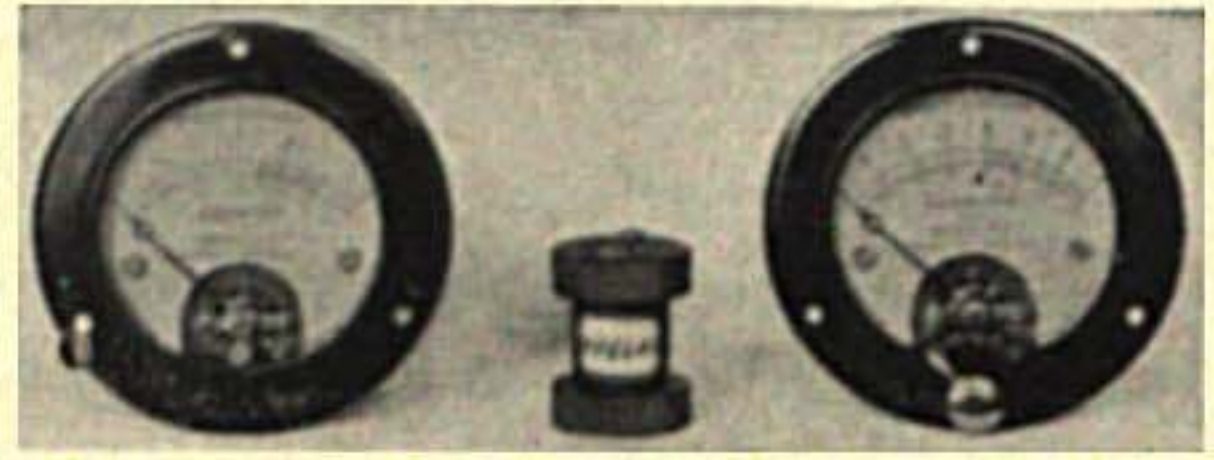

Fig. 30 Jewel Meters

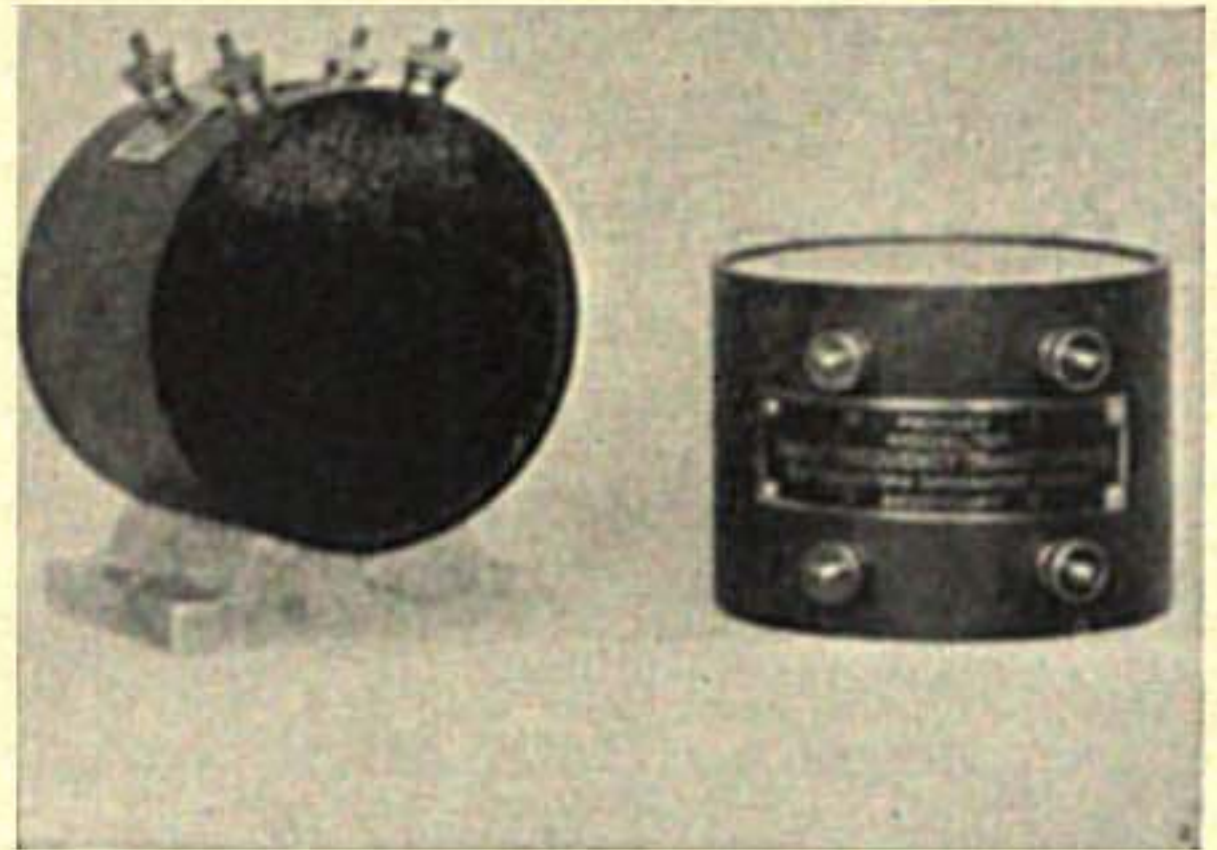

Fig. 31 "C" R.F. Transformer.

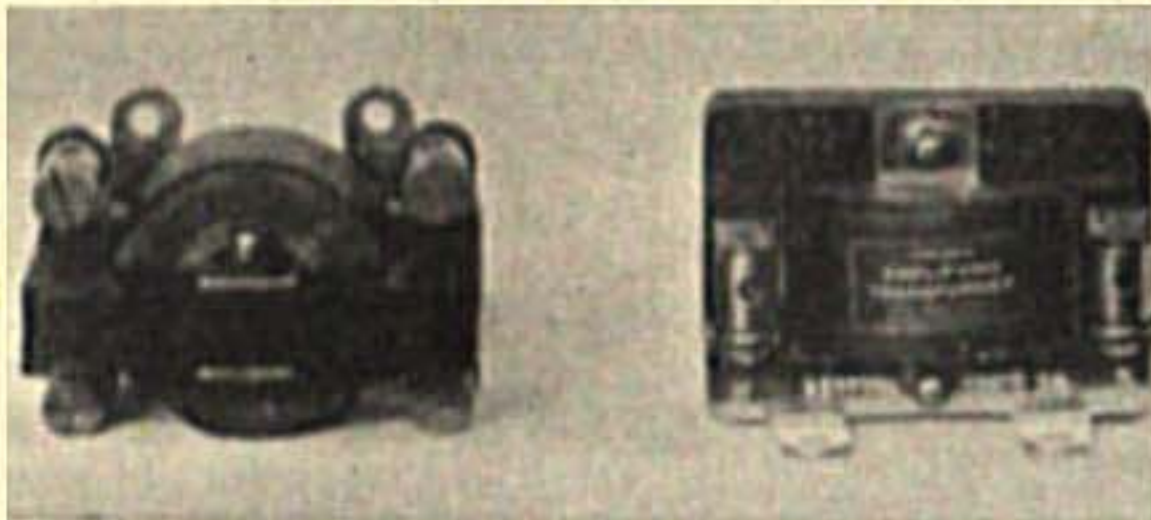

Fig. 32 G.R. Audio Transformers.

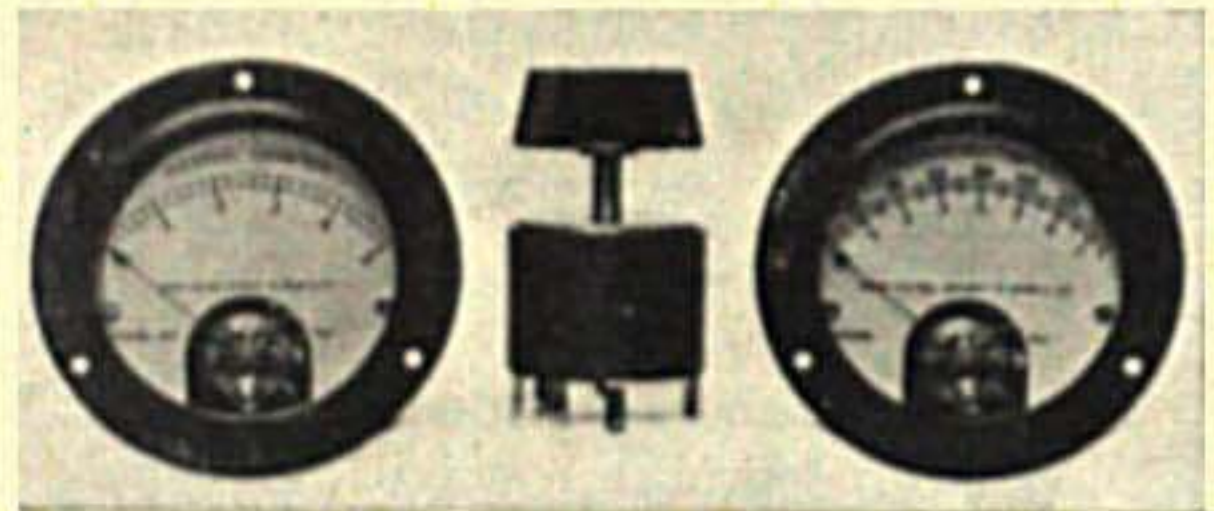

Fig. 33 Weston Meters

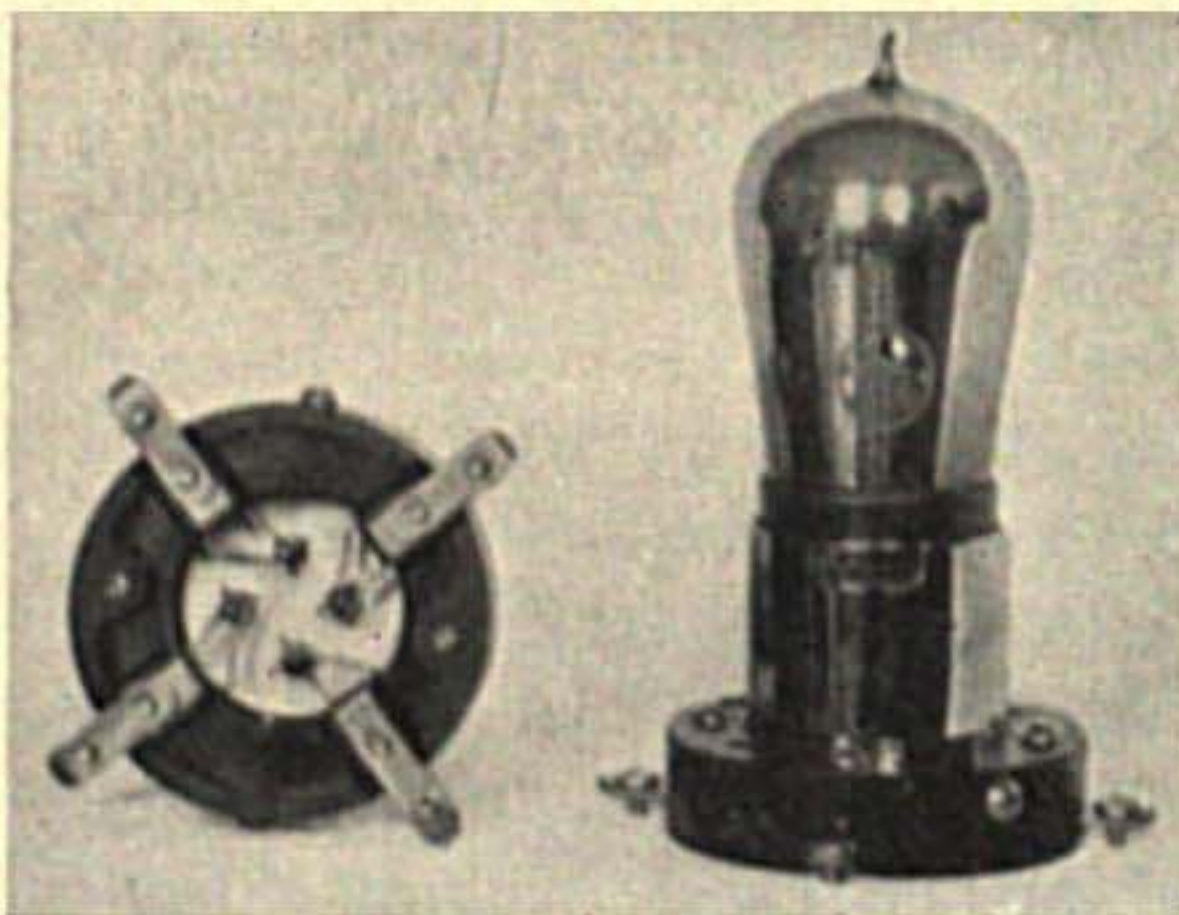

Fig. 34 G.R. Socket.

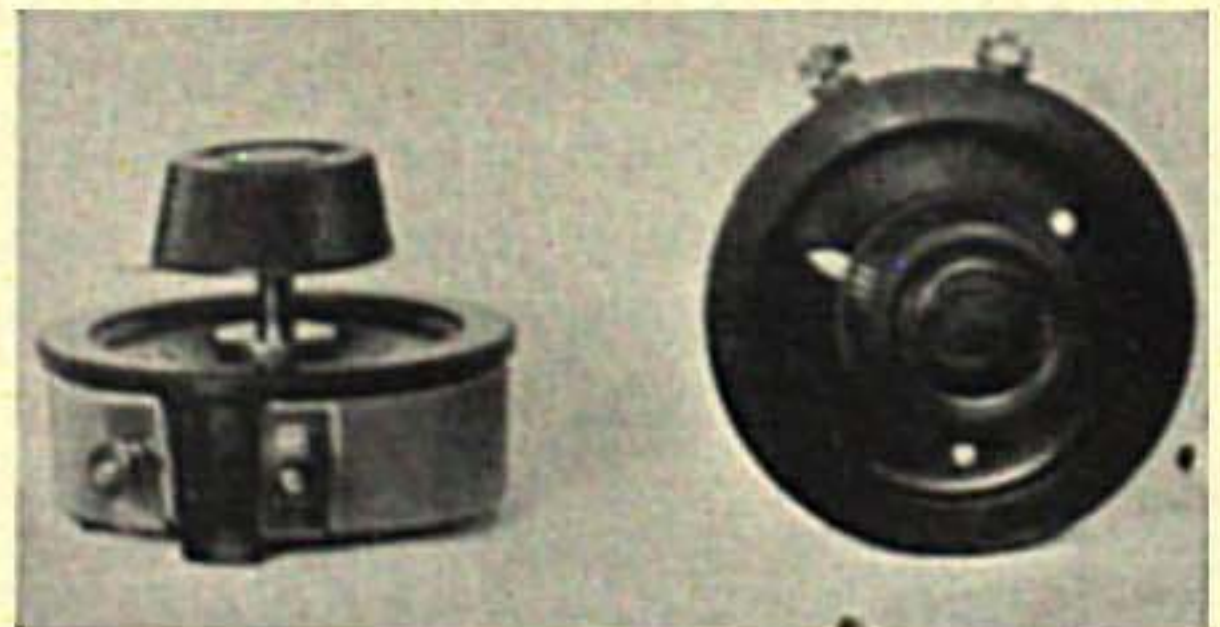

Fig. 35 G.R. Rheostat.

To test the amplifier, tubes V-1 and V-2 are removed from their sockets, and V-3 to V-8 are inserted and then both batteries applied. Insert the phones at Jack J-1. Regulate the Master rheostat until the filaments are fairly bright. Now by placing our temporary wavemeter about three or four feet from the coil L-4 and varying the condenser C-10 a point will be reached when a maximum signal will be heard in the phones. During this test the Stabilizer potentiometer should have the arm turned to the positive side, to prevent the amplifier from oscillating. It will be noticed that, when the stabilizer arm is turned to the negative side an increase in amplification is obtained up to a point where the tone changes and is distorted. This change and distortion of damped signals indicates that the amplifier is oscillating. Maximum amplification is obtained just below the point where oscillations start. It will also be noted that there is a very definite relation between the filament temperatures of the amplifying tubes and the position of the stabilizer arm. It will be found that, for the most sensitive condition of the amplifier a certain adjustment of the Master rheostat and stabilizer arm will give best results. These conditions also hold true when using the amplifier as part of the superheterodyne. When changing the phone plug to one or two stages of audio amplification, it will be necessary to re-regulate the Master and stabilizer again for the best results. It will be noticed that a fairly strong signal can be amplified to a signal of considerable volume, and then no further increase is obtainable; this is due to the fact that the tubes will only handle a certain amount of energy. However, with careful operation, an extremely weak signal can be built up to the same volume as the strong signal, due to the amount of potential amplification available in the amplifier.

The radio frequency amplification obtained through the use of these three stages of regenerative amplification is actually equal to tuned stages on account of the low frequency that is being amplified. Any attempt to Neutrodyne the stages will certainly result in a considerable loss in available amplification. It is believed that the true experimenter wishes to have an instrument capable of maximum sensitiveness and to have this, neutralizing devices must be left out.

Radiotrons UV201A and C301A have been found the most satisfactory for this Model C instrument, using a 6 volt storage battery supply and 90 to 108 volts B supply. Radiotrons UV199 or C299 can be used without any other changes than changing the A supply to four volts and the B supply to 80 or 90 volts; the volume obtainable is about 70 to 80% of that obtained with the A type tube. Radiotrons

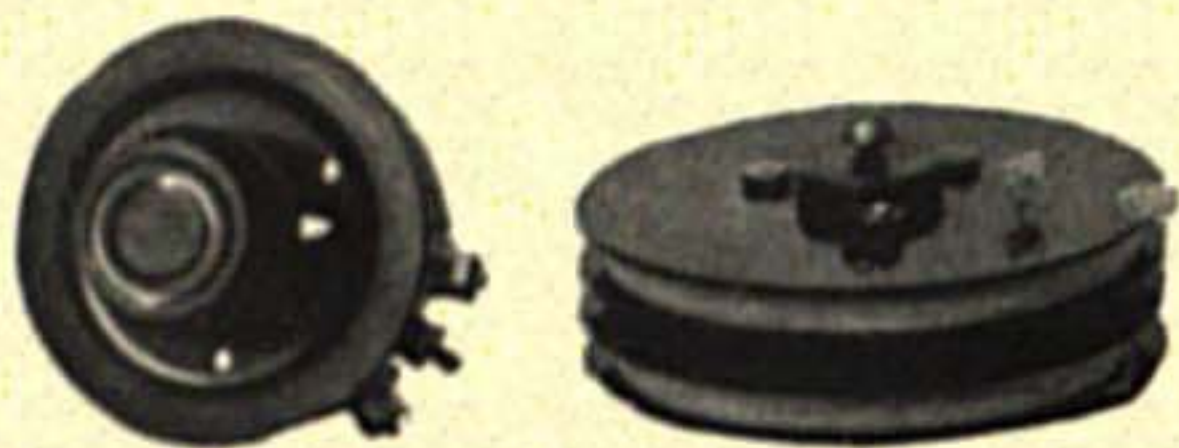

Fig. 36

General Radio
Potentiometer

Type "C"
R. F. Coupler

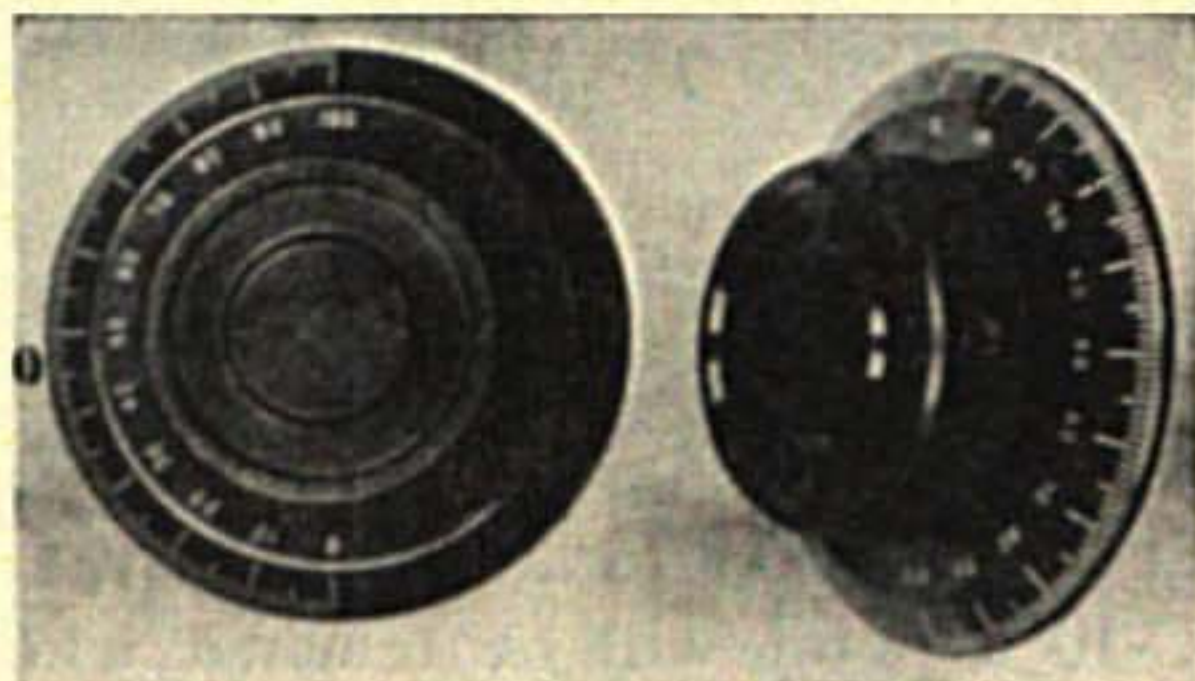

Fig. 37. "C 4" Dial and Knob.



Fig. 38. W.E. 21K Condenser and Eveready
751 Bias Battery.

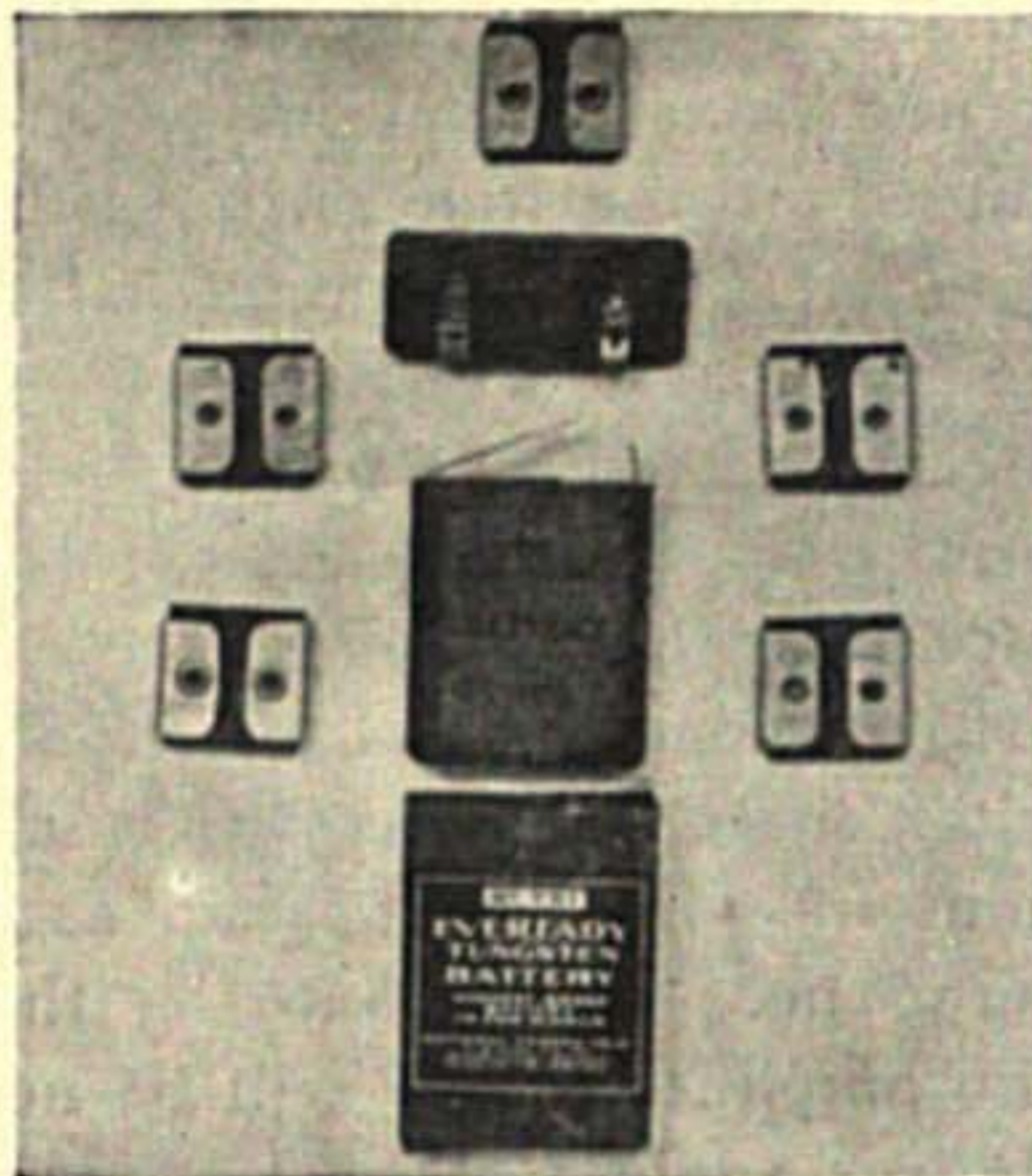

Fig. 39

Dubilier Type 601 and 600 Condensers.
Eveready Type 751 Bias Battery.

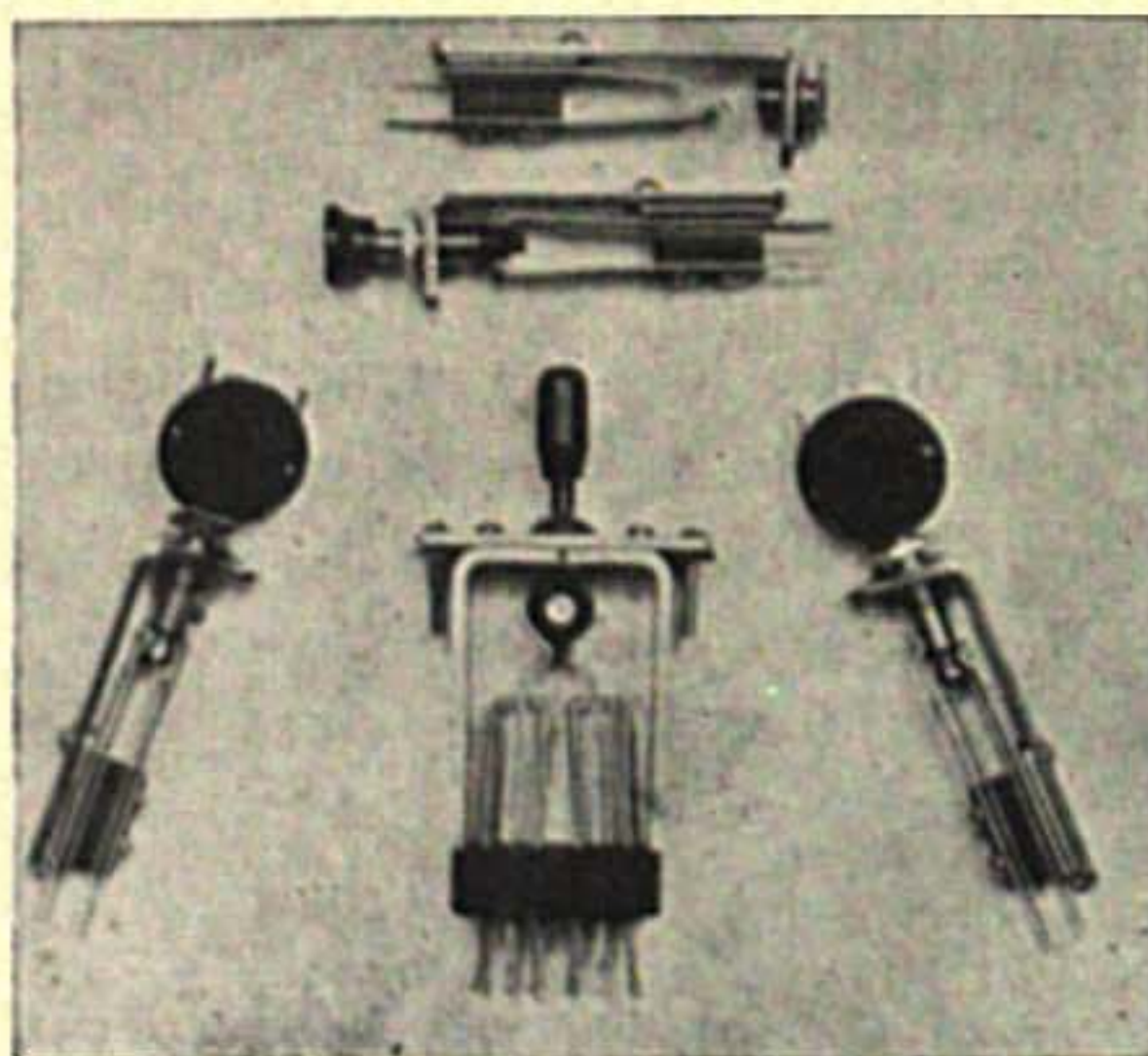

Fig. 40

Weston Plug, Premier Jacks, Jack Switch,
Federal Anti-Capacity Switch.

WD-12 can be used by changing the A supply voltage to $1\frac{1}{2}$ or 2 volts and the B supply to 80 volts. These last mentioned tubes are last choice, 201A tubes first choice and 199 type second choice, in each case the same type tube should be used throughout. During transit tubes are subject to severe shocks and jars and when the consumer receives a tube there is no assurance that it is perfect. When using a multiple tube receiver, always have two or three extra tubes and systematically substitute tube to determine if any are defective or even if some operate better than others.

There are several important points to remember during the construction of one of these Model C receivers. It is recommended that the necessary parts be purchased all at one place and preferably from a firm that can give assistance if it is required.

The inter-wiring should be of No. 12 B. & S. Gauge Copper Wire, preferably tinned. Each wire should be covered with a high grade empire cloth tube of the impregnated type, which has a puncture voltage on the order of 7,000 volts direct current. When soldering connections never use soldering acid, muriatic acid solution, Nokorode or any commercial fluxes. There is only one satisfactory flux for radio work and this is a solution of alcohol and rosin. To prepare same set about three ounces of powdered rosin in a small dish and cover with grain alcohol, leaving this over night. This will combine into a paste the consistency of which can be regulated by adding alcohol when required. When soldering with this flux a very clean and hot soldering iron is required and the joints to be soldered must be clean to the brass or copper and not nickel plated. Do not solder directly to sockets, transformer terminals, etc. Place a small copper lug on the terminal and solder to the lug.

Due to the distribution of wiring, it is possible to eliminate copper shielding in the Model C. For example, if while the set is in operation you touch your hand to the upper loop binding post, a squeal will be heard in the phones, while touching the lower post has no effect. The reason is due to the upper post running to the grid terminal which is at high potential. Accordingly, it is necessary to keep all grid wires and also all plate wires as far back from the panel as possible. Also keep the grid and plate wires spaced from each other as far as possible. The filament wires are not so important.

Likewise it will be noted that the low potential wires are specified to be run to the rotor plates of the variable condensers. This prevents body capacity at the adjusting dials completely.

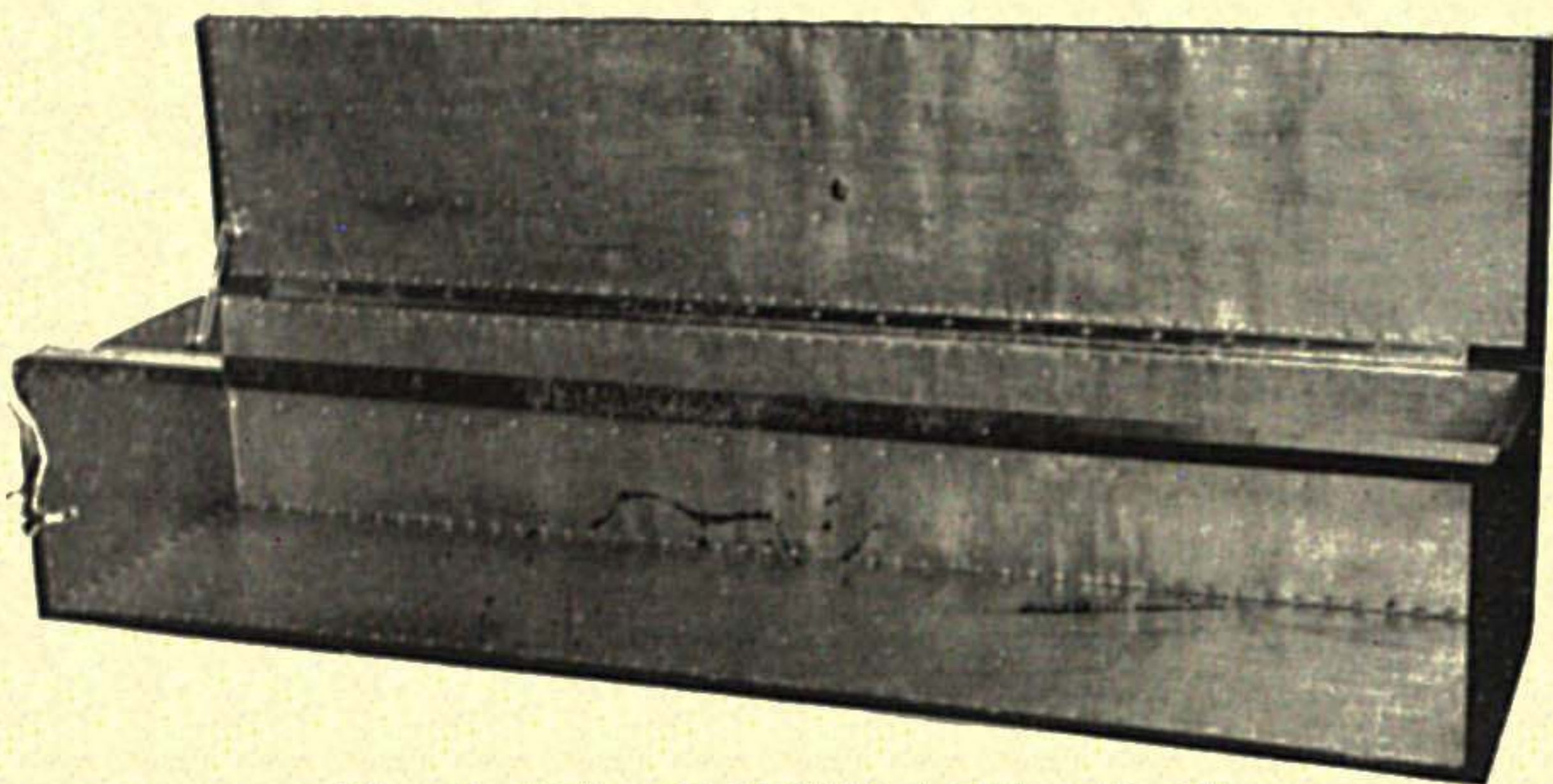

Fig. 41. "C" or "C-7" Shielded Cabinet, Special.

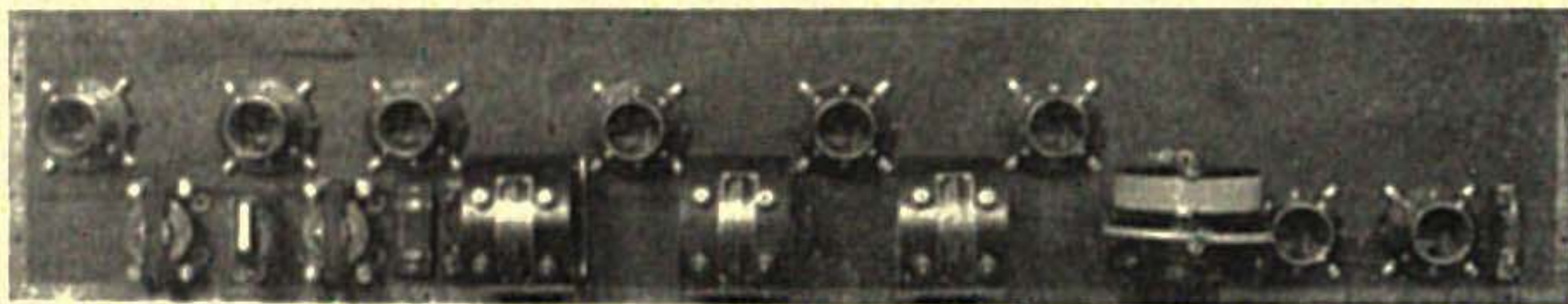

Fig. 42. Base Layout, Model "C."

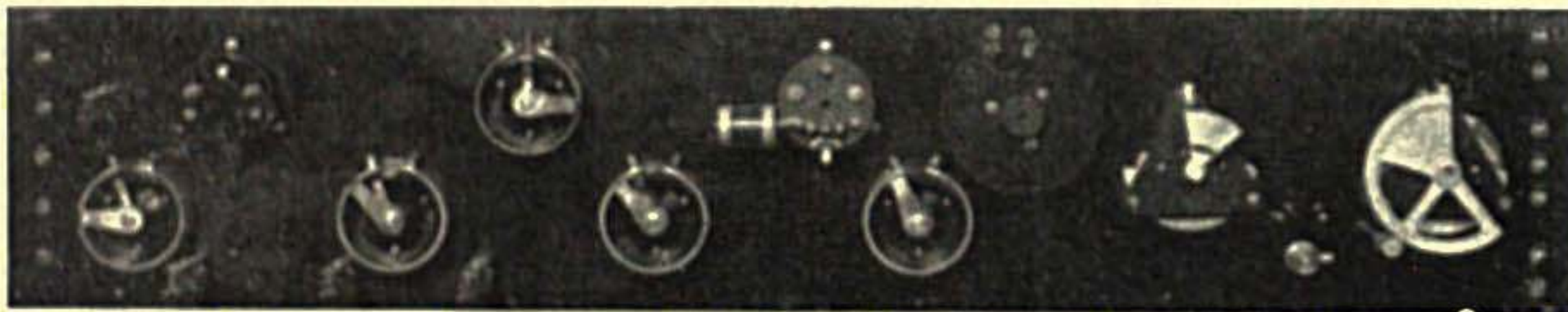

Fig. 43. Rear Panel Layout, Model "C."

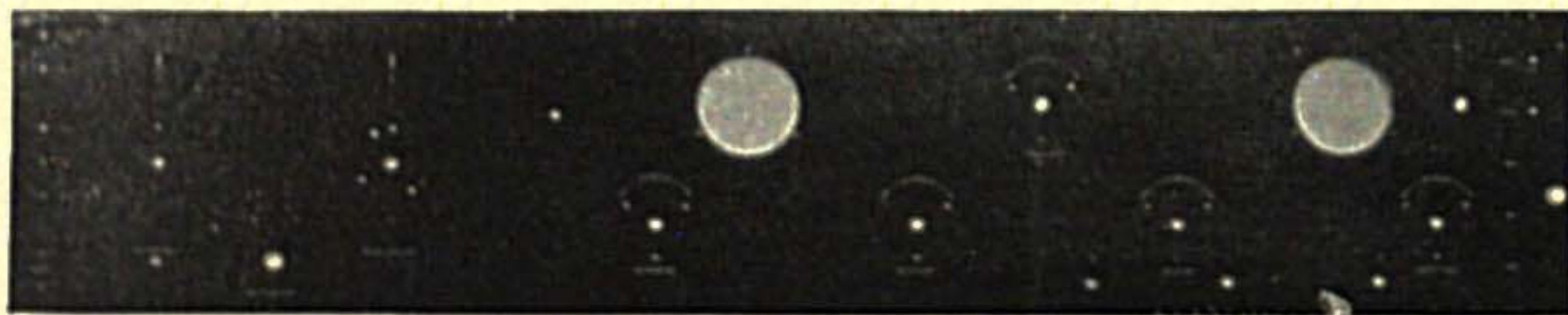
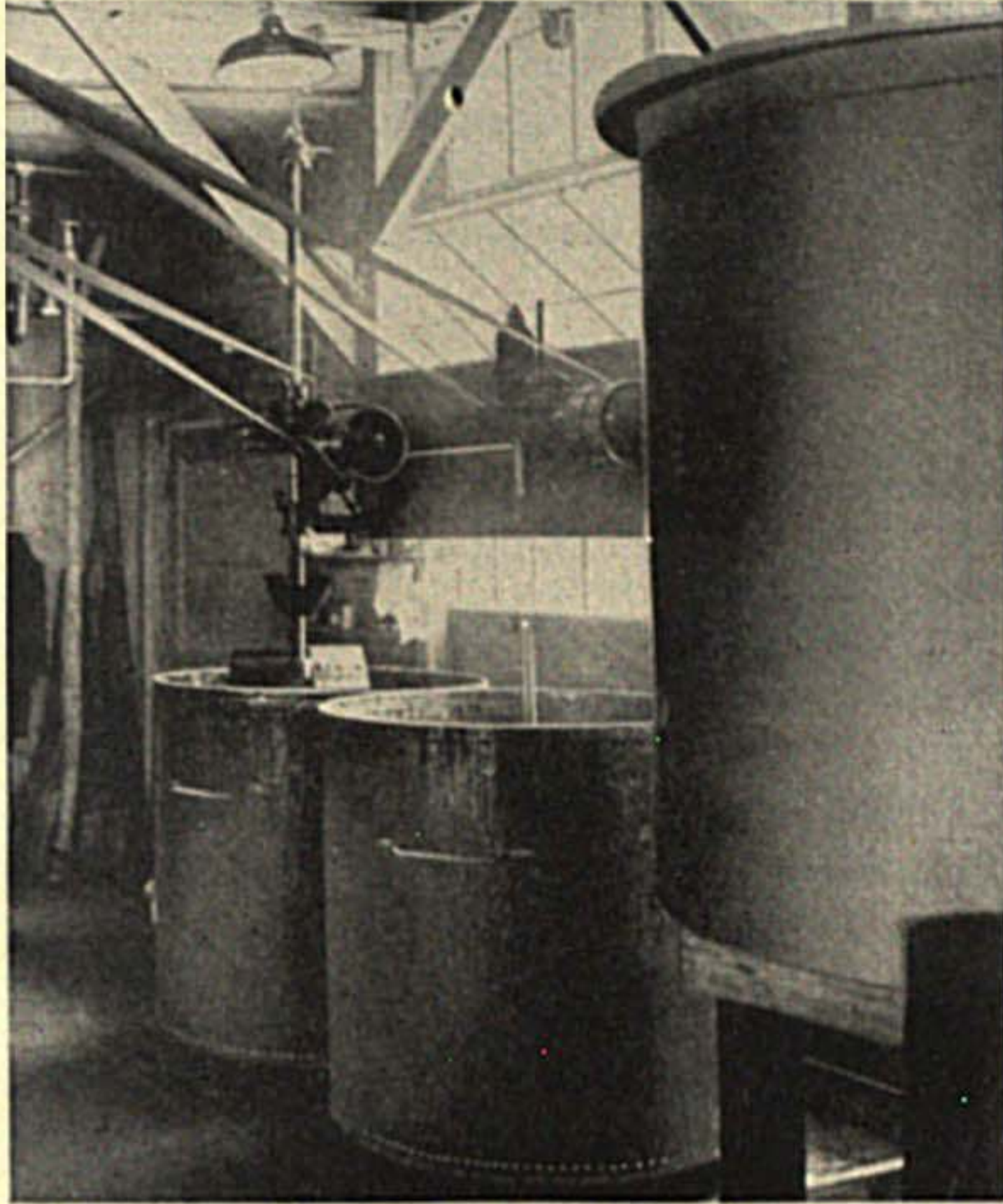

Fig. 44. Engraved Panel, Model "C."



Manufacturing Formica.

Mixing apparatus in which the Bakelite resins are prepared for the treating machines.

Around Jack J-1 a by-pass condenser of .005 M.F. is connected. This bypasses all radio frequency currents around the telephones or transformer primary as the case may be. When using the phones in this jack, it confines audio currents up to the phones only and prevents any coupling back to the dials, through the operator's body. To further insure against body capacity it is recommended that the telephones be equipped with Brandes shielded phone cords, the shield of these cords being connected to the negative A battery post.

In some cases this condenser does not bypass all the radio frequency component and this results in difficulties when trying to use the second audio stage. If this difficulty arises, it can be corrected by connecting another Dubilier Type 600 .005 M.F. condenser across the primary terminals of the second audio transformer. This will bypass any remaining radio frequency component and the capacity is not so high as to affect the reproduction quality.

It is well to test the jacks before assembling, to see that the springs make good contact when the plug is removed and that they open properly when the plug is inserted. It is also advisable to determine that none of the contacts are grounded to the jack frame. After mounting jacks on the panel, they should be adjusted to properly receive the type plug used.

Direct current voltmeters and ammeters have polarity and if they are not properly connected to the battery they will indicate backwards. Make sure that the positive side of the meter (indicated by a cross) is connected as shown in the diagram.

The wiring when finished should be checked by a different person than the one that did the wiring. It is never good practice for one to check his own work. It is well to connect a 40-watt Mazda lamp in series with the negative B battery at the battery terminal. This will prevent burning out the tube filaments in case the B Battery accidentally became connected to the A terminals.

The actual operation of a Super-Heterodyne receiver cannot be fully understood unless practice is combined with these instructions. It must be remembered that the operator cannot consider himself fully proficient with less than several weeks' experience. It is, however, possible to secure very good results after three or four weeks' practice. However, a thoroughly experienced operator can bring in signals to a high audibility that an inexperienced operator would not hear at all.

Briefly, it will be remembered that there are two tuning operations when using the C Model with a loop, 1, tuning the loop to the incoming signal; 2, adjusting the Heterodyne Oscillator to 30,000 cycles either side of resonance to the incoming signal frequency. The first operation is controlled by the "Wavelength" Dial and the second operation by the "Oscillator Heterodyne" Dial. There is a third operation which is of prime importance and that consists of adjusting the amplifier and other tubes for maximum sensitiveness, otherwise the tuning operations will not result in any response. Tuning operations are operations that effect the change in wavelengths. The operation of adjusting the amplifier for maximum response is not a tuning operation. The adjustment of the amplifier is an initial adjustment and only need be varied slightly when changing from one station to another, due to the varied signal strength and amount of amplification required for a fair signal. Suppose, for example, it is desired to receive the East Pittsburgh station KDKA. The first thing to do is to consult a daily program and confirm that the station is operating at that time. Much time has been lost trying to

receive stations that are not transmitting. The second consideration is the direction of the loop, which should be pointed in the general direction of East Pittsburgh, and guide yourself by a good compass. Do not bring the compass near the radio equipment or it will not read correctly. The leads to the loop should be short, not over four feet long and separated from each other one foot or more. Always have the loop to the left hand side of the Model C set.

Turn the Stabilizer to full left or counter-clockwise position. Insert phone plug in Det. jack and listen for a "click." If there is no click in the phones when putting the phone plug in and out the Det. jack, the detector battery line is open or shorted.

Now by consulting the graph in Fig. 23 we find that the Wavelength dial should be at 30 for 326 meters when using a loop and the graph in Fig. 24 indicates that 326 meters is obtained in that circuit by setting the Heterodyne dial at 41 or 36 with the wave change switch on S. Now, by setting these two dials at these points and increasing the Master rheostat and increasing the stabilizer, and then slightly readjusting the Heterodyne dial, KDKA should start to be heard, first maybe weak. If the Stabilizer or Master rheostat is increased too far, you hear a "plunk" or dull thud in the phones and the signal is then either lost or badly distorted. This action indicates that the radio frequency amplifier has started to oscillate which is very undesirable. This can be instantly stopped by decreasing the Master rheostat a full half turn quickly and then gradually coming up again until you reach a point just below the oscillation point. If the signal is not strong enough to hear comfortably, the phone plug can be plugged in the 1st Audio Jack. Here again, if the characteristic "click" is not heard, it indicates that the amplifier B battery lead is open. If the click is heard, but not the signal, it indicates that either the Detector jack is not closing properly, the transformer (1st Audio) is defective or 1st audio tube defective. Assuming that everything is all right, the signal will now be better and tuning easier.

In case the Heterodyne dial does not give any action as indicated in the phones, usually the trouble lies in too low a filament in the Oscillator tube, and this can be corrected by increasing the rheostat marked Heterodyne. Otherwise, the tube is a poor oscillator and a better tube should be substituted. The phones or loud speaker can now be plugged in the 2nd Audio jack if desired. If the initial detector signal is loud, it will be difficult to use both stages of audio without reducing slightly on the Master rheostat and Stabilizer, otherwise distortion will result as tubes are only capable of handling a certain amount of energy.

SPECIAL JEWELL FIVE POINT VOLTMETER.
VIEW LOOKING AT THE REAR.

POS.	READING
D	1ST DETECTOR VOLTAGE
H	OSCILLATOR VOLTAGE
M	RAD AND AUDIO FREQ VOLTS
R	2ND DETECTOR VOLTAGE
B	"B" BATTERY VOLTAGE

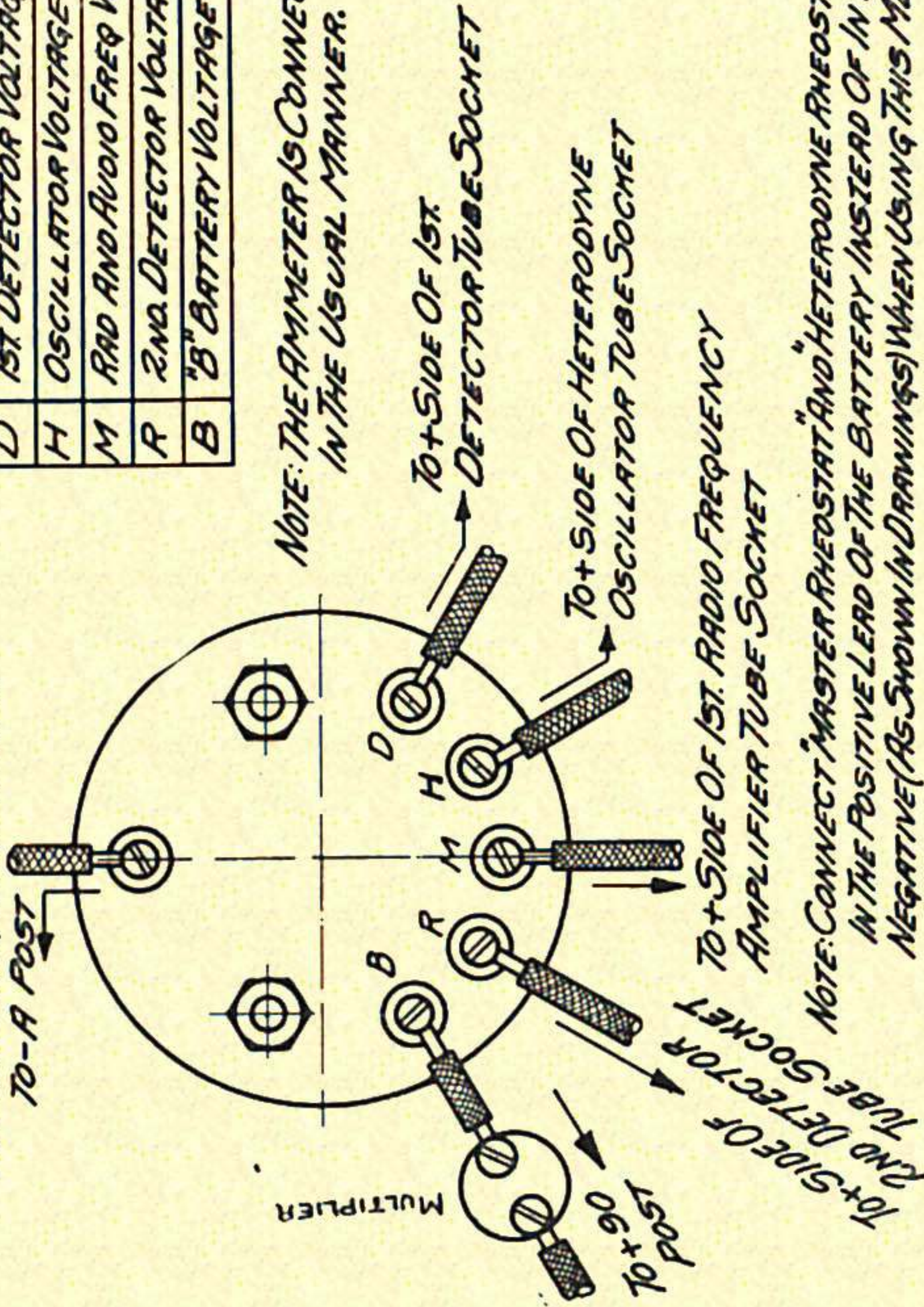

NOTE: THE AMMETER IS CONNECTED IN THE USUAL MANNER.

NOTE: CONNECT "MASTER RHEOSTAT AND HETERODYNE RHEOSTAT" IN THE POSITIVE LEAD OF THE BATTERY INSTEAD OF IN THE NEGATIVE (AS SHOWN IN DRAWINGS) WHEN USING THIS METER.

Fig. 45

Connections for Special Model "C" - Jewell Voltmeter

*SCHEMATIC WIRING DIAGRAM
RADIO RECEIVER - WESTERN ELECTRIC TYPE
SIMILAR TO THE SUPER HETERODYNE.*

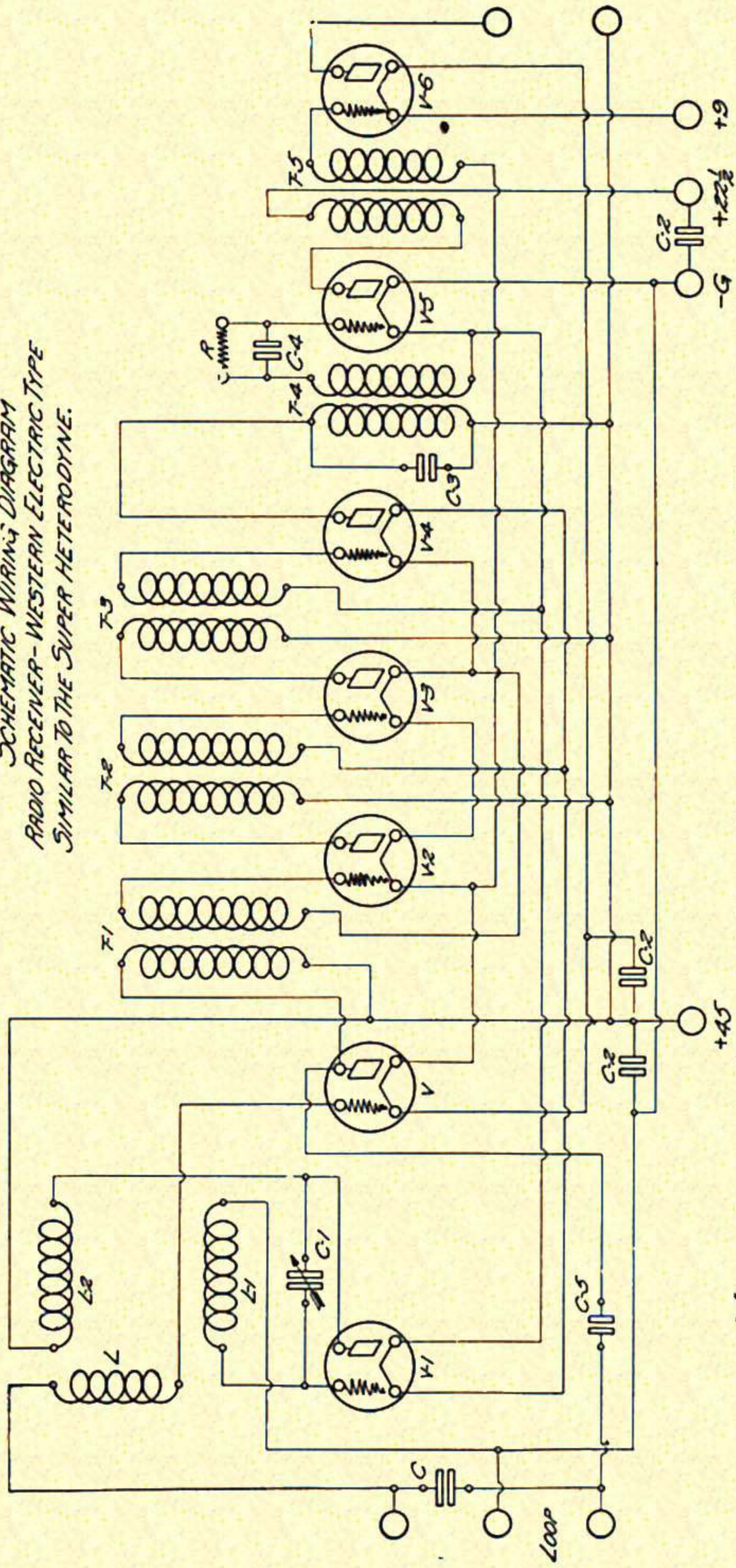

N TYPES ARE USED, ALL CONNECTED IN SERIES. THE POTENTIAL DROP ALONG THE FILAMENT LINE UTILIZED FOR THE NECESSARY BIAS VOLTAGES FOR DIFFERENT TUBES.

- C* LOOP TUNING, WAVELENGTH CONDENSER
- C-1* OSCILLATOR, HETERODYNE CONDENSER
- C-2* BY-PASS CONDENSER
- C-3* TRANSFORMER CONDENSER
- C-4* GRID CONDENSER
- T1, T2, T3* AND FREQ. TRANSFORMERS
- T-4* TUNED OUTPUT TRANSFORMER
- T-5* AUDIO FREQ. TRANSFORMER
- R* GRID LEAK
- L1, L2* OSCILLATOR COUPLER

Fig. 46

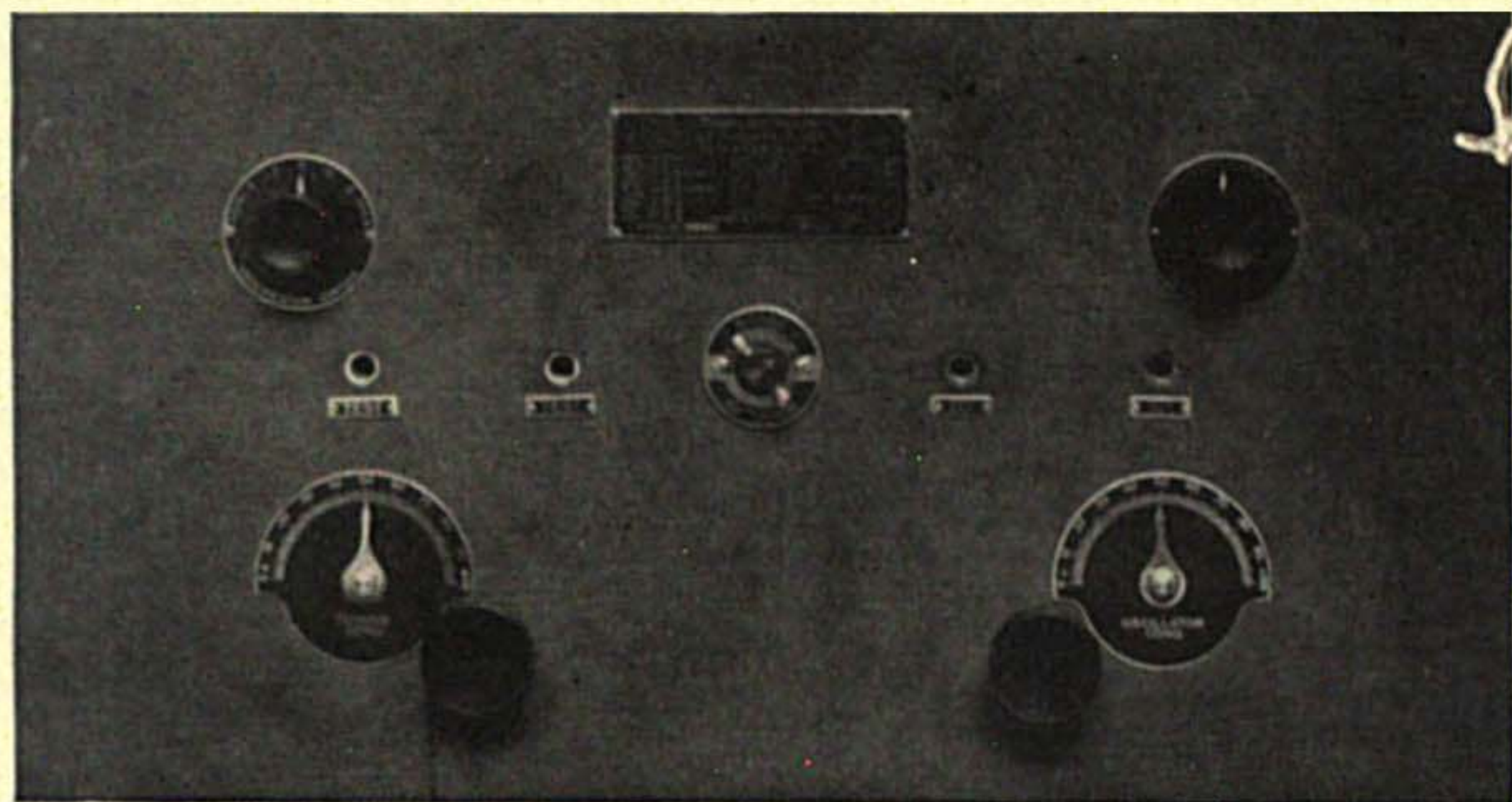

Fig. 48

Western Electric Type 4B, Super-Heterodyne. This receiver is designed for the "N" Peanut Tube. There is a total of 6 tubes, the filaments of all are in series. The use of these small tubes provides the advantage of portability, but the small tubes will not supply the volume obtainable from the larger tubes. There are only two variable units, the variable Heterodyne Condenser and the variable Wavelength Condenser to tune the loop. The Northern Electric Co., which concern controls the Western Electric Patents in Canada also manufactures a 4-B Receiver. The Northern Electric Set is equipped for both Antenna and Loop Reception, while the Western Electric Set is only arranged for Loop Reception. However, any Loop Receiver can be adapted for antenna reception as shown later on in this book.

The volume control in this design consists of a variable resistance adjustable in steps, connected across the primary of the first intermediate radio frequency transformer. A decrease in the total resistance used decreases the signal strength without destroying the reproduction qualities. A Rheostat is provided to regulate the total filament voltage. A switch is provided to disconnect the stage of audio amplification.

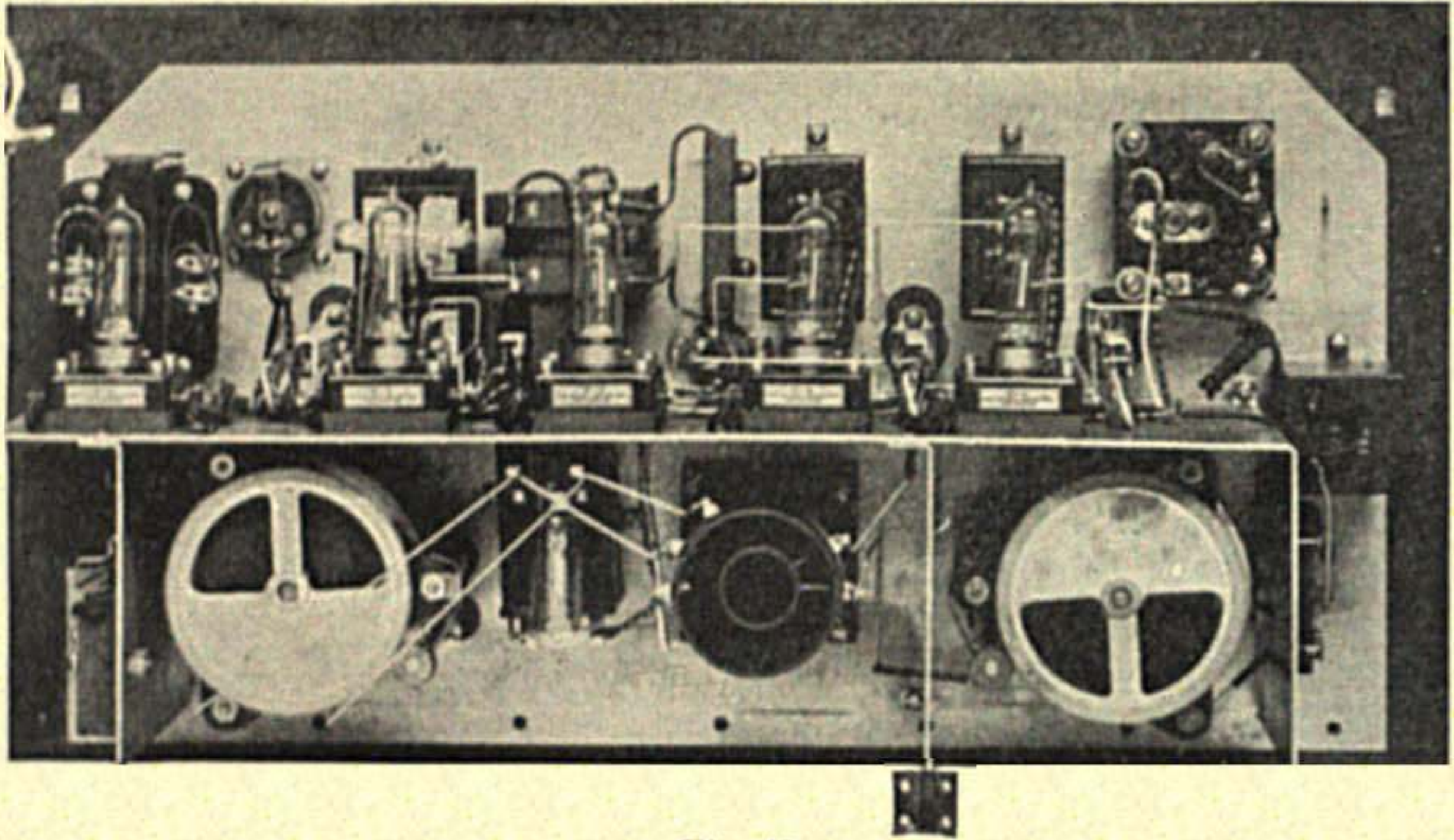
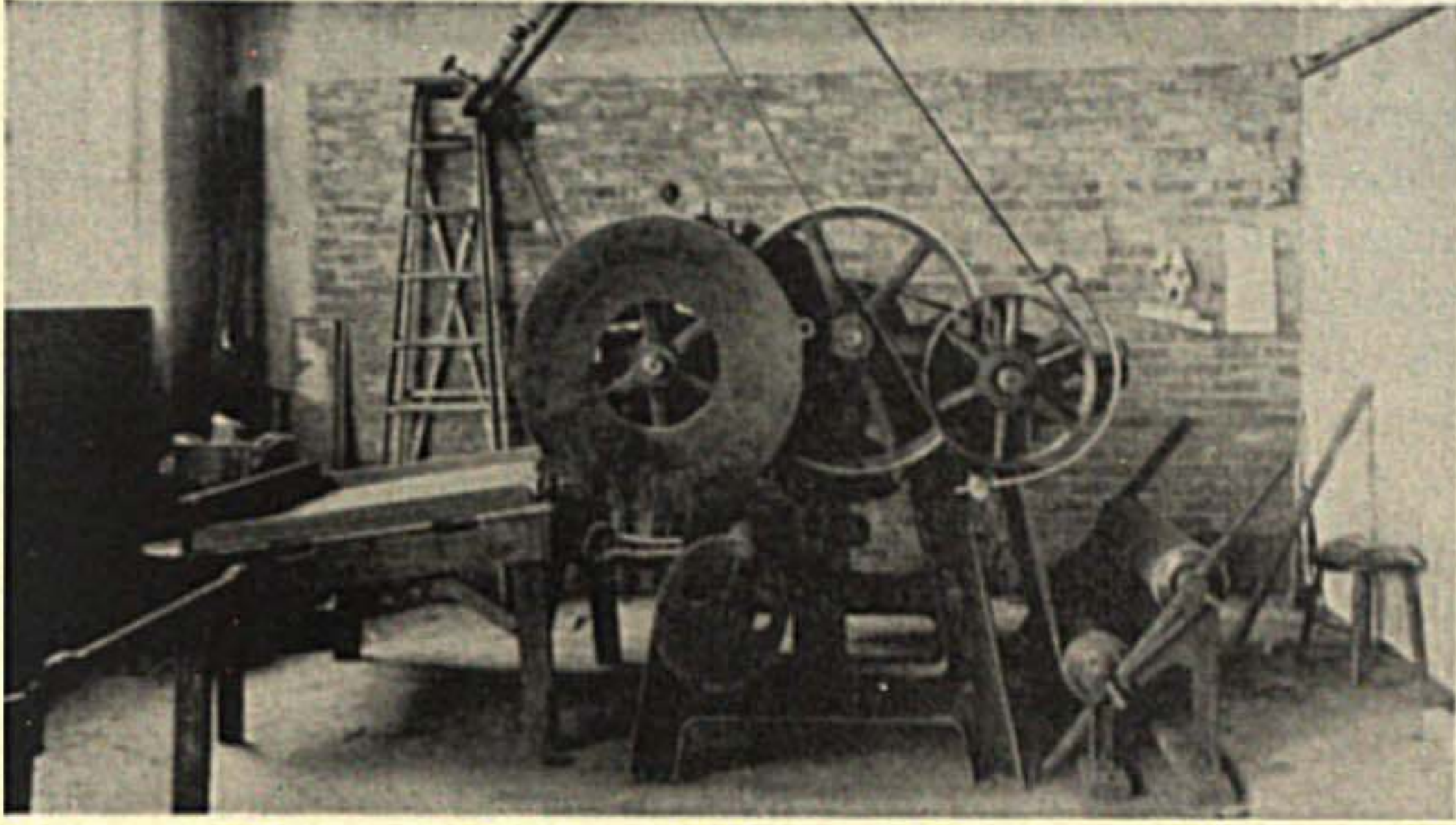

Fig. 49

Rear view of the Western Electric 4-B Super-Heterodyne. The front panel is shielded and there are shielded compartments shielding the amplifier from the oscillator and separating the oscillator from the loop tuning condenser. The volume control resistors are located in the upper right hand corner. The loop tuning condenser in the right hand lower corner and Heterodyne Oscillator Condenser in the lower left hand corner. The oscillator tube and Oscillator Coupler are in the center of the lower section. The main by-pass condenser is directly in back of the oscillator tube. The output transformer is directly in back of the center tube (2nd R.F. Amplifier) in the upper section. The fixed condenser tuning the primary of this transformer is directly to the right of the transformer. The intermediate radio frequency transformers are located behind the first two tubes to the right in the upper section. The audio transformer is located behind the last tube left, upper section. The loop and battery connections are all made from the rear. The small twisted wire shown under the volume control resistor in the upper section right, is the compensating condenser.



Manufacturing Formica.

A cutter in which rolls of Bakelite treated paper are cut to size.

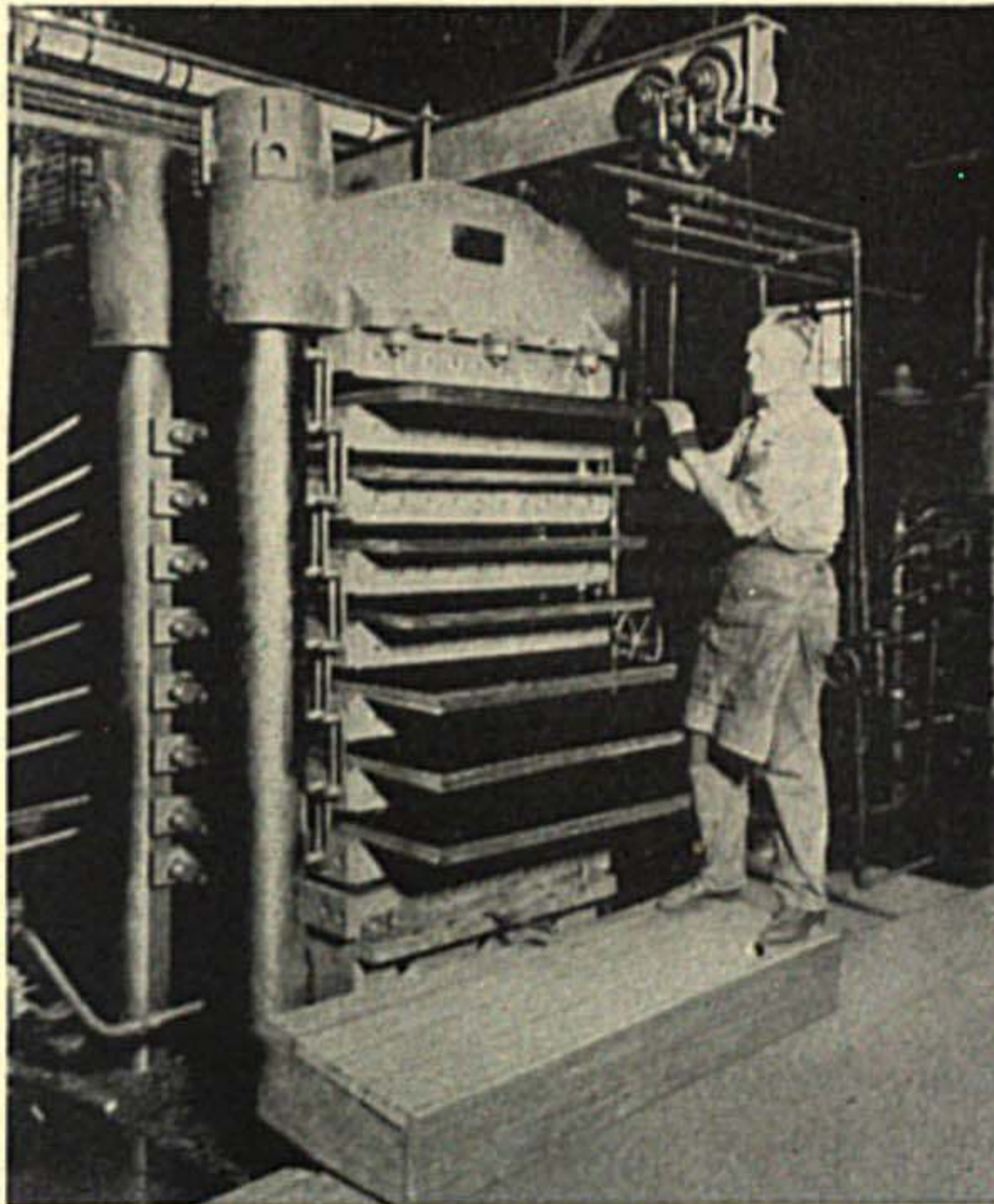

Manufacturing Formica.

A Press in which the Bakelite treated sheets are fused by heat and pressure into Formica.

For experimental purposes the loop can now be revolved to determine the direction from which maximum energy is obtained from that particular station. It is not unusual to find that maximum signal strength is obtained by pointing the loop in an entirely different direction than what a compass and map would lead you to select. This is due to the propagated waves being deflected in their course due to obstacles such as ore deposits, woodlands, steel structures, etc. Loops used within stucco houses have very poor directional qualities due to the wire mesh which entirely shields the house in this type of construction. In this case it has been found that the greatest signal strength is obtained with the loop near a window or windows.

Regulating the filament temperature of the oscillator tube through the rheostat Heterodyne, varies the oscillator radio frequency current over a considerable scale, on some adjustments from 20 to 150 milliamperes. The energy received from the transmitting station is considerably less than this, from a fair signal, only a fraction of a milliamperc. The relation between the strength of the local oscillations and incoming oscillations has considerable bearing on the resulting signal. It will be found that the local oscillations will have to be quite strong and this can be regulated very nicely with the filament temperature. This could be further regulated by varying the inductive coupling between L-1 and L-2 by an adjustment, but this is not necessary.

Ordinarily a UV200 Tube, properly adjusted for plate and filament voltages will give much more sensitive detection than a UV201A tube, and this is true in an ordinary regenerative receiver. However, in a super-heterodyne, the detector gives heterodyne amplification and has heavy currents flowing through it and a UV200 detector tube cannot be used to give any decided advantage over a selected UV201A tube used as a detector.

Furthermore, in an ordinary detector circuit, tuning the plate circuit or providing grid plate coupling will produce regenerative amplification equal to 1 or 2 stages of audio frequency amplification. The amount of regenerative amplification obtainable depends largely upon the skill of the operator. However, the 1st detector tube in a super-heterodyne is already working to nearly its full capacity and efforts to secure regenerative amplification here in addition are not meeting with any great success. By weakening the coupling between L-1 and L-2 regenerative amplification can then be used. However, the weakening of coupling between these two points weakens the signal and the regenerative amplification obtained must compensate for this loss before making a gain. For general work it will be found that the gain from regenerative



Fig. 51

Front View Standard Model C-7 Super-Heterodyne. Only two dials, one for the Heterodyne Oscillator and one for tuning the detector circuit. Verniers provided for each of these dials. Rheostats provided to control volume intensity and to control filament voltage. Compensating Condenser provided to control regenerative amplification in first detector.

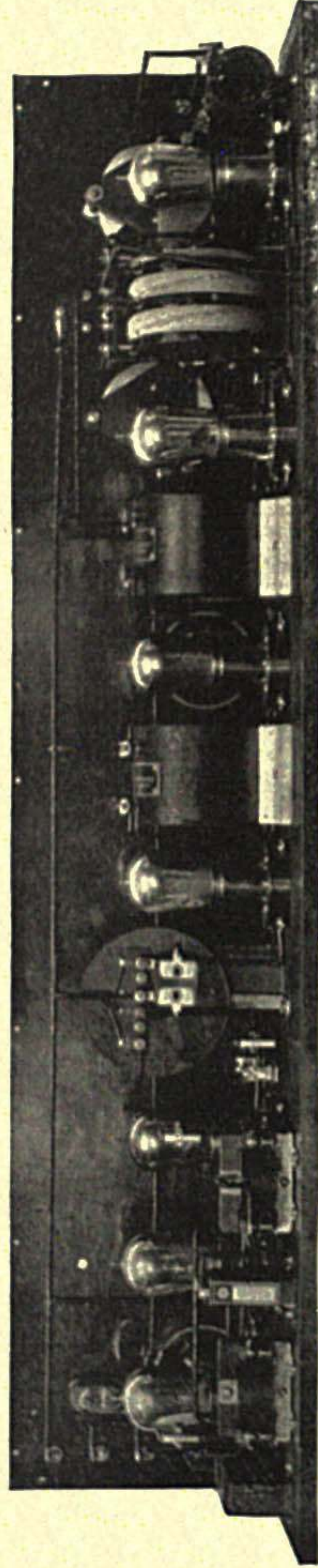

Fig. 52

Rear View, Standard C-7 Super-Heterodyne. Front, right to left, following component parts show, Antenna Inductance, Oscillator Tube, Oscillator, Oscillator Coupler, Wavelength Condenser, Detector Tube, R. F. Transformer, R. F. Tube, R. F. Transformer, R. F. Tube, Output Transformer, Detector Tube, Audio Transformers and Audio Tubes.

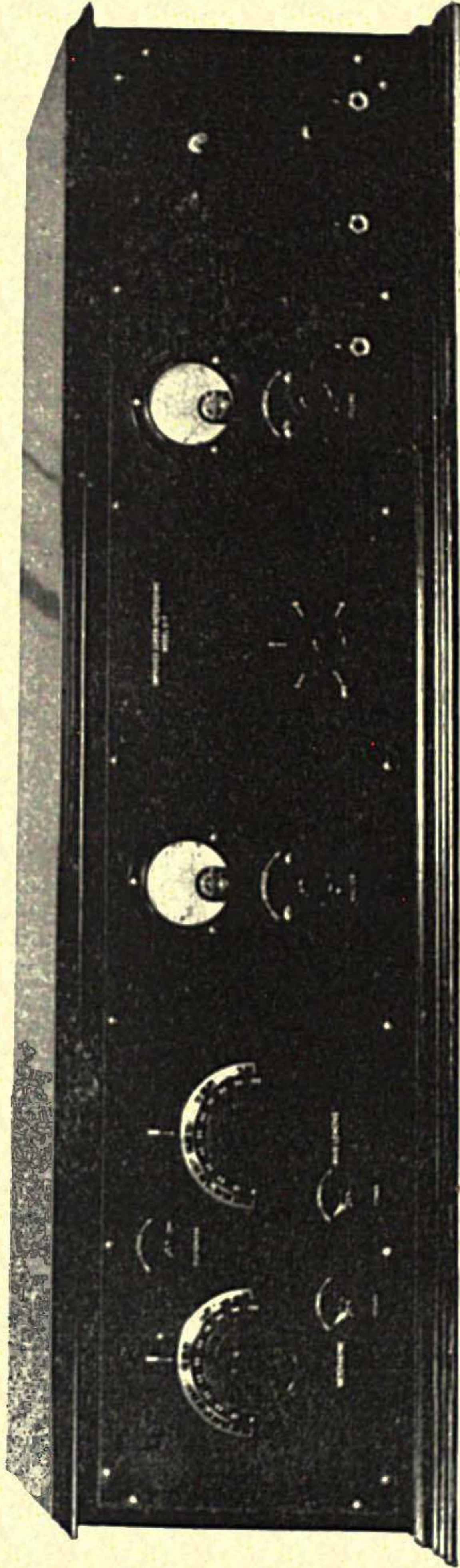

Fig. 53

Front View, Special C-7, Panel arrangement differs from standard set. Jacks are provided to use two, one or no stages of audio amplification. Pair of Special Weston Meters is specified. One meter reads battery supply voltage, detector voltage, amplifier filament voltage, and B Battery voltage. Other meter reads total current consumed. A switch is provided for the two scale voltmeter. Special Cabinet is used.

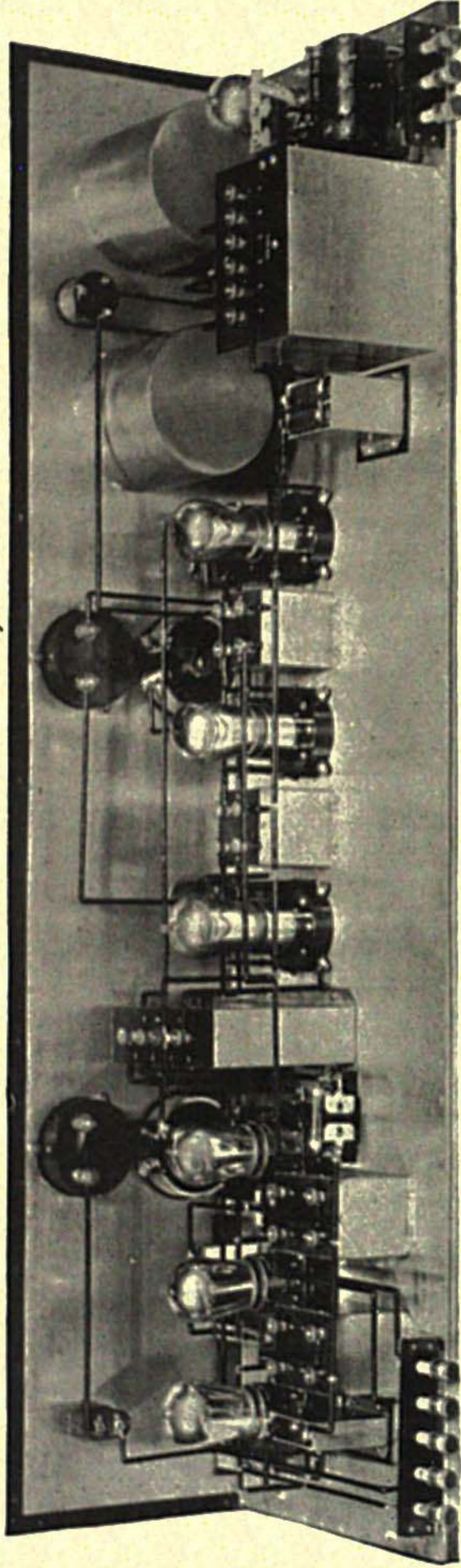

Fig. 54

Rear View, Special C-7. Note that all important component parts are individually shielded, such as, Variable Condenser, Oscillator Coupler, R. F. Transformers, Audio Transformers, Output Transformer. The entire inside surfaces of the cabinet and the inside surface of the panel are also shielded.

amplification at this point will not warrant the extra equipment and control, and is not desirable.

Suppose, now, we wish to change from the East Pittsburgh station to the Springfield station WBZ, operating on a wavelength of 337 meters which is slightly higher than Pittsburgh's wave.

It is obvious that, inasmuch as Springfield's wavelength is greater than that of Pittsburgh, that this higher wavelength of 337 meters will be found further up on the Wavelength and Heterodyne dial adjustments. This assumption is quite true and the exact amount of increase for the Wavelength dial can be found on graph Fig. 23 and for Heterodyne Dial on graph Fig. 24.

However, for Kansas City, on a wavelength of 546 meters, it requires more than dial adjustments. It will be noted on the graphs that, to tune the Heterodyne Dial to 546 meters, the wave-change switch must be on the L position, and to tune the Wavelength dial to 546 meters that the extra 6 turns on the loop must now be connected in. The exact locations for this wavelength and all other broadcasting wavelengths are shown on these two graphs and, while they will not be accurate for every individual case, they will give a very close approximation to be guided by.

It will be noted that, if the amplifier stabilizer control is increased too far, the amplifier will oscillate, and when varying the Heterodyne dial during this condition a series of whistles will be heard every one or two divisions on the dial. These whistles are "beats" between the amplifier oscillations and local oscillations, and as this condition is undesirable, the amplifier should always be prevented from oscillating. Even when the amplifier is not oscillating, beats will be heard due to the local oscillator and the oscillations picked up from improperly adjusted receivers in the neighborhood. However, as there are two points on the Heterodyne dial to select from, usually one of these points will tune in the desired signal without any "beat" disturbance.

In the event that it is desired to pick up a weak signal by the "carrier wave" method, the amplifier can be adjusted for oscillations and the desired "beat" tuned to in a similar manner that is employed for continuous wave tuning.

After a receiver of this type has been in commission for some time, attempts should be made to secure a better tube selection. A substitute tube should be tried in each of the different sockets, and after inserting this substitute tube always readjust the rheostats and

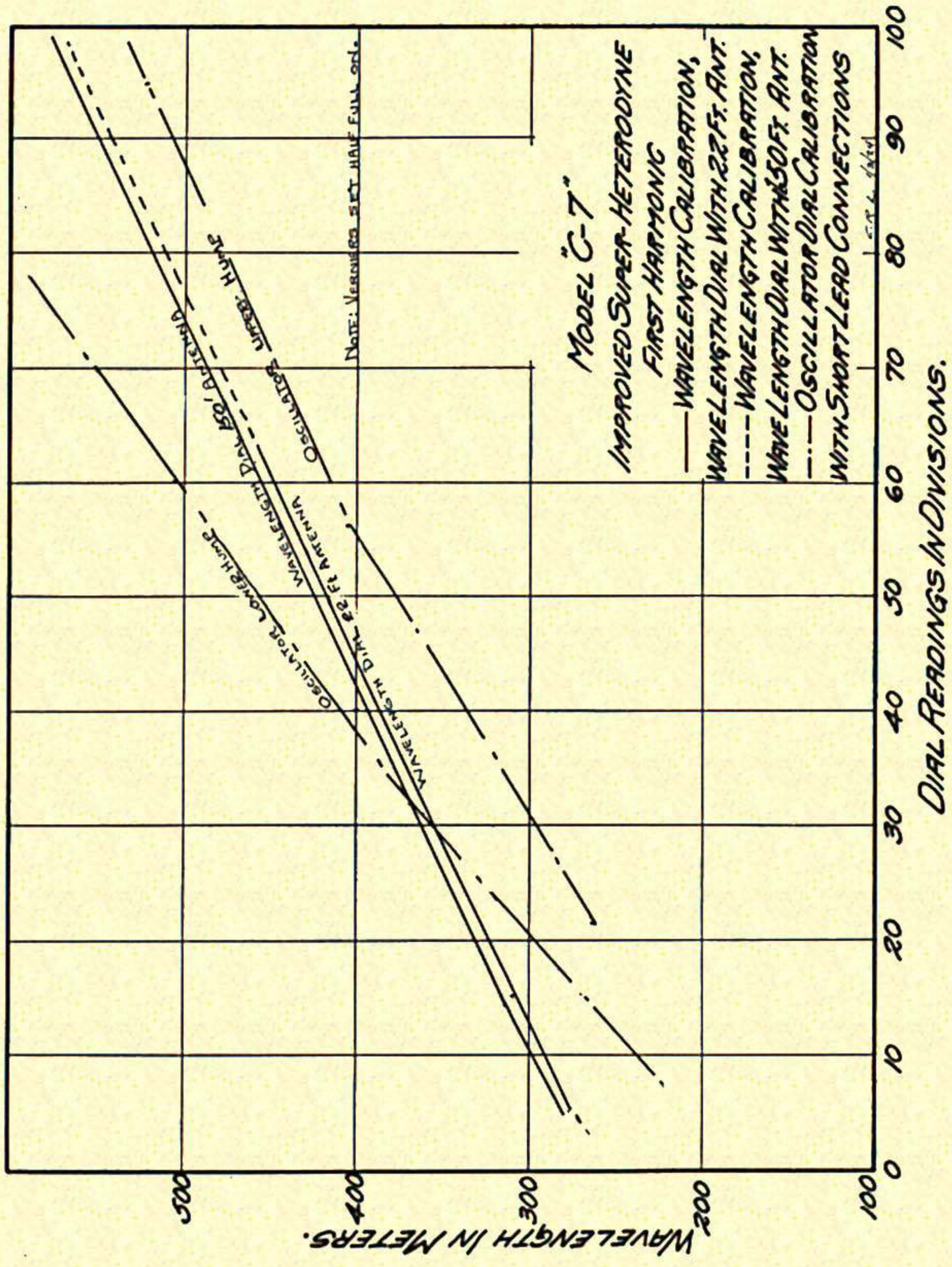

Fig. 55

tuning controls. Tubes have different characteristics and require individual adjustments. When changing detector tubes it is always well to try different detector voltages from 22 to 45 volts on UV201A and UV199 tubes. If the tubes have previously been selected by an expert they should be left alone unless results indicate that one of the tubes has turned defective.

The A and B battery voltages should be kept up to the specified voltages. An eight tube receiver of this type draws 30 to 50 milliamperes at 90 volts which is about three times the normal discharge rate of ordinary dry B batteries. In view of this, the life of ordinary dry B batteries is greatly reduced and storage B batteries should be used where economy is a factor. The B battery voltage should always be measured with the set in operation and always with a reliable high resistance voltmeter. Cheap voltmeters draw from 30 to 100 milliamperes at 90 volts which adds to the B battery load and gives a misleading reading. Likewise, when measuring the filament voltage of a tube at the filament terminals, the meter current will add to the filament current and the resultant drop due to the rheostat will be a combination of both currents resulting in a reading that is subject to considerable correction. This is particularly true when measuring low current tube filament voltages.

When using this type receiver to actuate a Western Electric Type 10A Loud Speaker and Power Amplifier certain precautions must be observed. It is suggested that the Western Electric Amplifier Unit be placed directly to the right of the C Model. The A and B Battery leads should be preferably No. 14 B. & S. Rubber Insulated, Lead covered wire. The lead coverings of all the leads should be connected together and also connected to the Negative A binding post on the C model.

It will be found that plugging the input of the amplifier into the Detector jack on the C model will give sufficient volume for all ordinary sized rooms. If greater volume is desired, one stage of audio can be used and in some instances it might be necessary to use the two stages of audio in the C Model. In this latter case it would mean 4 stages of audio frequency amplification and this is not considered practical. However, with the above precautions observed it is quite possible to use the four stages. The use of four stages is greatly simplified by using separate A and B battery supplies for the Western Electric Amplifier. In any event, always use a separate B battery for the Western Electric Amplifier and, if desired, a common storage A Battery can be used for the Model C and W. E. Amplifier.

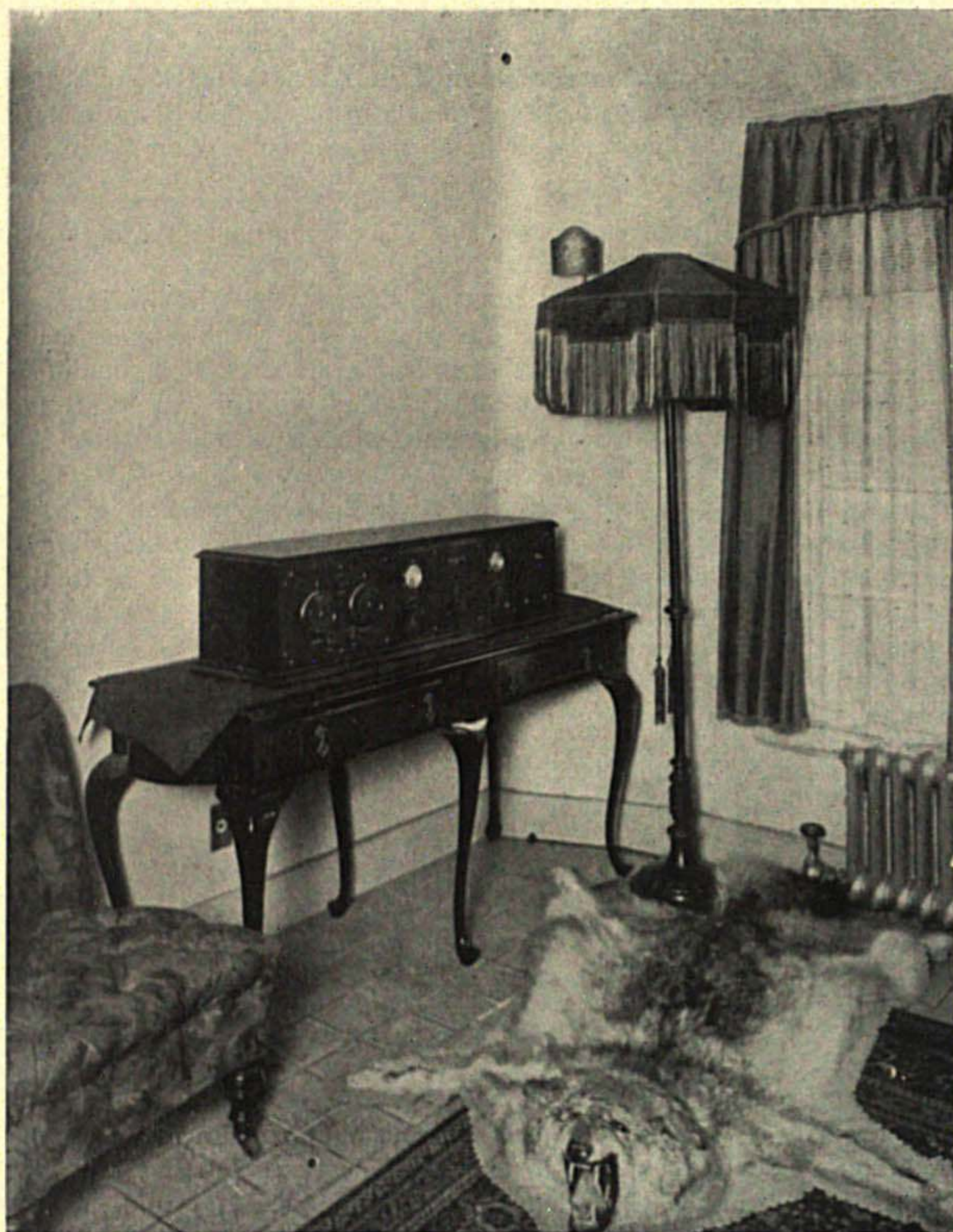
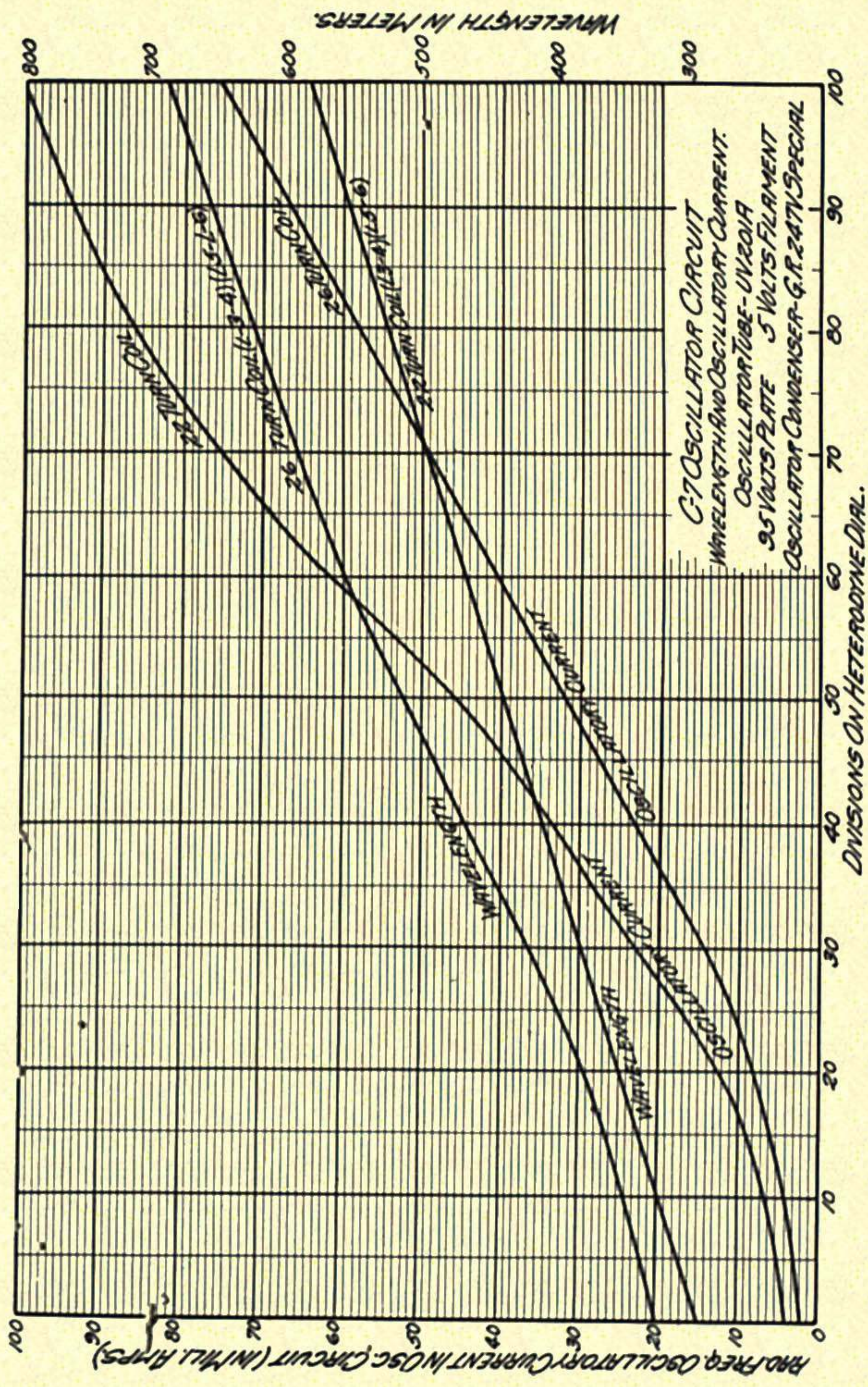

Fig. 56

Special C-7 installation in the home of the writer. Batteries are located in the basement. Loud speaker output runs to a switchboard where it can be distributed to any number of rooms each of which is equipped with a Loud Speaker.



C-7 OSCILLATOR CIRCUIT
 WAVELENGTH AND OSCILLATORY CURRENT.
 OSCILLATOR TUBE - UN201A
 9.5 VOLTS PLATE 5 VOLTS FILAMENT
 OSCILLATOR CONDENSER - G.R. 247V SPECIAL

Fig. 57
 DIVISIONS ON HETERODYNE DIAL.

Fig. 25 shows the method of making external accessory connection to the Model C Receiver. Fig. 26 illustrates a Model C and Model J Units installed jointly, it is noted that the Model C is equipped with two extra meters, one is a 0-100 DC Milliammeter to read the total plate battery consumption and the other is a 0-100 DC Voltmeter to read the plate battery potential.

Fig. 27 is a standard Model C Super-Heterodyne equipped for Loop reception. Fig. 28 is a Model C installed with a Model K Antenna Adapter. This Model C is also equipped with the two extra meters. A Western Electric 10-A Horn and Power Amplifier is included.

The importance of selecting high quality parts for the construction of radio receivers cannot be too strongly suggested. Fig. 29 is a standard Model C Oscillator Coupler. When used with a .001 Type 239 Condenser the lower wavelength range is about 200 to 500 meters and the upper range 350 to 900 meters. The lower range is obtained by connecting the condenser across the grid coil alone and the upper range by connecting the condenser across both the grid and plate coils jointly. When used with a .0005 MF Type 247V Condenser its wavelength range is about from 150 to 400 on the grid coil alone and about 275 to 620 on the upper range using Grid and Plate coils together. Fig. 30 is a pair of Special Jewell Meters for the Super-Heterodyne Receiver. The Voltmeter is provided with a five-point switch, accordingly it can be used to measure the voltage at five different points in the receiver. The meter has two scales, one for measuring voltages in the vicinity of 6 and the other for measuring voltages in the vicinity of 100. There is nothing special about the ammeter other than it is made to match the voltmeter.

Fig. 31 is a Type C Radio Frequency Amplifying Transformer. This transformer was designed to operate most efficiently at 47,000 cycles. The amplification factor is probably higher than any other long wave amplifying transformer available. The amplification band has a broad peak, purposely, as it is decidedly better to have the filter action in the form of a tuned input or tuned output, rather than have all the intermediate transformers tuned. A little over a year ago there were only two intermediate amplifying transformers available, the UV1716 made by the General Electric Co., and the Type C made for the Experimenters Information Service, at that time. Since then many manufacturers have placed upon the market different designs of different quality and performance. A large number of these various models are very inefficient. The type C is particularly recommended as it is designed as being particularly adapted to the Model C and Model C7 Super-Heterodynes. Fig. 32 is the General Radio Type 231A Audio Transformer. This is a 3 to 1 ratio

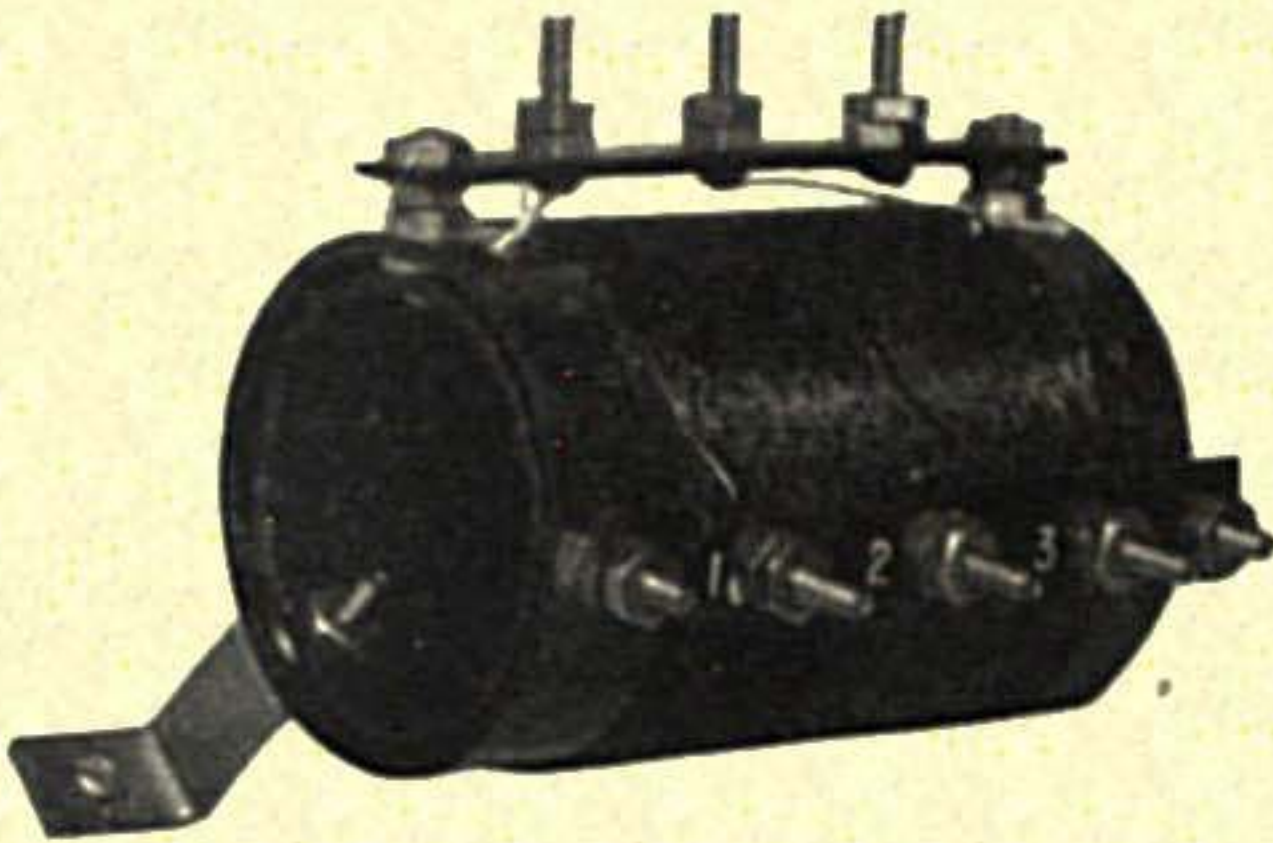

Fig. 58. Type C-7 Antenna Inductance.



Fig. 59

Type C-7. Oscillator Coupler.

The new type Oscillator Coupler and Antenna Inductance are supplied in several sizes and with interchangeable plugs and sockets, to cover all wavelength ranges.

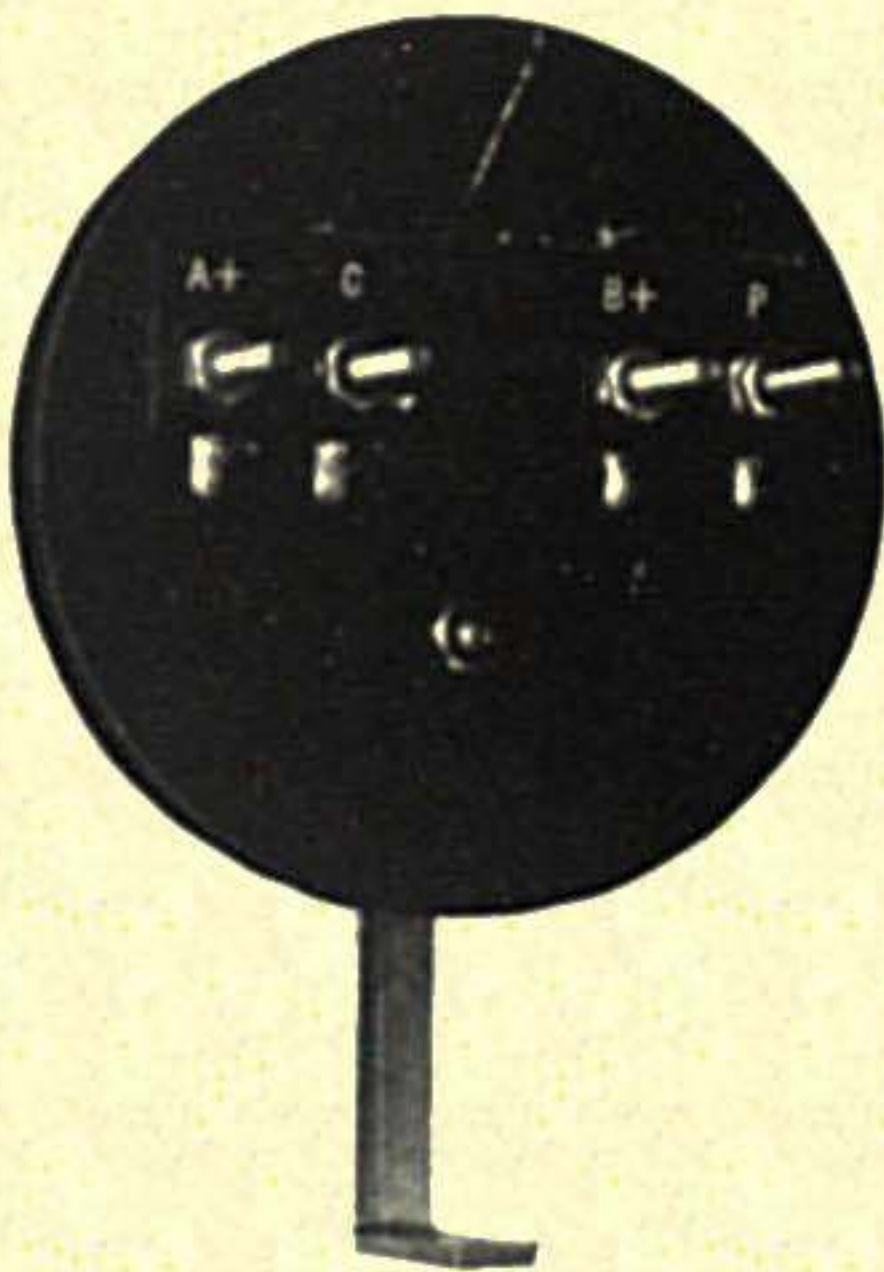

Fig. 60. Type C-7 Output Coupler.

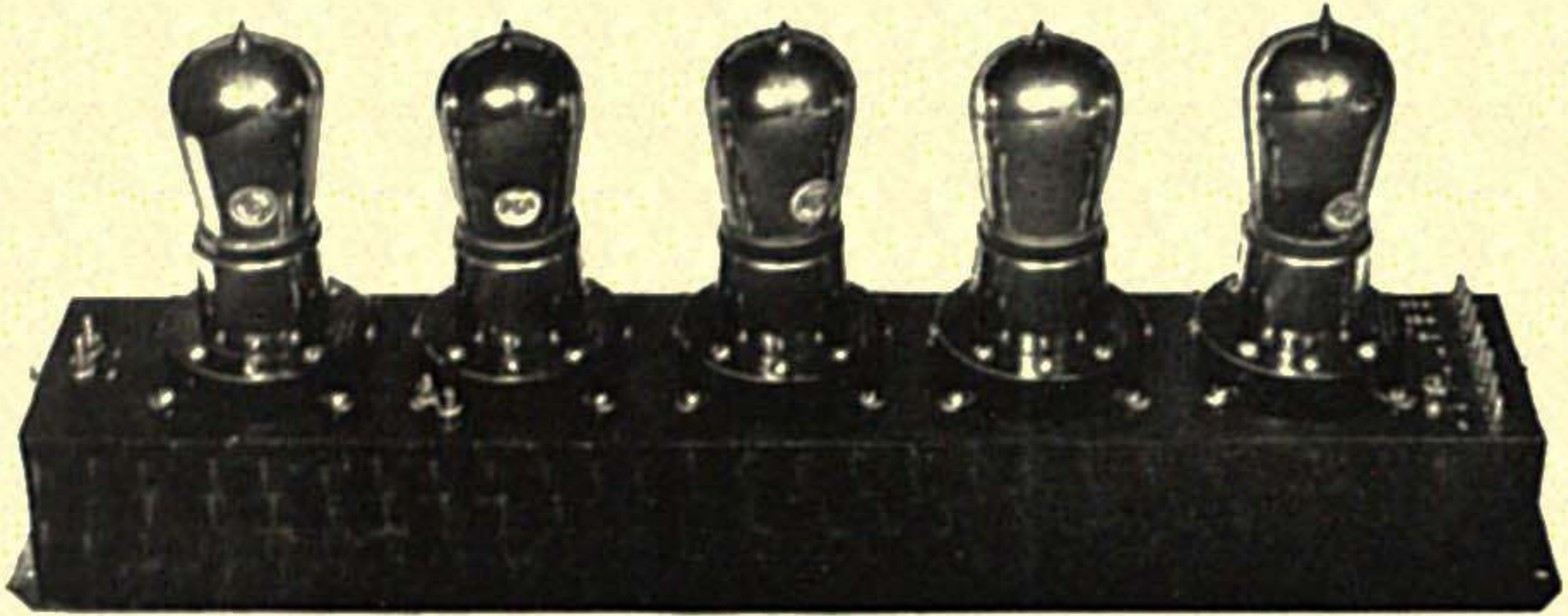

Fig. 61

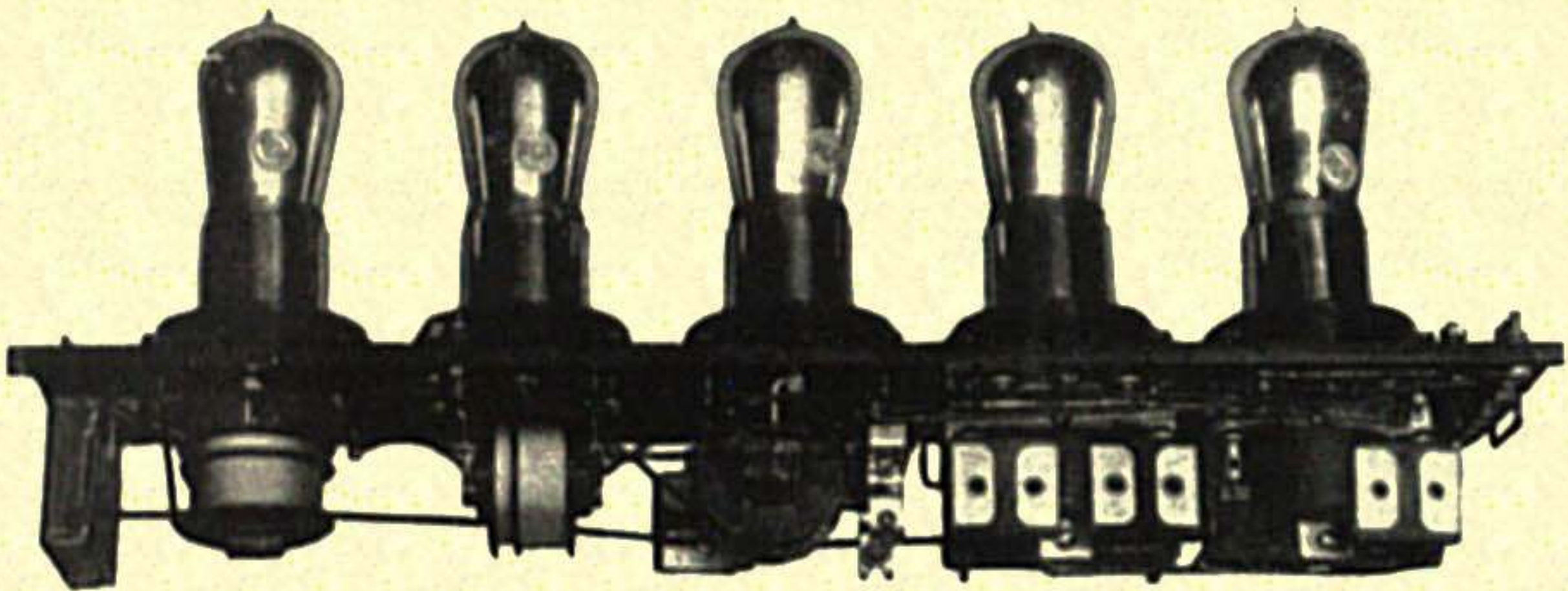

Fig. 62

Exterior and interior views of the PALMAR Long Wave Amplifier. This consists of two stages long wave amplification, detector and two stages of audio frequency amplification, completely wired as a unit. While primarily a long wave unit, this amplifier or any long wave amplifier can be adapted to super-heterodyne reception. This adaption is shown by figures 63, 64 and 65.

While the tubes shown are UV201A's, dry cell tubes can be used if necessary, by providing adapters. Links are provided at which points rheostats can be inserted for Volume and Master Control. The entire unit is contained in a shielding case. The dimensions of the unit proper are approximately $17\frac{3}{4}$ by 3 by 3 inches and by including this unit a complete receiver can be made in a very small space.

transformer and so designed to give distortionless amplification over the average musical frequency range. The quality of reproduction is excellent. Fig. 33 is the Special Weston Multiple Voltmeter. This Voltmeter is their Model 301 Flush instrument with double scale, 0-7.5 volts and 0-150 volts Direct current. A special ratchet switch is provided so that the voltmeter can be switched to four different circuits. The first three are for filament voltage readings and the fourth for Plate Battery reading. In this fourth position a multiplying resistance is connected in circuit with the voltmeter automatically. The Multiplier is built in the special switch.

Fig. 34 shows the General Radio Type 156 Socket. This was the first socket available with side contacts instead of the usual end contacts. For this reason it functions equally well regardless of tube prong lengths. This is without any doubt, the best socket made for experimental purposes. The base is moulded from genuine Bakelite, which will not melt if the terminals are soldered.

Fig. 35 is the General Radio Type 214A Rheostat; this is the highest priced rheostat on the market, but is also the best. The base is moulded from genuine Bakelite. The windings are on a special insulating form and so shaped to give maximum cooling effect. The resistance wire is of a zero temperature co-efficient, that is the resistance does not change with temperature. The metal parts are all solid brass heavily nickel-plated. The knob is moulded Bakelite. The standard resistances are 7 and 20 ohms but the rheostat can be supplied wound to any special resistance value. The type 214A Potentiometer is shown in Fig. 36. This Potentiometer is wound on the same form as the 214 Rheostat, and the general construction is the same. Fig. 36 also shows the standard Type C Radio Frequency Coupler. This coupler has two windings each identical in inductance value and each tuned with a fixed condenser of .00025 MF in shunt which gives a frequency of 47,000 cycles. When these two circuits are in exact resonance the tuning is sharp, however, if one differs from the other the resulting tuning is broad. It has since been found that a different form of coupler is to advantage, such as the Type C7 Output coupler. The Type C7 output coupler can be inserted in a Model C Super-Heterodyne in place of the Radio Frequency Coupler to give greater selectivity. The Primary of the C7 Coupler is connected in place of the Primary of the C RF Coupler and the Secondary of the C7 coupler connected in place of the Secondary of the C RF Coupler. A .01 MF Dubilier Type 640 Condenser is connected across the primary terminals of the C7 Coupler and no condenser at all is connected across the secondary

Fig. 37 is a Type C Standard 4" Dial and Knob. The dial is brass, etched to a dark finish resembling Bakelite and the lettering silvered. The knob is a General Radio moulded Bakelite type. The latest knobs have a tapered periphery. In Fig. 38 are shown two type 21K Bypass Condensers. These condensers have a capacity of 1 MF, and are connected around the B Batteries, affording a path of low resistance to the high frequency oscillations instead of the path of high resistance offered by B Batteries. This view also shows a No. 751 Bias battery. These bias batteries are used to fix the grid potential on amplifier tubes. When using UV201A Tubes as audio amplifiers, the grid potential should be about $4\frac{1}{2}$ volts for 90 volts B battery and about 9 volts negative for 120 volts B Battery, otherwise the B Battery drain is excessive and distortion results. In a radio frequency amplifier the grid potential should be as much negative as possible without causing oscillations. In Fig. 39 several types of Dubilier Condensers are shown. The small square condensers are the type 601 and are available in capacities of from .0001 to .006 MF. The oblong shaped condenser is their type 600 and is usually provided in the larger capacities. These condensers are made according to latest manufacturing methods and are thoroughly reliable and efficient. The Dubilier Co. was the first to market Mica Condensers.

Fig. 40 shows adjustable telephone jacks, Weston Plug and Federal Anticapacity switch. There is also shown a Jack Switch which may be used for controlling a filament circuit.

A special shielded Model C or C7 Cabinet is shown in figure 41. 12-ounce copper (this means 12 oz. per square foot), is used throughout. The copper is cut accurately to size and held to the cabinet with escutcheon pins. It is suggested that the copper be first nickel-plated to a dull satin finish and lacquered after fastening to the cabinet. All inside edges of the cabinet are thoroughly covered and arranged to meet squarely at the joints. The panel should also be shielded in a similar manner, only making sure that all the parts such as condenser shafts, rheostat shafts, jacks, binding posts, etc., are clear off the copper by at least $\frac{1}{16}$ of an inch. While it is desirable to have a shielded cabinet, it is not absolutely necessary and not recommended to be undertaken by one who is not a skilled mechanic. The use of a shielded cabinet prevents direct radiation from the oscillator circuit to neighboring receivers.

The base board layout of a Model C Set before wiring is shown in Fig. 42, the panel layout is shown in Fig. 43. In wiring one of these receivers, all the individual parts should be tested before mounting in the receiver; in this manner defects are not present after completion. An in-

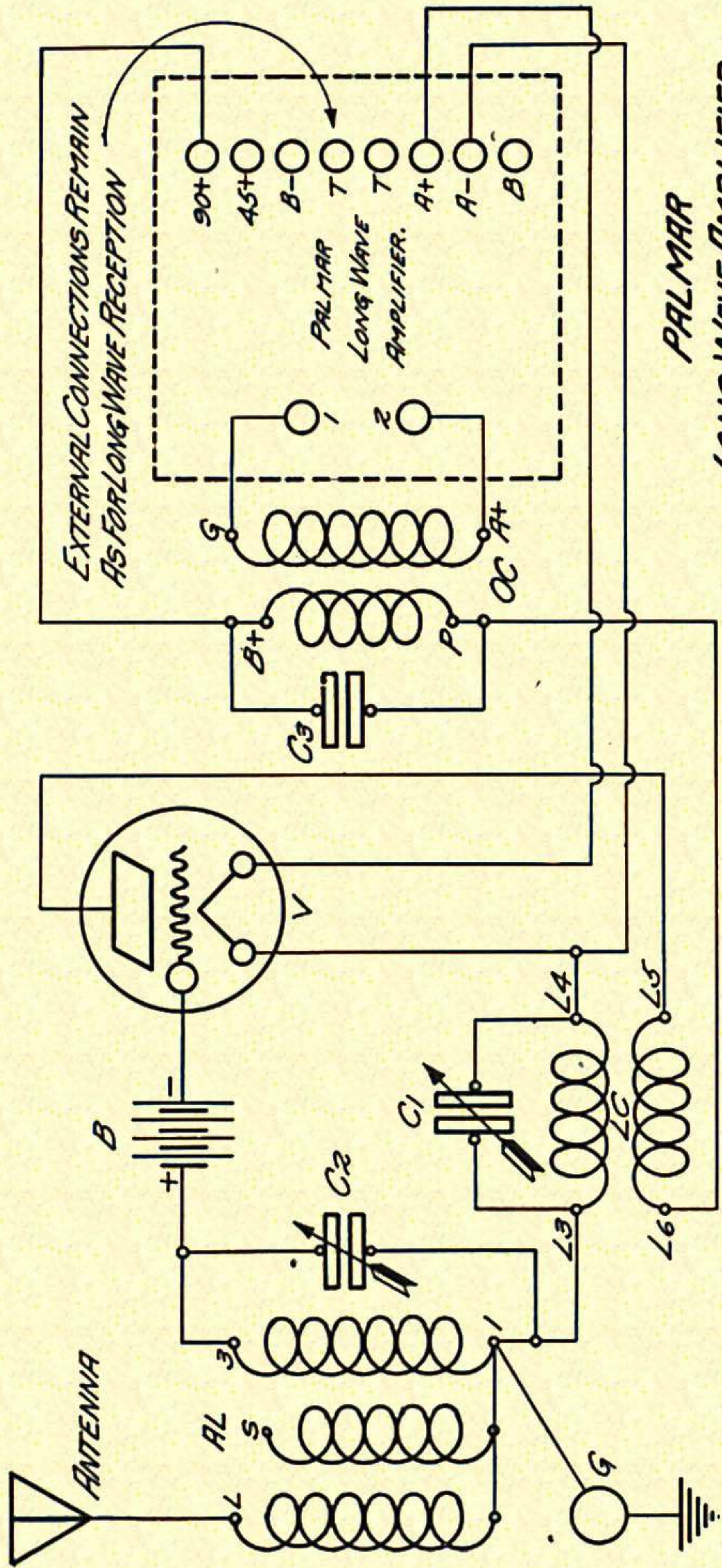

- AL=TYPE C7 ANTENNA INDUCTANCE
- C1=0005 MF. G. R. CONDENSER 247
- C2=00025 MF. G. R. CONDENSER 247
- C3=01 MF. DUBILIER TYPE 601 COND.
- L=TYPE C7 COUPLER-5H/MODEL
- L3=TYPE C7 COUPLER
- L4=TYPE C7 COUPLER
- L5=TYPE C7 COUPLER
- L6=TYPE C7 COUPLER
- B=BIAS OF APPROX. 9 VOLTS-NEG.
- V=UV201A RADIOTRON

**PALMAR
LONG WAVE AMPLIFIER**
SHOWING ADAPTION OF
SECOND HARMONIC SYSTEM
FOR SHORT WAVE RECEPTION
22.5 TO 560 METERS

Fig. 64

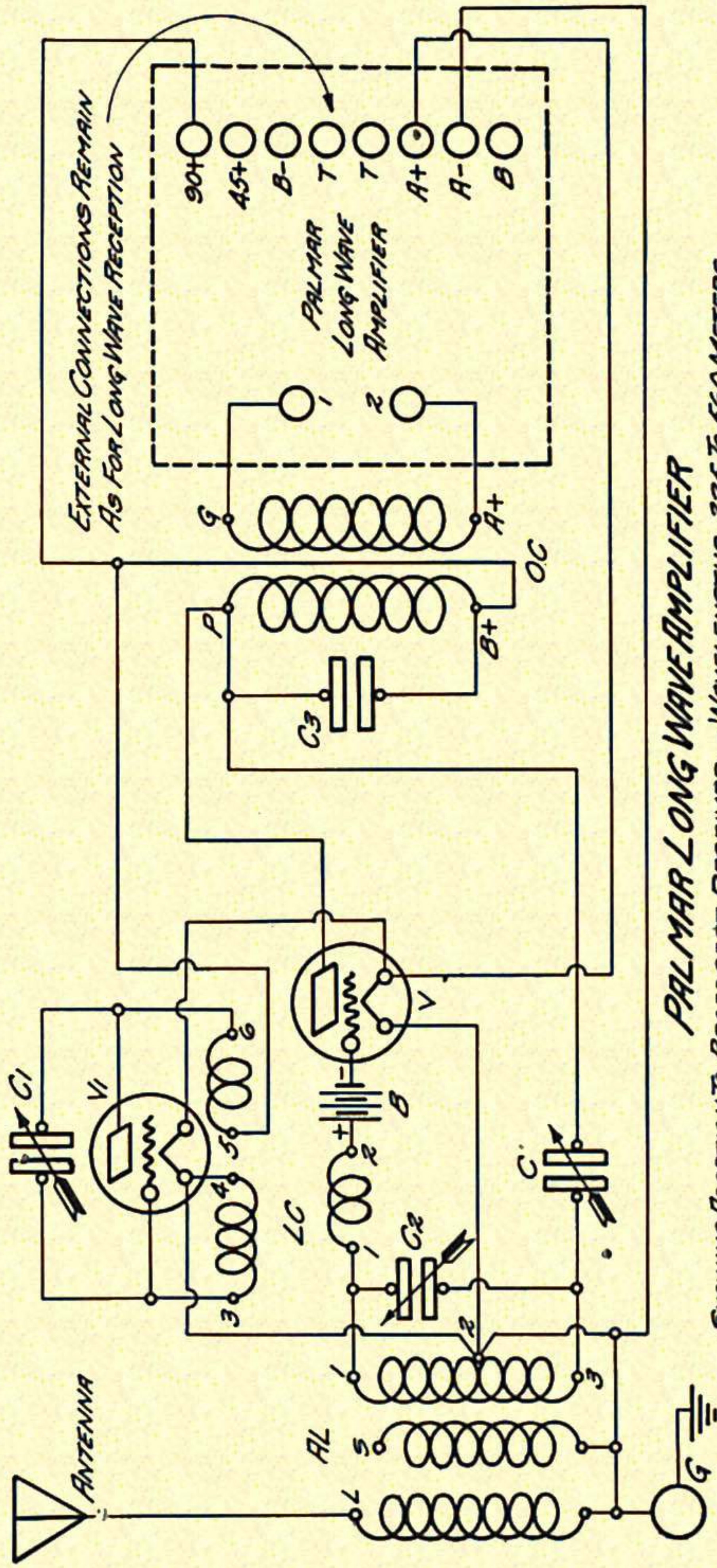

PALMAR LONG WAVE AMPLIFIER

- SHOWING ADAPTION TO BROADCAST RECEIVER - WAVELENGTHS 225 TO 560 METERS
- AL = TYPE C7 ANTENNA INDUCTANCE
- LC = TYPE C7 COUPLER
- B = BIAS OF APPROX. 9 VOLTS - NEG.
- V - V1 = RADIOTRON AND SOCKET
- C1 = .0005 MF. G.R. CONDENSER 247
- C2 = .00025 MF. G.R. CONDENSER 247
- C3 = .01 MF. TYPE 640 DUBILIER COND.
- OC = TYPE C7 OUTPUT COUPLER
- C = .00045 MF. CHELTON CONDENSER

Fig. 65



Manufacturing Formica.

Sheets of impregnated paper being arranged in piles with polished metal plates on each side.

experienced person should take plenty of time and aim for a neat and substantial finished product. When following a wiring diagram it is well to mark the wires inserted in the receiver, on the diagram as one goes along, and it is then readily seen what remains to be inserted. This will insure that nothing is omitted and the progress can be readily checked during the course of wiring. Probably the best system is to wire the filament circuit first and make a preliminary test to determine that this functions properly before proceeding further. In a like manner each wire can be tested with a voltmeter and battery to make sure that it connects the proper points. Fig. 44 is a type C Panel ready for assembly.

Fig. 45 gives all the connections for using the pair of special Jewell Meters with a Model C Super-Heterodyne.

The Western Electric Co. in connection with the American Telephone and Telegraph Co., has probably made greater advances in Broadcasting than all the other interests combined. The quality of reproduction broadcast from station WEAFF is something remarkable and one only has to switch to the Radio Corporation equipped stations WJZ and WJY or to the Westinghouse equipped station WNYC, to note the marked superiority of the WEAFF station. When listening on proper receiving equipment, low notes are received from WEAFF that are entirely absent from the other stations. The General Electric Stations at Schenectady and Oakland and the Westinghouse station at Pittsburgh are perhaps the next best in order named.

The Western Electric Co. has also made excellent progress in the receiving end and for some time has had a Super-Heterodyne receiver known as their type 4B, a condensed wiring diagram of which is shown in Fig. 46. It is believed that their receiver is known as the double detection system and is constructed on the Hammond patents. Their receivers are only sold for commercial purposes and are not available for amateur purposes.

Their 4A Receiver has three intermediate stages of radio frequency amplification and as it was found in actual practice that this was more than sufficient, the later Model known as the 4B Receiver has only two stages of intermediate amplification. It will be noted that this excellent design is free from reflexing. The wiring of the 4B Receiver is shown in Fig. 47. Small peanut tubes are used, all the filaments being connected in series and fed from a $7\frac{1}{2}$ volt supply. The required negative potentials for the various tube grids are obtained along this filament line from the drop. The output of this receiver is fed into a Power Amplifier when it is desired to obtain a large volume of amplification. The selectivity,

quality of reproduction and sensitiveness of this receiver are of a very high order of magnitude. The front view is shown in Fig. 48 and the rear in Fig. 49. In the rear view it will be noted that the two Condensers are the General Radio Co.'s type 247; high grade condensers for a high grade set. In the lower center is the Oscillator tube inverted to facilitate mounting. The small inductance tube is the Oscillator Coupler, a Bypass Condenser is located in back of the Oscillator tube. In the upper half, right to left, the first tube is the first detector, the next two are intermediate amplifiers, the fourth tube is the second detector and the last tube an audio amplifier. One stage of audio amplification is used in the set only, as the additional necessary audio amplification is supplied by an external power amplifier such as the 14A or 10A. The units behind the first and second upper tubes are intermediate radio frequency transformers and the unit behind the third tube is the tuned output transformer. The condenser which tunes the primary of this transformer can be seen fastened to the panel to the right of the output transformer. The Grid leak and condenser for the second detector are in plain view and the audio transformer is located behind the last tube. A rheostat is supplied to regulate the filament temperature and works as a Master. A series of resistances, adjustable by steps, is connected around the primary of the first intermediate transformer, providing a control over the signal intensity. It will be noted that the first detector circuit is a split circuit and normally would oscillate continually due to the grid plate coupling provided by the split loop. However, oscillations are prevented by a balancing condenser which just keeps this circuit below the point of oscillations. At this point the detector works at maximum sensitiveness and adds regenerative amplification. This condenser is of very small value and consists of two wires insulated from each other and twisted together to give capacity. The exact amount of twisted wire is determined by experiment and the excess cut-off. This twisted wire can be seen in the upper right-hand corner just above the shielding.

In the Model C Receiver it requires some practice to adjust the amplifier properly for maximum sensitiveness. To offset this and to further simplify the entire unit, the Type C7 Super-Heterodyne has been developed and in general it is quite similar to the Type 4B. Inasmuch as a Loop requires considerable space, is unsightly and will not work in all locations, the C7 has been designed to work on either a short indoor antenna or a large outdoor antenna.

Fig. 51 is a front view of the standard Model C7 Receiver and Fig. 52 the rear view of the same set. Figs. 53 and 54 show a special C7 which is the same as the standard set except that it is built in a special

cabinet and all the component parts, such as Variable Condensers, Oscillator Coupler, Intermediate Transformers, Output Coupler and Audio Transformers are housed in a shielded container. The cabinet is also entirely shielded. The binding posts are arranged to come out at the rear and jacks are provided to use one, two or no stages of audio amplification.

Referring to Fig. 52 in parts as seen right to left are as follows: Antenna Inductance—Osc. Tube, Heterodyne Condenser directly in back of it—Oscillator Coupler with Balancing Condenser directly above it—1st Detector Tube with Wavelength Condenser directly in back of it—1st Intermediate Transformer, 1st Intermediate Amplifier Tube, 2nd Intermediate Transformer—2nd Intermediate Amplifier Tube—Output Coupler—Detector Tube—Both Audio Transformers and Audio Amplifier Tubes.

The question of shielding is simply a matter of choice and while it adds somewhat to the operation of the receiver it is not recommended unless one is willing to take plenty of time to accomplish a neat shielding job.

In the near future, Antenna Inductances and Oscillator Couplers for the C7 will be supplied in a removable fixture so that different sized coils can be readily substituted to cover different wavelength ranges. In this manner it will be possible for experimenters and amateurs to listen for the low wave transmission from Europe without any local interference. Fig. 55 is a calibration of a typical C7 set, these calibrations vary with each set. Fig. 56 is a Special C7 installed in the home of the writer, the house is wired to have loud speaker outlets in any of the rooms. The battery supply is tapped from the laboratory.

The operation of a C7 can be plainly seen from the Calibration chart Fig. 55. There is a distinct position on the Wavelength dial for each Transmitting station. There are two distinct positions on the Heterodyne Dial for each Transmitting station. After these positions have been experimentally determined for a number of stations, it is an easy matter to turn to any desired station.

An experienced operator tuning one of these receivers for the first time would immediately judge same as tuning "broad," yet with a little practice it is possible to receive distance stations through local stations on close wavelengths, for example 400, 405 meters, 390, 395 meters, 309, 312 meters, 350, 360, 370, 380 meters, etc., and without the least interference from the local stations. When using a short antenna, it should be connected to binding post "S." If using a long antenna it should be connected to post "L" and the short antenna disconnected. When an

antenna is over 125 feet long it is best to run it to a .00025 MF fixed condenser and the other side of this fixed condenser run to post "L." This reduces the total antenna capacity and allows sharper tuning on the wavelength dial. The "Volume" or "Regeneration" Condenser should always be set so that when the Heterodyne dial is rotated, there will *not* be a series of beat notes audible in the phones or loudspeaker.

In passing from the 405 meter station to the 390 meter station it is of course possible to tune in the 400, and 395 meter stations between if they are operating at the time.

The length of antenna used directly affects the calibrations of the Wavelength Dial. The dials should always be set at 100 when the plates are meshed full and flush. The Heterodyne calibrations are not affected by change of antenna. When using a long antenna, it is practically impossible to tune to the lower wavelengths without using a series antenna condenser. It is good practice to provide a series antenna condenser of .00025 MF (Dubilier Type 601) and arrange so that it can be short-circuited with a switch when not required. The antenna runs to one side of the condenser, and the other side of the condenser is connected to the L post on the antenna inductance.

The following table will probably be of help to unexperienced amateurs who have constructed a C7 set. If the drawings (Figs. 83 and 83A) are followed explicitly there will not be any trouble at all, but of course there are always some unlucky experimenters and this data is for their assistance.

1. Always connect a 40-watt 110-volt ordinary house lighting bulb in series with the Negative terminal of the B Battery. That is run the Negative B Battery terminal to one side of the lamp and from the other side of the lamp to the Negative B Terminal on the C7 set. If there is a short circuit in the set, the lamp will light and indicate trouble. If the short circuit happens to be around the filaments, it will protect the 7 tubes from destruction; follow this and save money.

2. Meters reading in wrong direction. Indicates that either meters are connected in wrong polarity, or storage battery leads are reversed at the set A terminals.

3. No action from Heterodyne Dial—Try different tube in Oscillator Circuit—Measure Voltage at Oscillator Tube, from Plate to Filament—Try reversing terminals L5 and L6—Test continuity of Oscillator coils, L1 to L2—L3 to L4—L5 to L6. Make sure tube prongs are engaging socket contacts.

4. No action from Wavelength Dial—Antenna inductance circuit probably incomplete—test continuity of coil No. 1 to No. 3 and associated connections. Make sure condenser is not short-circuited by a wrong connection.

5. No Action from Regeneration Condenser—Test condenser by adding temporary wire pig tail connection between rotor plates and rotor connection—Measure B battery voltage.

6. Signals weak—Test each intermediate Radio Frequency Transformer for continuity of both primary and secondaries with voltmeter and battery. Reverse direction of one or both primaries and note difference. Look for bad tube.

7. Audio Amplifier distorted—Bias battery low, B battery low—reverse direction of primary terminals of one or both audio transformers and note difference.

8. Tuning Broad—Insert antenna series condenser, or reduce length of antenna.

9. Four tuning points on Heterodyne Dial instead of two. This indicates that the output transformer is not tuned to the same wavelength as the intermediate transformer. This can usually be corrected by adding a small condenser in parallel to the .01 MF Condenser around the primary of the output transformer, such as a Dubilier Type 601 .00025 MF.

10. "Dripping" sound during operation—This indicates that a grid circuit is open in one of the tubes. Determine that all grid coils are properly connected, that grid leaks are operating.

11. Short Circuit in B Battery line as indicated by protective lamp lighting—Test all Bypass Condensers for short circuit. Condensers should not give any reading when tested in series with a Voltmeter and battery, although they will give the meter a small accumulative "kick" on charging or discharging. A Weston Model No. 489 Double Range Voltmeter is very handy to have for testing circuits and instruments for defects.

12. With 90-volt B Battery and 45-volt tap for Detector the voltages between the Plates of the various tubes and negative filament are as follows: (Using UV201A Tubes throughout)

85 Volts Supply to Amplifier.

30 Volts Supply to Detector.

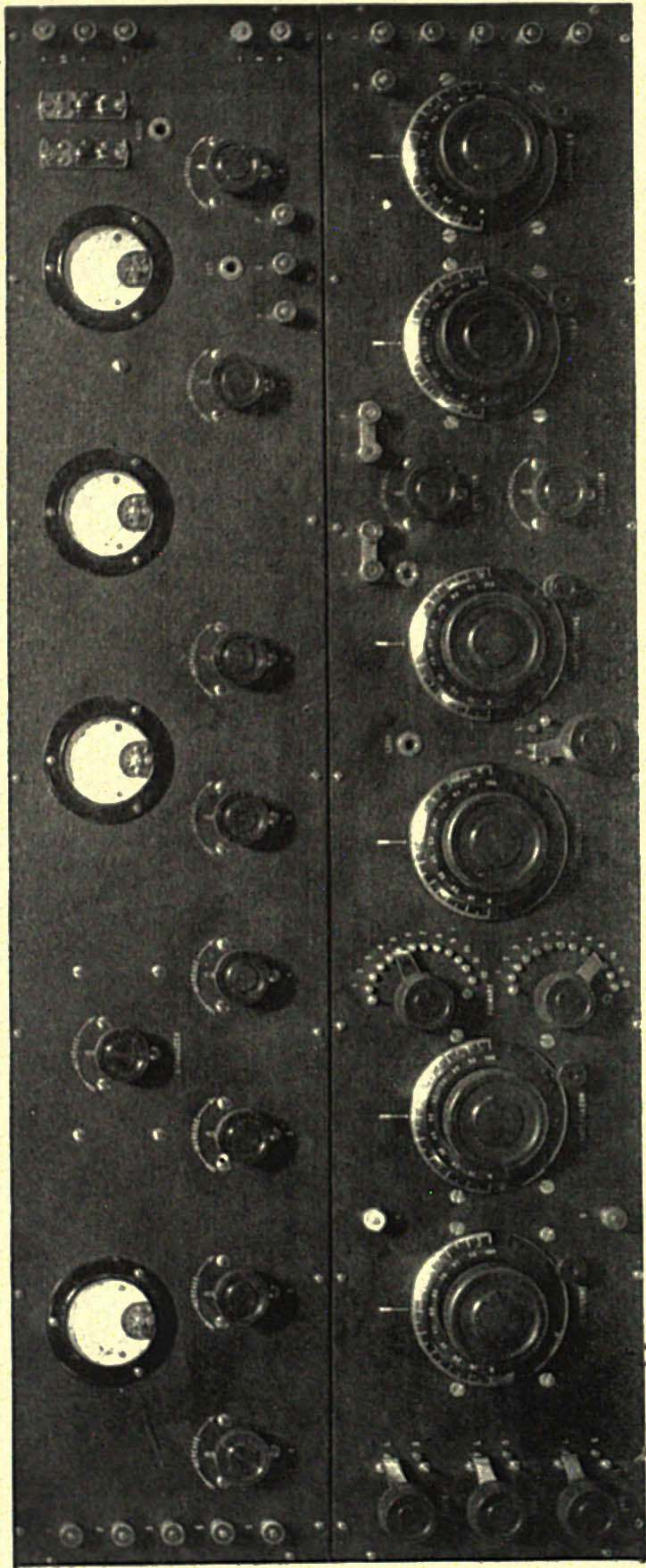

Fig. 66

Model L-Super-Heterodyne, containing six stages of R. F. Amplification and one audio amplifier, two detectors and oscillator.

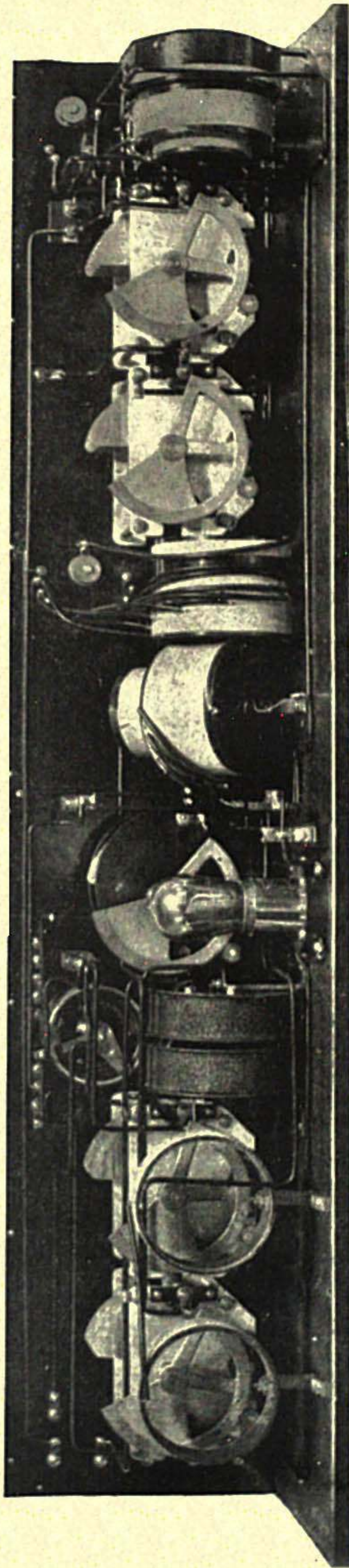

Fig. 67

Model L Super Heterodyne, rear view Receiver Section. Component parts, right to left, Oscillator Coupler, Oscillator Condenser, Antenna Tuning Condenser, Primary Load Coil, Antenna Coupler, Secondary Tuning Condenser, Detector Tube, Input Coupler, Secondary Load Inductances and Input Tuning Condensers. Oscillator Tube is located in back of the Oscillator Coupler. In the latest design of this type receiver, it is recommended that all the component parts be individually shielded, as well as the interior surfaces of the cabinet and back of panel.

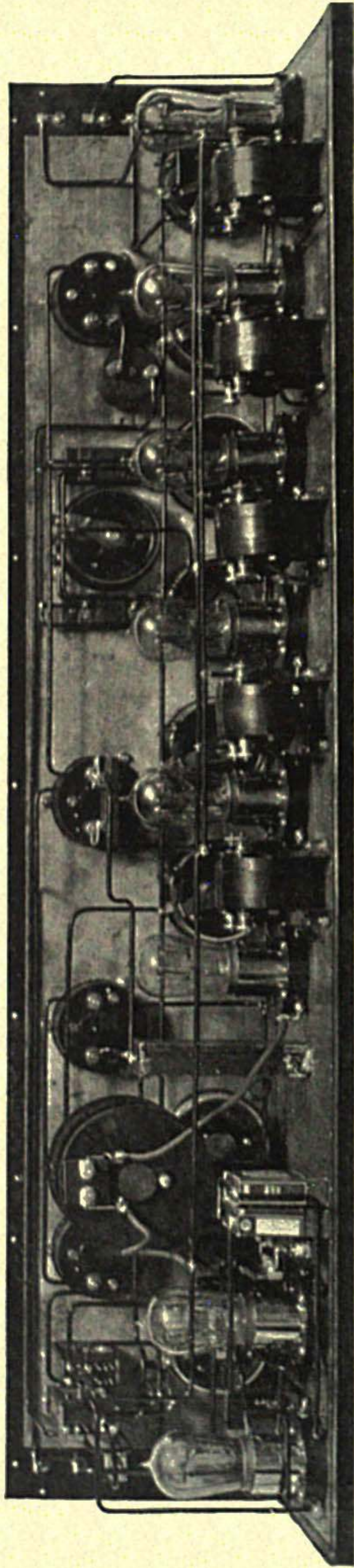

Fig. 68

Model L Super-Heterodyne, rear view amplifier section. In the latest design of this type receiver, it is recommended that the Radio Frequency Transformers each be individually shielded in iron cases. The output transformer should be contained in a copper shielding case. The audio transformers should be shielded in iron cases. The interior surfaces of the cabinet and rear of panel should be shielded with 10-ounce copper.

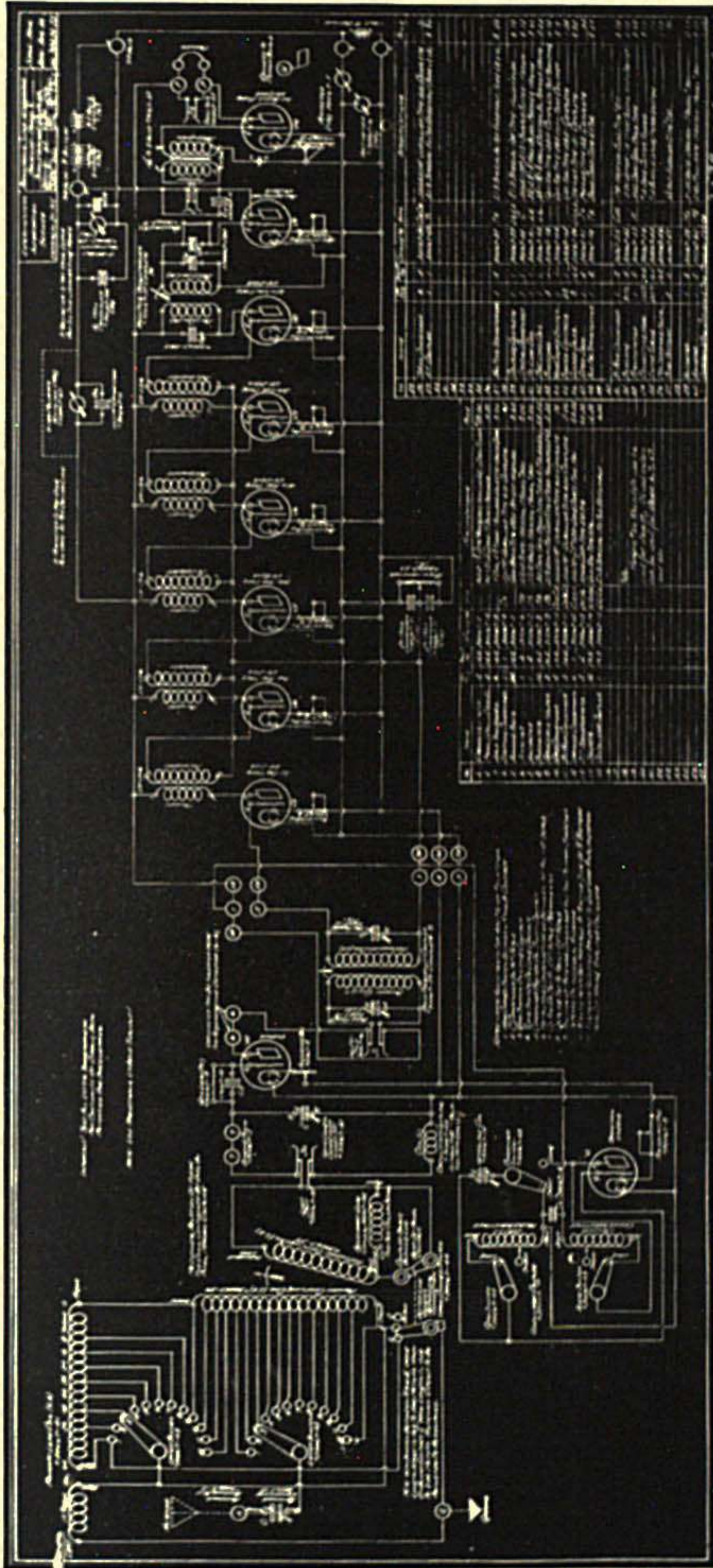

Fig. 69

Schematic Wiring Diagram Model "L" Super-Heterodyne-Experimenters Information Service Drawing 30074-75.

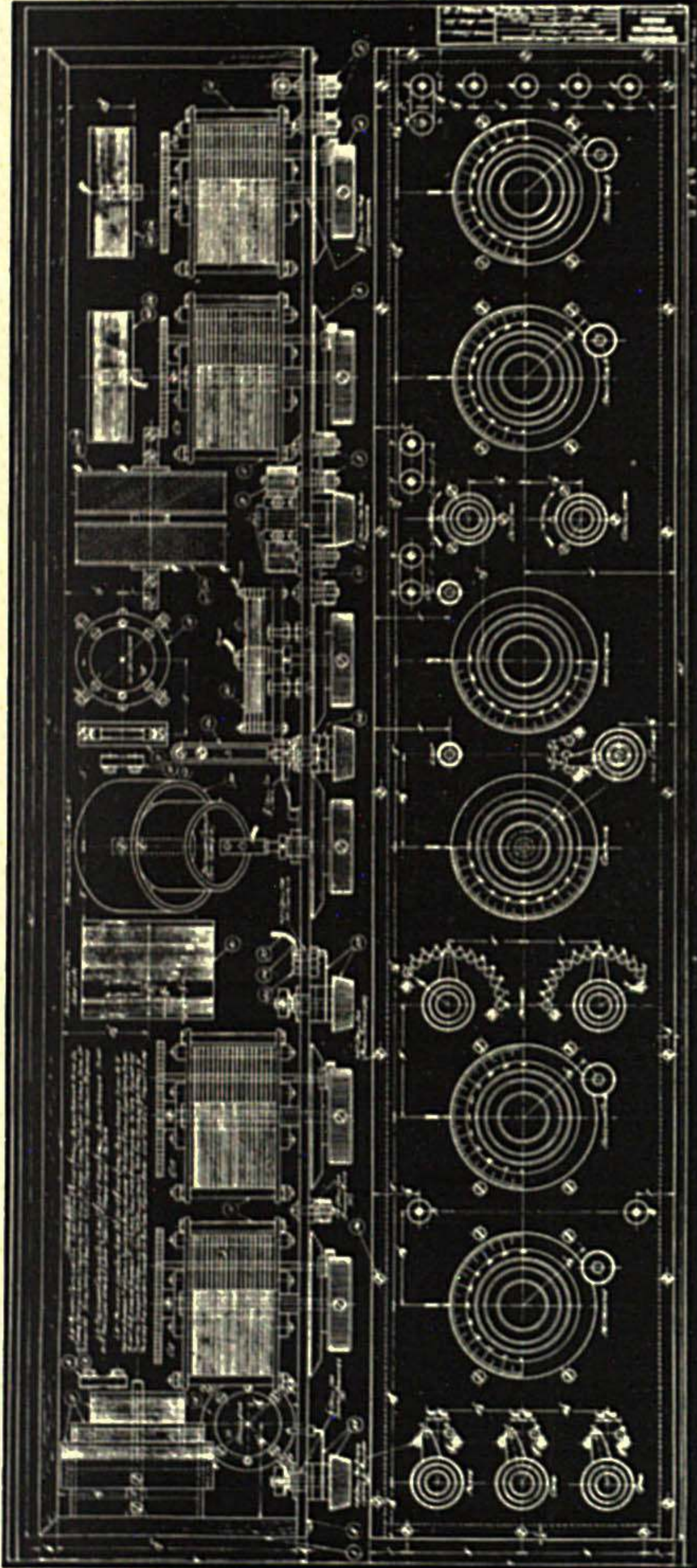
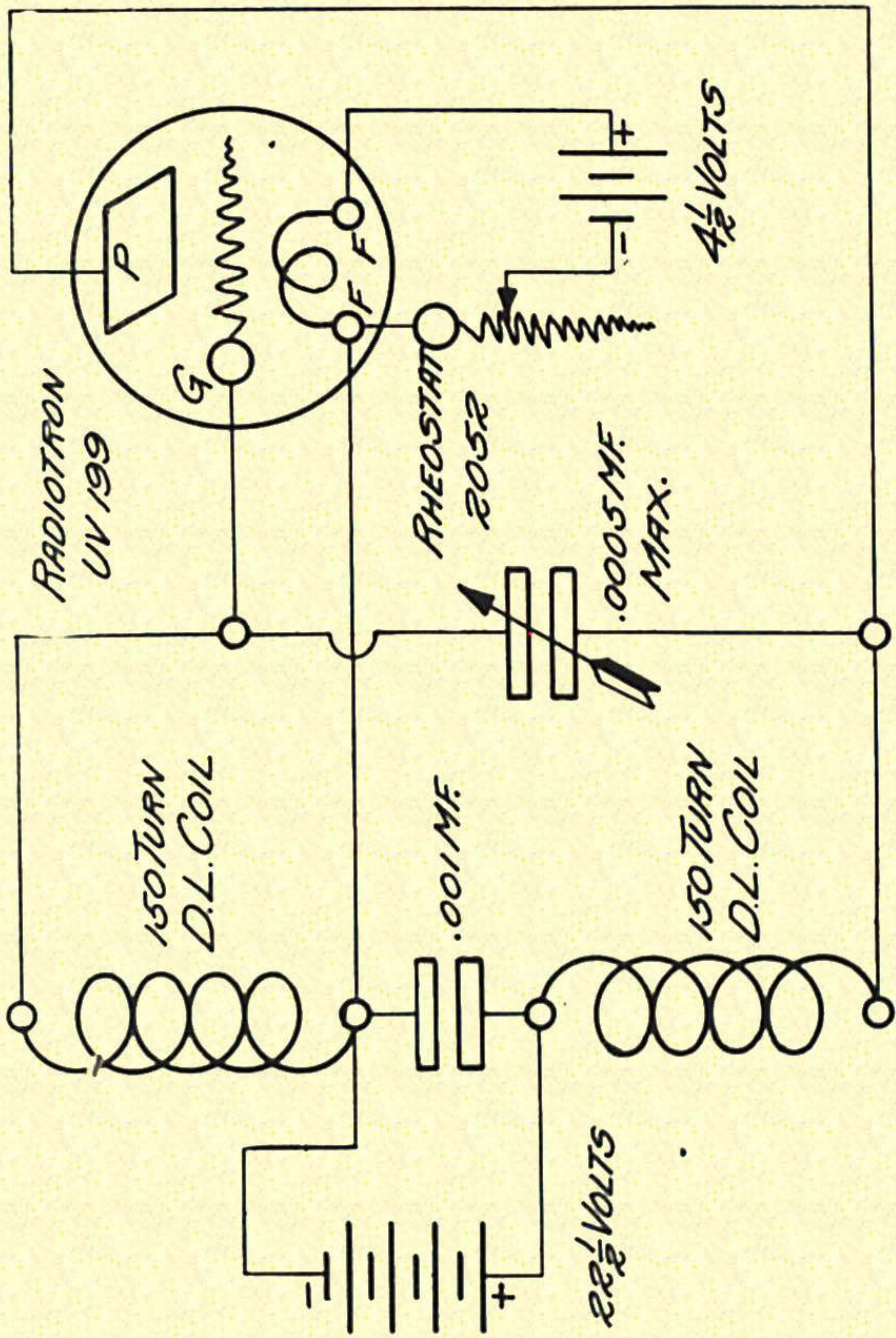

Fig. 70
Receiver Section Model "L" Super-Heterodyne. Reproduction of Assembly Blue Print.



SEPARATE OSCILLATOR FOR C.W. TELEGRAPH RECEPTION.

Fig. 71

Tube	Volts	Milliamperes Plate
Oscillator UV201A.....	85	10
Detector UV201A.....	85	2
Amplifier 1 UV201A.....	83	2
Amplifier 2 UV201A.....	83	2
Detector	29	1
Audio	75	2
Audio	75	2

The above readings will vary with different and individual tubes but are useful for comparative purposes.

If it is impossible to stop the series of whistles or beat notes with the Regeneration Control, a slight reduction on the Volume or Master Rheostat should prevent them. In the first instance, the Regeneration Control stops the Detector Circuit from oscillation and in the second instance, a reduction in filament temperature prevents the Intermediate Amplifier from oscillating.

When tuning is carried on in the following manner, it is possible to log all stations that are operating and within range. Set Master Rheostat practically full on, set Volume Rheostat three-quarter full on, Set Wavelength Dial at 10° and rotate Heterodyne Dial slowly from 0° to 30° , preferably use phones for listening when learning to tune. At two points on the Heterodyne dial there will be noticed a "rushing" sound in the phones, and this indicates that all circuits are in proper resonance—that the receiver is tuned to a certain wavelength—and that static is being brought in at that wavelength.

Now move the Wavelength Dial up one degree and vary the Heterodyne Dial again and it will be noticed that the two "rushing" sound points on the Heterodyne Dial have moved up the scale slightly. It will also be noticed that these two points are slightly further apart. The volume of the static received can be regulated by the Regeneration Condenser Control, Volume Control and Master Control, these should be regulated for maximum static so that the receiver is in a sensitive condition.

Carry this operation on thoroughly either in one division steps or one half division steps on the Wavelength Dial. Later when doing very close tuning the operation should be carried on in $\frac{1}{4}$ degree divisions on the Wavelength Dial. Assuming that the receiver in question has the

calibration shown in Fig. 55, when the Wavelength Dial is set at 15° , the two Heterodyne tuning points will come at $23\frac{1}{2}$ and $21\frac{1}{2}$ and the receiver is then tuned to WSAI Cincinnati. (Note that these two points are 8 divisions apart.) Taking an example further up the scale, with the Wavelength Dial set at $55\frac{1}{2}^\circ$ the two Heterodyne points will tune at 47 and 65° which is the wavelength of CNRO Ottawa. Note these two points are $17\frac{1}{2}$ divisions apart. At the other end of the Wavelength Dial, set at 86, the Heterodyne points are found at 62 and 88 which is the wave-length of WIP in Philadelphia, these two points are 26 degrees apart.

It will be noted from the calibrations that the upper Heterodyne "hump" of CNRO is 65 and the lower "hump" of WNYC is $64\frac{1}{2}$ and if the signals from both were strong and the Wavelength dial in such a position that it would tune partially to either one, the high wavelength station WNYC would be heard before the lower wavelength station CNRO although the Heterodyne Dial was being rotated in the increase wavelength direction. This is confusing to the novice and he usually concludes that the receiver is "broad" or wrong. By carefully following the system of tuning suggested above, excellent results can be obtained.

Furthermore if one station is logged and its wavelength known these calibrations may be utilized to locate stations operating on a neighboring wavelength. For example WOR on 405 meters is located at 47 on Wavelength Dial and 42 or 56 on the Heterodyne Dial. WTAM on 390 meter is slightly lower on the scales, accordingly by reducing the Wavelength dial slightly and correspondingly decrease the Heterodyne Dial, the 390 meter station will be located at 43 on the Wavelength Dial and 41 or 53 on the Heterodyne Dial.

If this brings the two pairs of two points into two distinct points the circuit is then properly tuned. If it brings the two points further apart, in a pair, the correction is being made in the wrong direction and instead of adding a condenser, the .01 MF condenser should be removed and a .0075 MF Condenser substituted.

Fig. 57 gives the Oscillatory Current in a C7 Oscillator circuit using an average UV201A Tube with 90-volt plate voltage. The curve also shows the oscillator current in a Radiola Super-Heterodyne which uses a UV199 Radiotron with 90-volt plate voltage.

A standard C7 Antenna Inductance is shown in Fig. 58. This consists of two Genuine Formica Tubes one within the other. The outer tube carries the secondary winding of Litzendraht, tapped in the center to suit the C7 receiver or other circuits requiring a split winding. The

inner tube has two windings, one of 40 turns for the Short Antenna connection and one of 20 turns for the long antenna connection. The secondary winding has a total of 120 turns. Both tubes are $2\frac{3}{8}$ " long, the larger tube 2" diam. and the smaller $1\frac{3}{4}$ " diam., wall thickness $\frac{1}{8}$ " in each case. This inductance can also be used as an excellent tuned Radio Frequency Amplifying Transformer as shown in accompanying diagrams.

The C7 Coupler is shown in Fig. 59. This inductive coupler can be used for a number of purposes, such as an Antenna Inductance, Tuned Radio Frequency Transformer or Oscillator Coupler. The windings are on a heavy Formica Tube, consisting of three independent windings brought out to a terminal block. Two of the windings are identical and are really secondaries and the third winding is of a few turns and may be considered as a primary. The primary has five turns bank wound and each of the secondaries has 30 turns banked.

The C7 Output coupler is pictured in Fig. 60. This unit can be used as an Antenna Inductance for Long Wave Reception, also as a Tuned Radio Frequency Transformer for Long Wave Reception and also as a Tuned Filter, or Output Coupler in the C7 Receiver. The various uses of these three units are shown in schematic wiring diagrams in this chapter, Figs. 64 and 65.

The C7 Antenna Inductance and C7 Coupler are available in several different sizes allowing various wavelength ranges down to about 50 meters. They are equipped with plug contacts and a socket and one size can be readily substituted for another to change the wavelength range.

The Output Coupler or Transformer can be used as a Tuned Filter in any Amplifier Circuit by properly tuning the Primary with suitable condensers, tuning this primary circuit to the peak wavelength of the intermediate transformers used.

A New Long Wave Amplifier is now on the market and is well adapted to all long wave experiments. The PALMAR Long Wave Amplifier is shown in Figs. 61 and 62 and the various experimental circuits are shown in wiring diagrams in Figs. 63, 64 and 65. This amplifier consists of two stages of long wave radio frequency amplification, detector and two stages of audio amplification. All the component parts are self-contained in a metal case which provides shielding. All the component parts are wired and outlet terminals are provided where the A, B, and C Batteries are connected. Two terminals are provided for the output and they run either to a pair of phones or a speaker. Links are provided to open the circuit to insert rheostats. A 20-ohm rheostat can be inserted in the

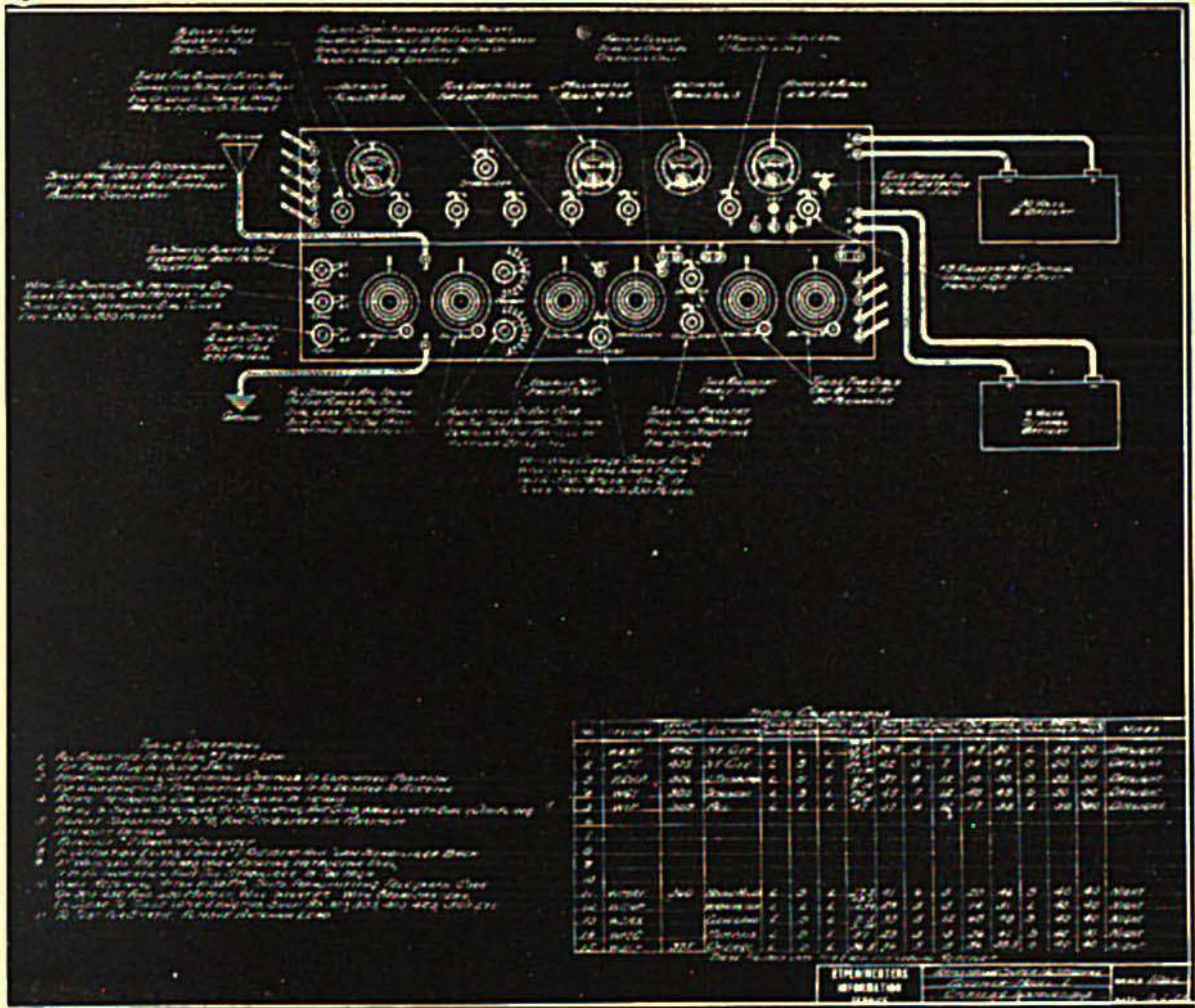

Fig. 72

link at the second RF Amplifier tube to control volume. A seven-ohm rheostat can be inserted at the other link to give a Master control on all the filaments. The input terminals 1 and 2 are used to accommodate an input tuning circuit. The amplifier if connected as per the diagrams shown, is non-regenerative. UV201A Radiotrons are best adapted, but UV199 Radiotrons can be used with socket adapters with proportional results.

It will be noted that this Long Wave Amplifier can be incorporated as the amplifier system in a Super-Heterodyne Receiver, both the standard type or as a Second Harmonic Super-Heterodyne. In the first case two additional tubes are required and in the second case, one additional tube, the system using two additional tubes and the straight oscillator is recommended in preference to the Second Harmonic Oscillator System for reasons mentioned elsewhere in this book.

The Model L Super-Heterodyne was designed principally for the experienced operator and the proper control of its component parts calls for considerable skill to obtain maximum results. The adjustment of the low frequency amplifier is the most difficult operation and once that is correct the other operations are just as simple as those of the Model C Receiver.

Fig. 66 shows the front view of the complete receiver in two units, each 40" by 8" by 8", the Amplifier Half being placed upon the Receiver Half. While it is quite possible to obtain very good results with the two units one upon the other, the best position is to have the Amplifier Half to the right of the Receiver Half. It simplifies the space question by placing them at right angles in a corner.

Referring to Fig. 66, at the extreme left of the lower section, are three switches; the upper gives two values of Plate inductance in the Oscillator Circuit, the Lower gives two values of inductance in the Oscillator circuit and the Center switch connects the Oscillator or Heterodyne Condenser either across the Plate section of the Oscillator inductance or across both the plate and grid coils together. With the Grid and Plate Switches on "L" position and the Condenser switch on S position, the Heterodyne Condenser covers a wavelength range of from 160 to 500 meters. With the condenser switch on L position this same Heterodyne Condenser covers a wavelength range of from 330 meters to 850 meters. By moving the Grid and Plate switches to S position the range of the condenser scale in wavelengths is still further lowered and the best position of the condenser scale can be selected for maximum results from this particular adjustment.

The second dial from the left on the lower section is the antenna series variable condenser and the two switches to the right of that varying the amount of antenna circuit inductance used. The upper switch varies the inductance in sections and the lower switch varies the inductance in units. When the upper switch is on No. 12 and the lower switch on No. 1, the antenna inductance is adjusted to the minimum. The antenna condenser is connected in series with the antenna inductance and also in series with the antenna and ground. The complete schematic wiring diagram is shown clearly in Fig. 69. With a given antenna and with a certain selection of antenna inductance values, the antenna condenser will cover a range of wavelengths. For example, with an average antenna of .0005 M.F. capacity, using all the antenna inductance, the antenna condenser at 0 will tune to about 400 meters and at 100 on the scale will tune to 850 meters. For lower wavelengths, of course, one would use less antenna inductance and,

tune the antenna circuit to exact resonance by adjusting the Antenna Condenser.

Part of the antenna inductance is concentrated in the primary-secondary variocoupler and the balance concentrated in the primary load coil. The switches permit the use of any desired amount in either section and this insures the selection of the proper coupling coefficient for the different wavelengths.

The next dial controls the mechanical coupling between the primary and secondary circuits. This coupler is of the 180° type. That is, a dial movement of 180 degrees is necessary to secure a coil movement from concentric to right angles. This is the equivalent of a gear motion of two to one and affords a closer adjustment.

Ordinarily it would be thought that the closer the coupling between the primary and secondary circuits the better for greater signal strength. However, this is not true and an experienced operator will always work with the coupling as loose as possible. Loosening the coupling decreases the resistance in both the primary and secondary circuit and this decrease in resistance indirectly permits greater voltages to be developed in the secondary circuit on the detector grid with consequent greater signal strength. There is a point for every wavelength where the decrease in resistance mentioned does not compensate for the energy transfer loss and this is the limit to which the advantage can be secured.

The next dial controls the secondary wavelength. In this secondary circuit which feeds into the first detector, it is necessary to secure the greatest potentials for greatest signal strength. For short wavelengths up to about 850 meters maximum potential is secured by using a large part inductance and a small part capacity or condenser. Accordingly, this tuning condenser is of very small capacity, actually .00027 M.F. maximum, and so designed to have a small minimum capacity, very low losses and also to give a uniform wavelength variation in relation to dial movement. That is at 80 degrees on the scale the wavelength is twice that at 40 degrees. This condenser is connected in parallel to the secondary coupling inductance and the secondary load inductance. When the condenser only is in parallel to the secondary coupling inductance, the condenser covers a wavelength range of from 160 to about 500 meters. With the secondary load brought into the circuit, the condenser covers a wavelength of from about 380 to 850 meters, that is, when the wave change switch is on L. It will be noted that there is a wavelength overlap of 120 meters. With the wavechange switch on S the secondary load coil is short circuited and the wavelength condenser tunes to the lower range.

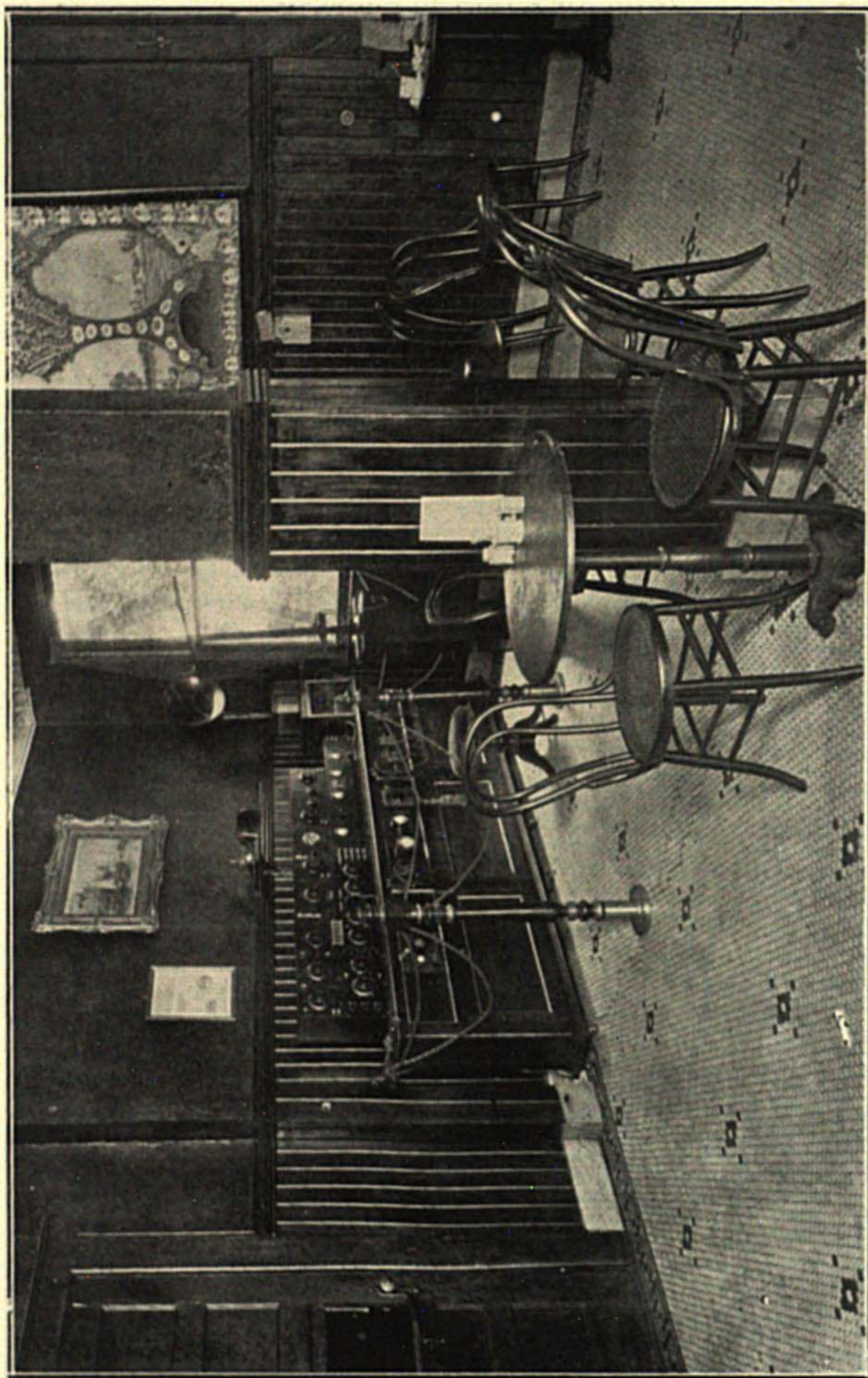

Fig. 73

Super-Heterodyne Receiving Installation in the Dutch Room of the Arlington Hotel, Sheephead Bay, N. Y. This Equipment Was All Assembled by the Owner, Robert J. Seigelack. Due to the Ideal Coast Location, the Consistent Range is Over 2,000 Miles at Night.

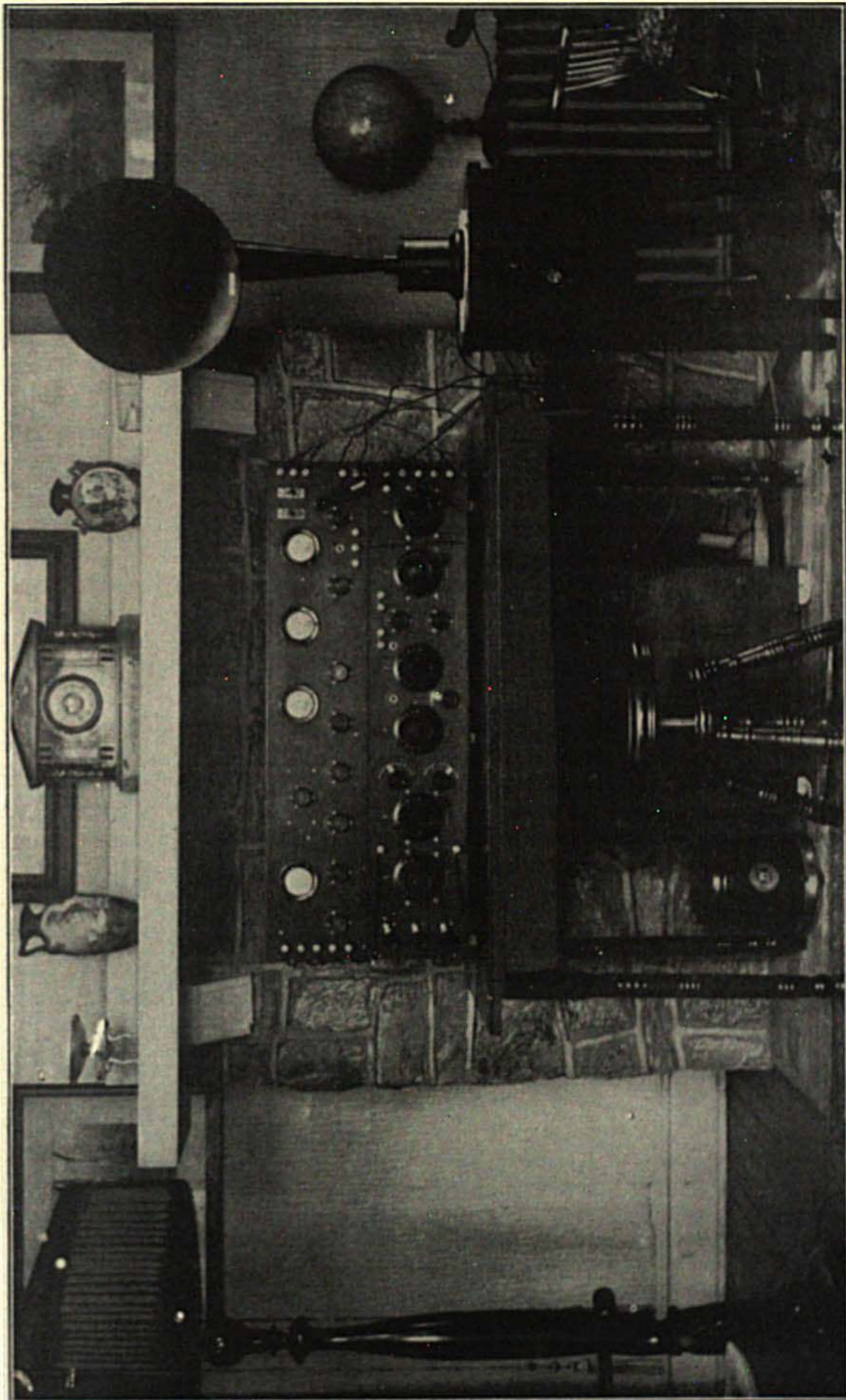

Fig. 74

Residential Installation Model L Super-Heterodyne. Western Electric-10D-Loud Speaker. Rectagon Battery Charger. An Antenna is used with this equipment and a loop can be used if desired.

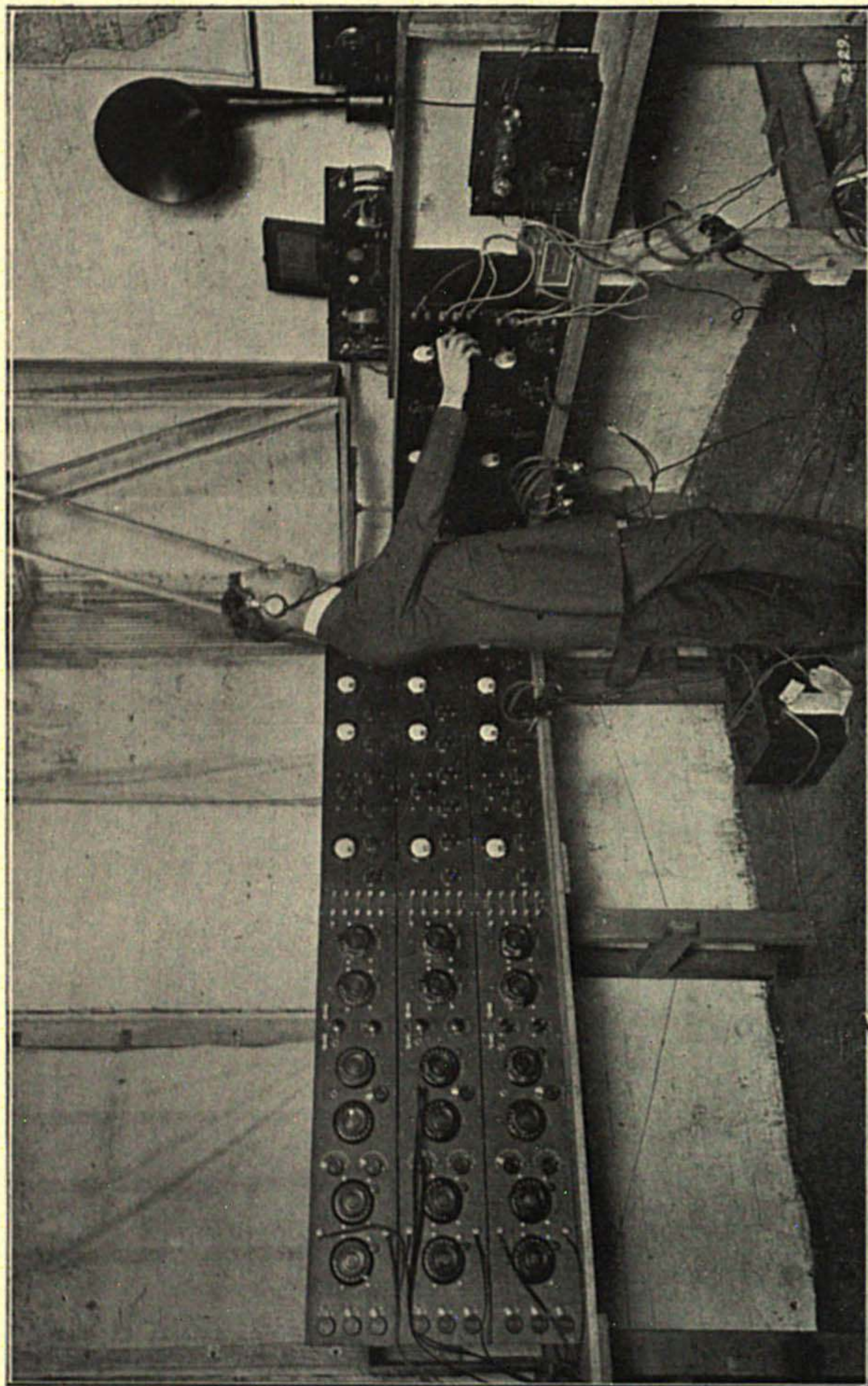

Fig. 75

Super-Heterodynes in the Research Laboratory of the Experimenters' Information Service, New York City. It is Possible to Operate Five of These Receivers Simultaneously in One Room Receiving From Five Different Cities.

A Jack is provided to insert a loop plug for loop reception. When this model L is used for loop reception the Antenna Condenser, Primary Switches and Coupling Controls are automatically disconnected and the adjustments for tuning, narrow down to the Wavelength Condenser which now tunes the Loop and the Heterodyne Condenser for changing the frequencies.

Rheostats are provided for the 1st Detector and for the Heterodyne Oscillator tubes. The adjustments of each will depend upon the tubes used. Radiotrons UV201A or UV199 are recommended throughout with the UV201A's as first choice. Using UV201A's it will be found that the Detector tube will be quite high and the Oscillator filament usually best when as low as possible. Care must be taken not to adjust the Oscillator filament too low or the local oscillations will stop. This will be indicated by not obtaining any action when varying the Heterodyne dial. A Jack is provided in the 1st Detector Plate circuit and the phones can be inserted here for local reception or to test the two-circuit section of the receiver. The link can be removed from binding posts No. 6 and 7 and a variometer inserted here for regenerative amplification in the first detector. This is not recommended unless using the receiver as a one tube set for local reception. Another method of obtaining regenerative amplification is to connect a variocoupler between the grid and plate circuit of the 1st detector. The primary of this coupler being connected to posts 6 and 6 and the secondary between posts 7 and 7. This coupler would consist of about 8 turns on a four-inch disc for both primary and secondary, and arranged so that the coupling could be varied to a sharp minimum. A secondary load inductance can also be inserted between binding posts 6 and 6 for wavelengths slightly higher than 850 meters or to enable using the wavelengths condenser at a better portion of the scale for 600 meter work.

The two variable condensers designated Radio Frequency A and B tune the input coils of the low frequency radio amplifier. It is obvious that there is only one best position for these two condensers and that position is when the input coils of the amplifier are tuned to the same wavelength as the output coils of the amplifier, which are fixed. It works out in practice that this position is approximately 25 degrees to 50 degrees on each scale and varies widely on different receivers. This wavelength is selected with a view to being the peak wavelength of the radio frequency transformers that are in the stages between the input and output of the radio amplifier. Actually the amplification per stage at this low advantageous frequency is equal to tuned radio frequency amplification, sufficiently selective and not so difficult to operate or

construct as an amplifier of the condenser-inductance tuned type. It is perfectly obvious that to tune six stages with individual condensers would be a difficult proposition and, furthermore, it would be impossible to put all condensers on the same shaft as this would mean long leads and feed back coupling which would generate undesirable oscillations.

The purpose of the tuned Radio Frequency Output transformer is two fold. In the first case, without this feature it would be impossible to use six stages of radio frequency to advantage as oscillations would start before full amplification had been obtained. The tuned output enables the six stages to be used to decided advantage and with full control of the amplifier regeneration. The Neutrodyne feature applied would not be to any advantage as far as increase in amplification is concerned, and if the Neutrodyne feature were applied and used without regeneration there would be a decrease in total amplification obtainable. The tuned output transformer also adds to the selectivity of the amplifier. This amplifier could be designed to be still more selective but this would destroy the quality of the music reproduction. The amplifier is sufficiently selective to completely eliminate WOR about 12 miles distance and operating on 405 meters and enable tuning in PWX Havana, 1,300 miles distance, and obtaining full signal strength. When obtaining this result there is only $\frac{3}{4}$ of a degree variation on the Heterodyne dial to change from one station to another. In the daytime, using a loop $2\frac{3}{8}$ " diameter 65 turns, WOR on 405 meters can be eliminated and WFI on 395 meters tuned in (90 miles) with strong response. By strong response the writer has in mind a signal which can be plainly heard 25 or 30 feet from a pair of telephones. A higher degree of selectivity is not necessary, and a degree of selectivity on this order cannot start to be approached by any other type of reception employing radio frequency amplification.

In the upper amplifier section are provided individual rheostats for each of the six amplifier tubes, one for the second detector and one for the audio amplifier. Offhand it might be thought that a master rheostat could be used for the six radio amplifiers. However, due to great difference in characteristics of tubes which are supposed to be identical, the individual rheostat is a necessity, unless the tubes are pre-selected. Four indicating meters are provided; one meter constantly indicates the battery supply voltage under load conditions. An ammeter is supplied which measures the total current consumption from the filament battery, usually slightly less than $\frac{1}{4}$ ampere per tube with UV201A tubes. A potentiometer Stabilizer is provided to control the regenerative amplification in the radio amplifier. This potentiometer

arm fixes the grid potentials on the amplifier tubes and runs from 0 to 6 volts positive. The best adjustment on the stabilizer depends upon the plate voltage being used and the individual adjustments on the amplifier filaments. In actual operation a combination is obtained for best results.

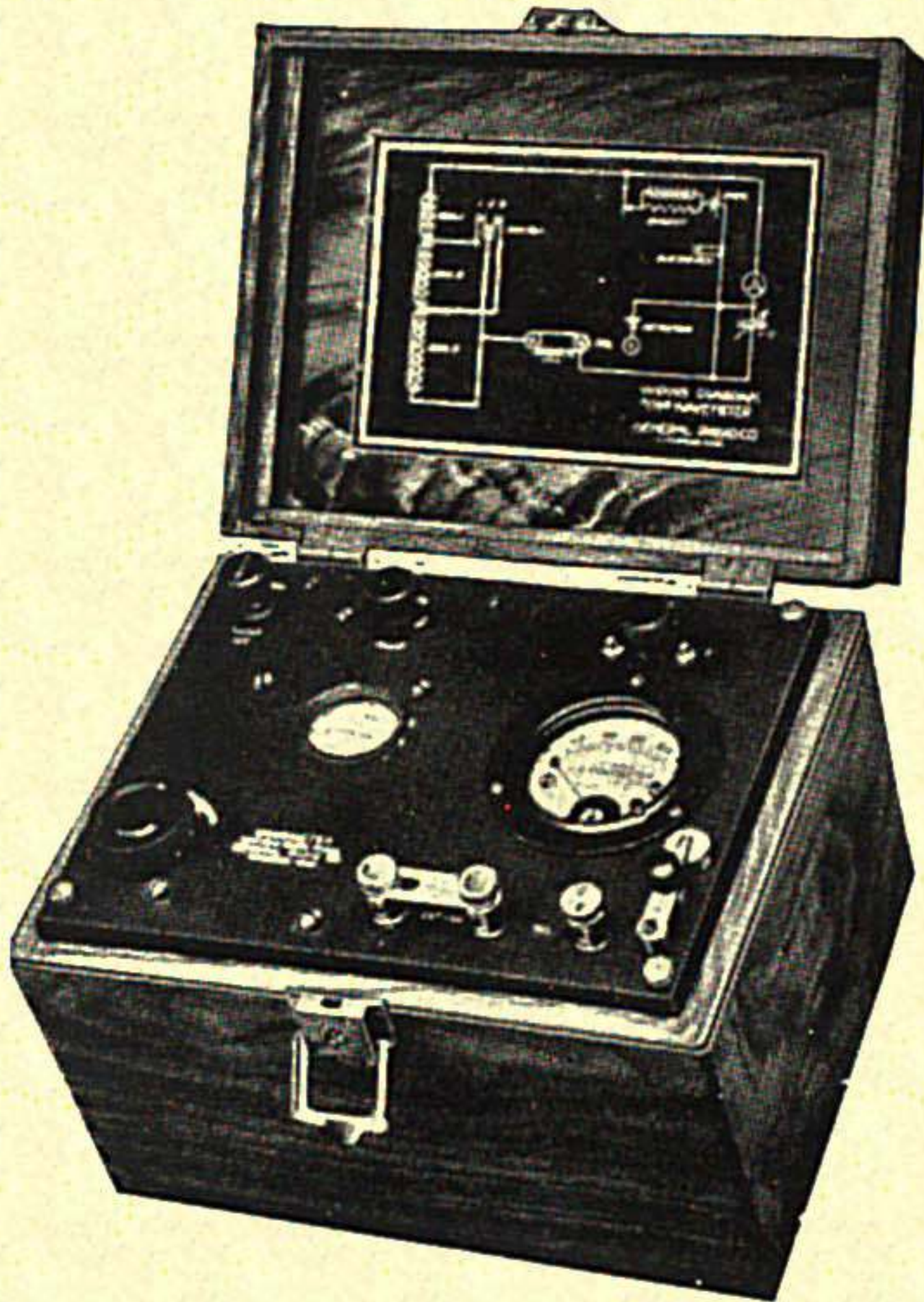

Fig. 76
General Radio Type 174 Wavemeter for Calibrating Super-Heterodyne Receivers

The best procedure is to set the Stabilizer to the positive side of the potentiometer and then regulate the filament temperature of the amplifier and second detector tube for best amplification. The stabilizer can then be moved toward the negative side for increased amplification. The stabilizer must not be moved too far or oscillations will be generated in the amplifier with consequent distortion and loss of signal strength.

For CW Telegraph reception, the amplifier is purposely made to oscillate by bringing the stabilizer negative. The oscillations hetero-

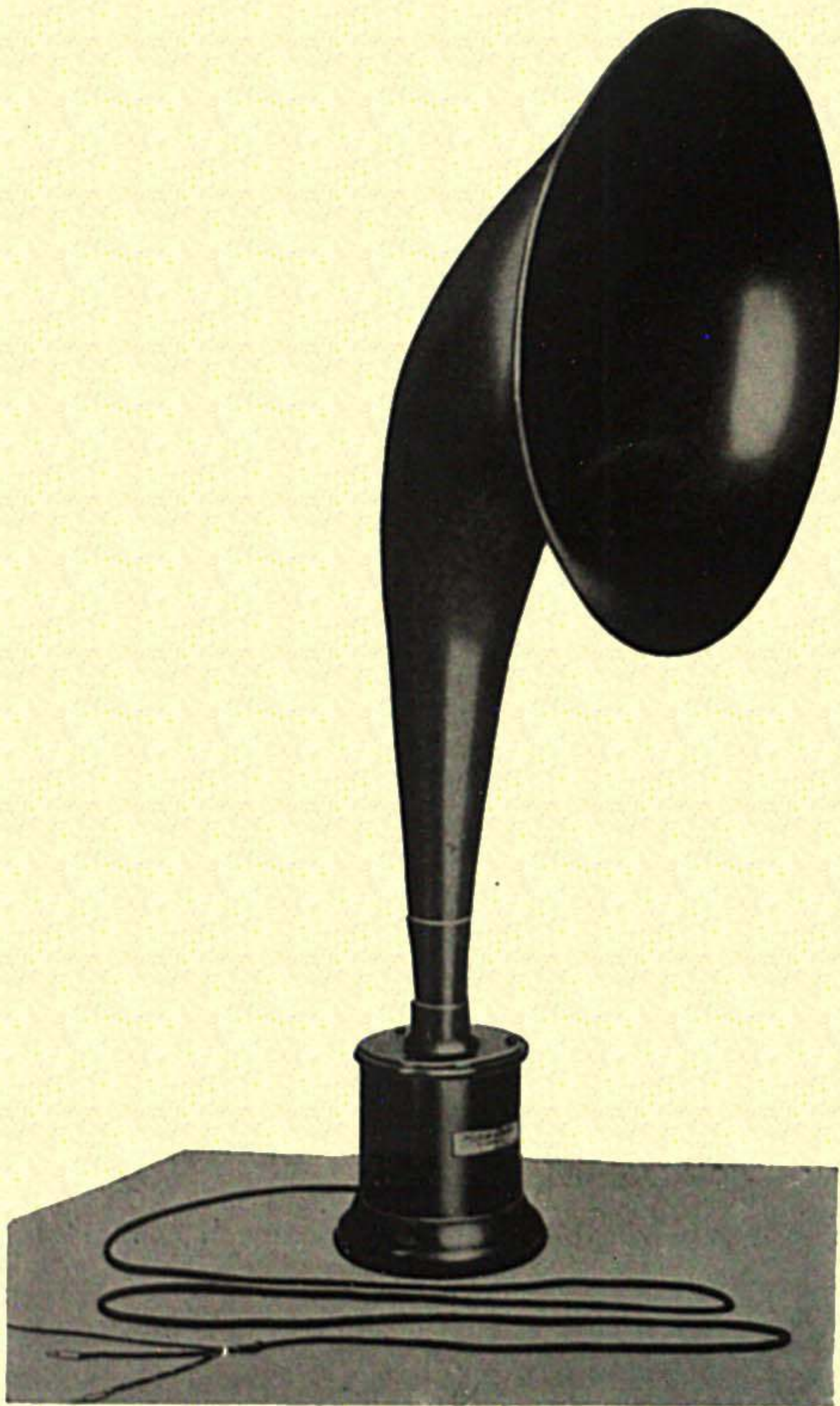

Fig. 77

Western Electric Type 10-D Loud Speaker. A Very Suitable Unit for Use With Model C or L Super-Heterodyne. This Unit Does Not Require Any Power Amplifier Other Than the Audio Amplification in the Super-Heterodynes.

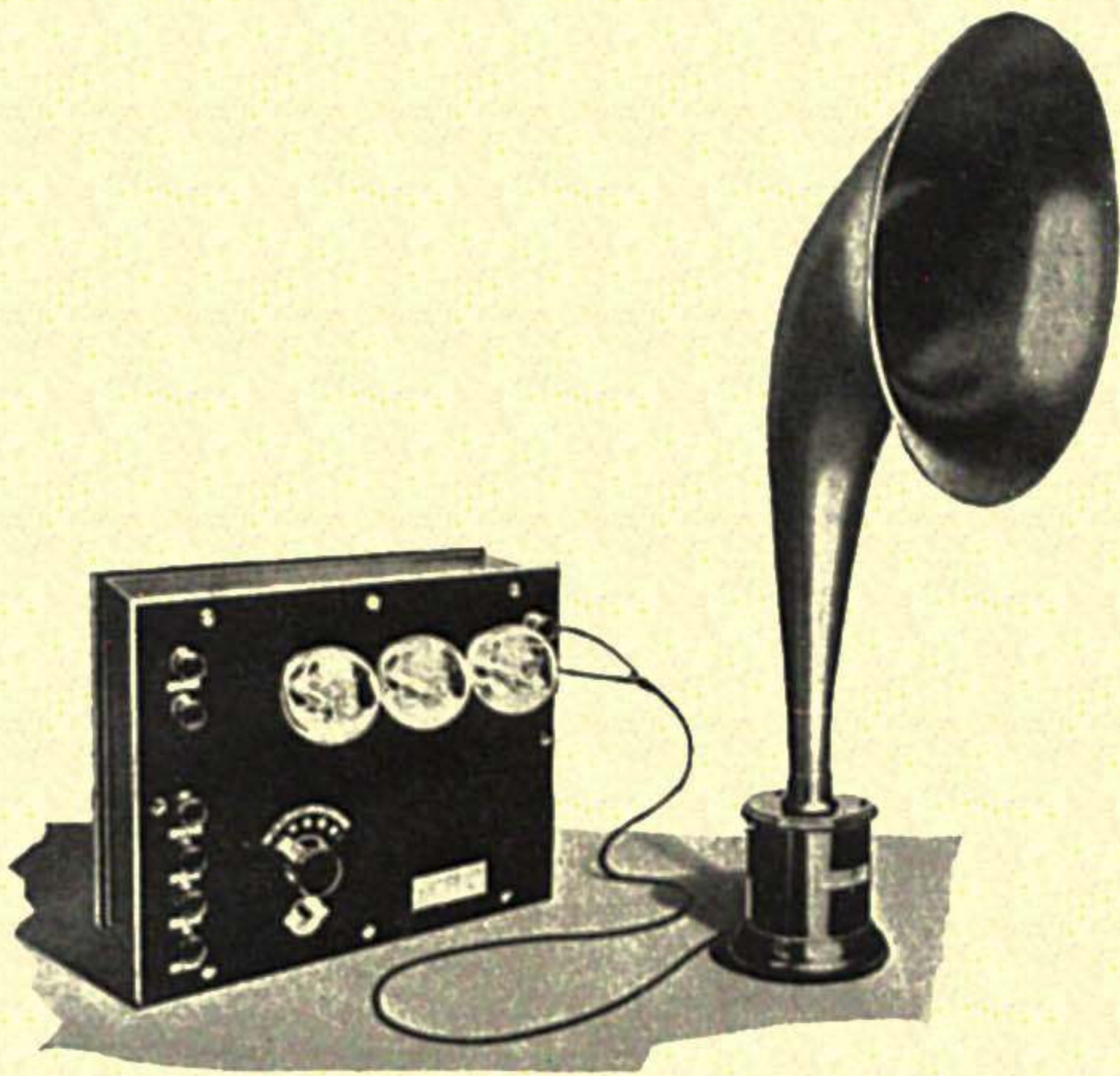

Fig. 78

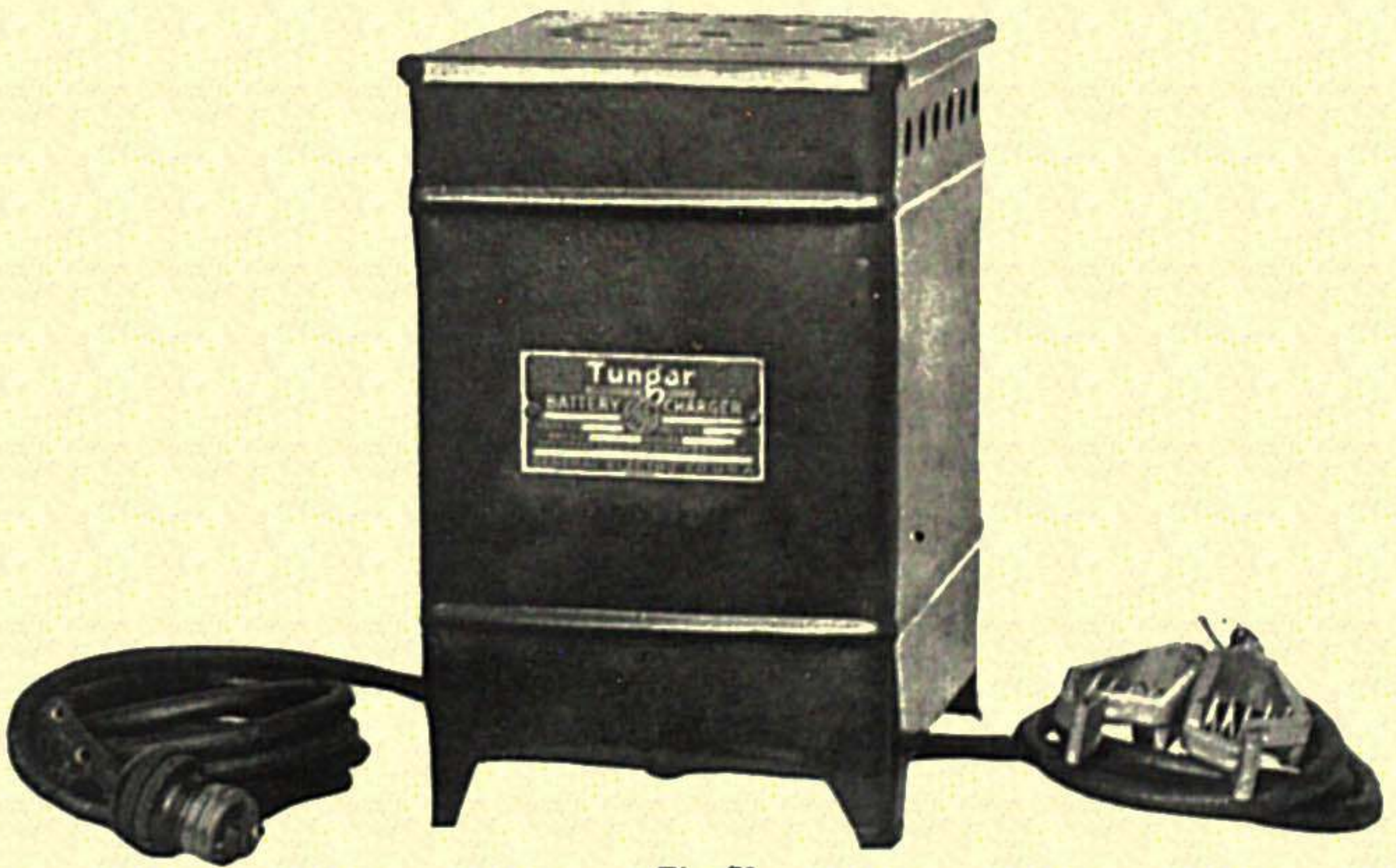

Fig. 79

SPECIFICATIONS STANDARD C-7

Item	Quantity		Price
1	1	Cabinet, Genuine African Mahogany, Dark Piano Finish, Removable Base, Hinged Top size 40 x 8 x 7 $\frac{3}{4}$ inches outside, made of $\frac{1}{2}$ inch stock.....	\$18.00
2	1	Panel, Genuine Grade M. Black Formica 40 x 8 x $\frac{1}{4}$ inches, cut square and smooth.....	9.90
3	1	Drilling Panel to Specifications.....	1.50
4	1	Engraving Panel to Specifications.....	6.00
5	8	General Radio Type 138 Y Binding Posts.....	1.20
6	1	General Radio Type 247V Special Condenser.....	4.75
7	1	General Radio Type 247K Special Condenser.....	4.00
8	1	.000045MF. Variable Vernier Condensers.....	1.50
9	1	Type C-7 Coupler as per Specifications.....	6.00
10	1	Type C-7 Output Transformer as per Specifications.....	6.00
11	2	EIS Model C-7 Rad. Fre. Transformers.....	17.00
12	2	General Radio 231A Audio Fre. Transformers.....	10.00
13	3	Eveready No. 746 Bias Batteries.....	1.20
14	1	.005MF Dubilier Type 601 Condensers.....	.75
15	2	.001MF Dubilier Type 601 Condensers.....	.90
16	1	Open Circuit Jack.....	.65
17	1	2 Megohm Grid Leak.....	.50
18	1	.00025MF Dubilier Type 601 Condenser.....	.35
19	1	Grid Leak Holder.....	.50
20	3	Western Electric 21K 1MF Condensers.....	6.00
21	7	General Radio Type 156 Sockets.....	7.00
22	60'	No. 12 Soft Drawn Tinned Copper Wire Round.....	1.20
23	60'	General Electric Insulating Tubing Black.....	3.60
24	1	C-H Filament Switch.....	.60
25	2	EIS 4-inch Dials with General Radio Knobs.....	3.00
26	1	Set Misc. Nuts and Screws.....	.25
27	1	Antenna Inductance as per Specifications.....	6.00
28	1	G. R. Rheostat 7 Ohm Type 214A.....	2.25
29	1	G. R. Rheostat 20 Ohm Type 214 A.....	2.25
30	2	Verniers	3.00
31	1	.01MF Dubilier Condenser.....	1.00
			\$126.85

EXTRA IF DESIRED

- 32 1 Set of Jewell Meters, consisting of a two-scale Voltmeter with five-point switch, reads A Battery Voltage, Detector Filament Voltage, Amplifier Filament Voltage and B Battery Voltage and a single scale ammeter. Panel drilled for meters at no extra charge. Price per pair, \$21.50

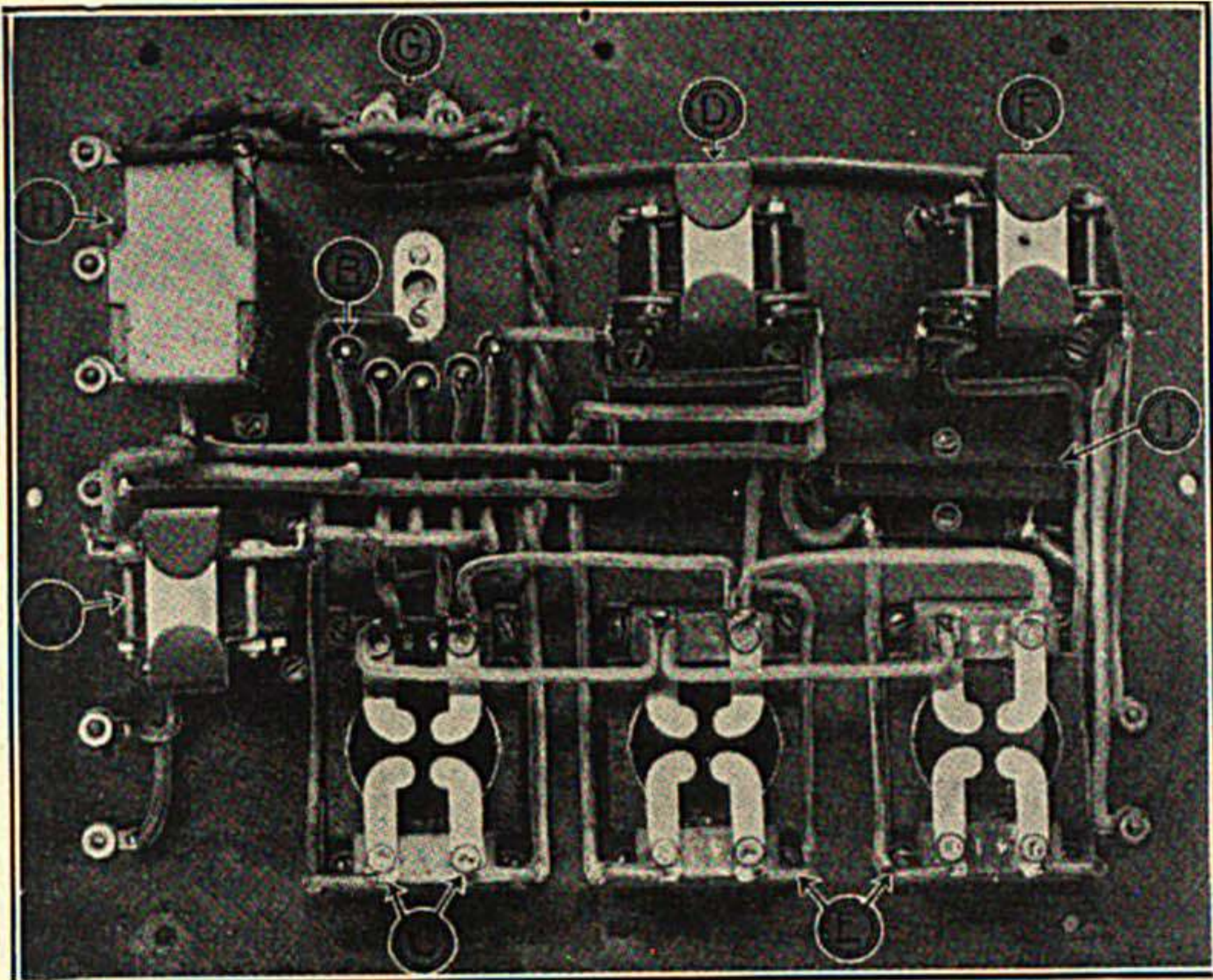

Fig. 80

Under Side of 7-A Amplifier Face Plate.
Western Electric 10-A Unit.

dyne through the amplifier immediately heterodyne again against the amplifier oscillations, giving an audible beat note. For best results on CW reception a separate oscillator should be set up to heterodyne with the amplifier oscillations. Such an oscillator should be in accordance with the details shown in Fig. 71. Inasmuch as the amplifier works at 30,000 cycles, the separate oscillator should be adjusted to 29,000 or 31,000 cycles for a 1,000 cycle note. However, with this direct close heterodyne it is found that the separate heterodyne oscillations are so strong that they paralyze the amplifier. Accordingly it is best to work on about the third harmonic of the amplifier wavelength. Referring to Fig. 71 it will be noted that this oscillator consists of two inductance coils and a variable condenser so that this circuit can be adjusted to the third harmonic of the amplifier wavelength. Once this oscillator is adjusted it can be left set permanently and remains in the one position regardless of the different wavelengths that are received in the usual manner on the Super-Heterodyne.

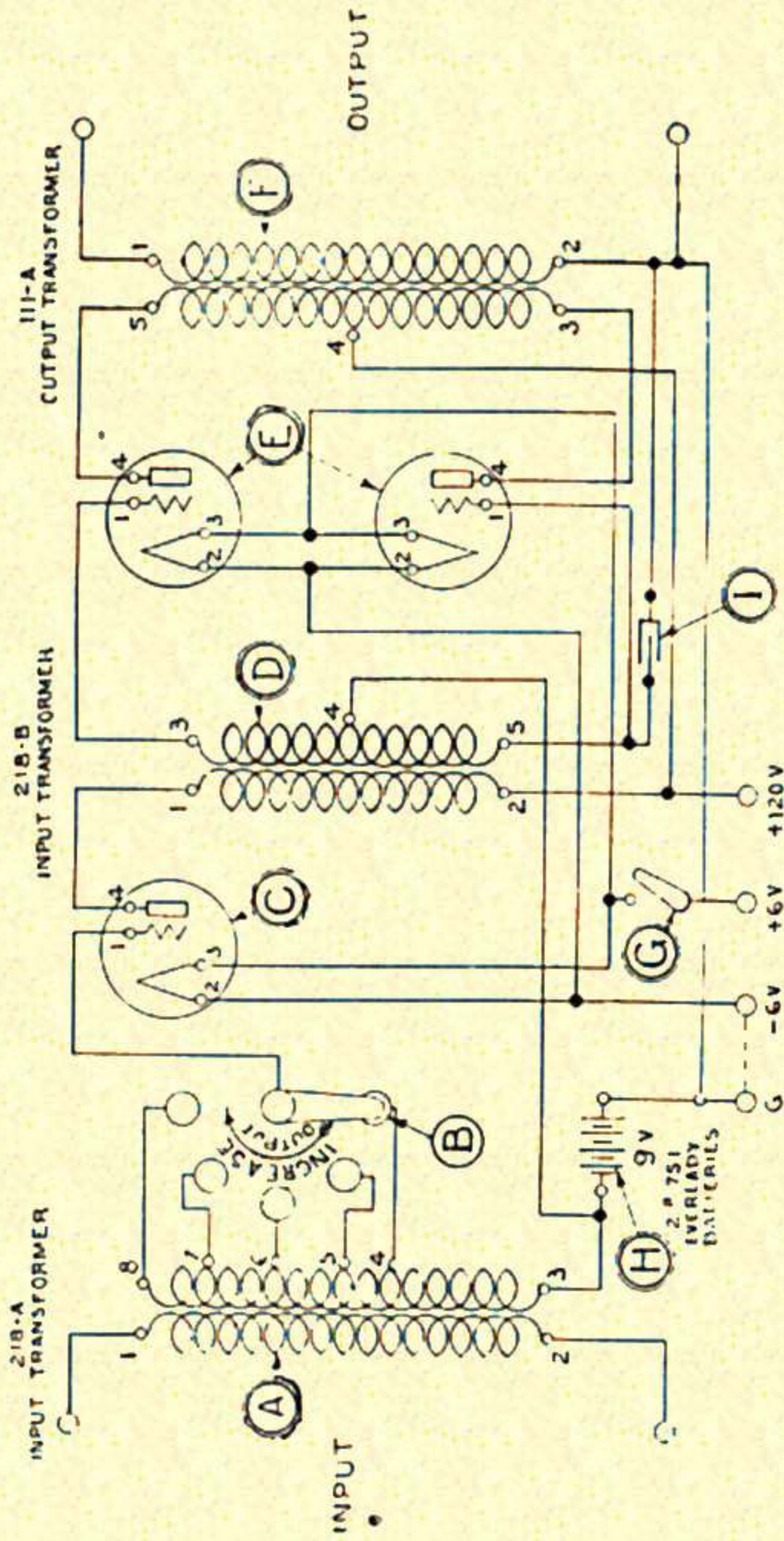
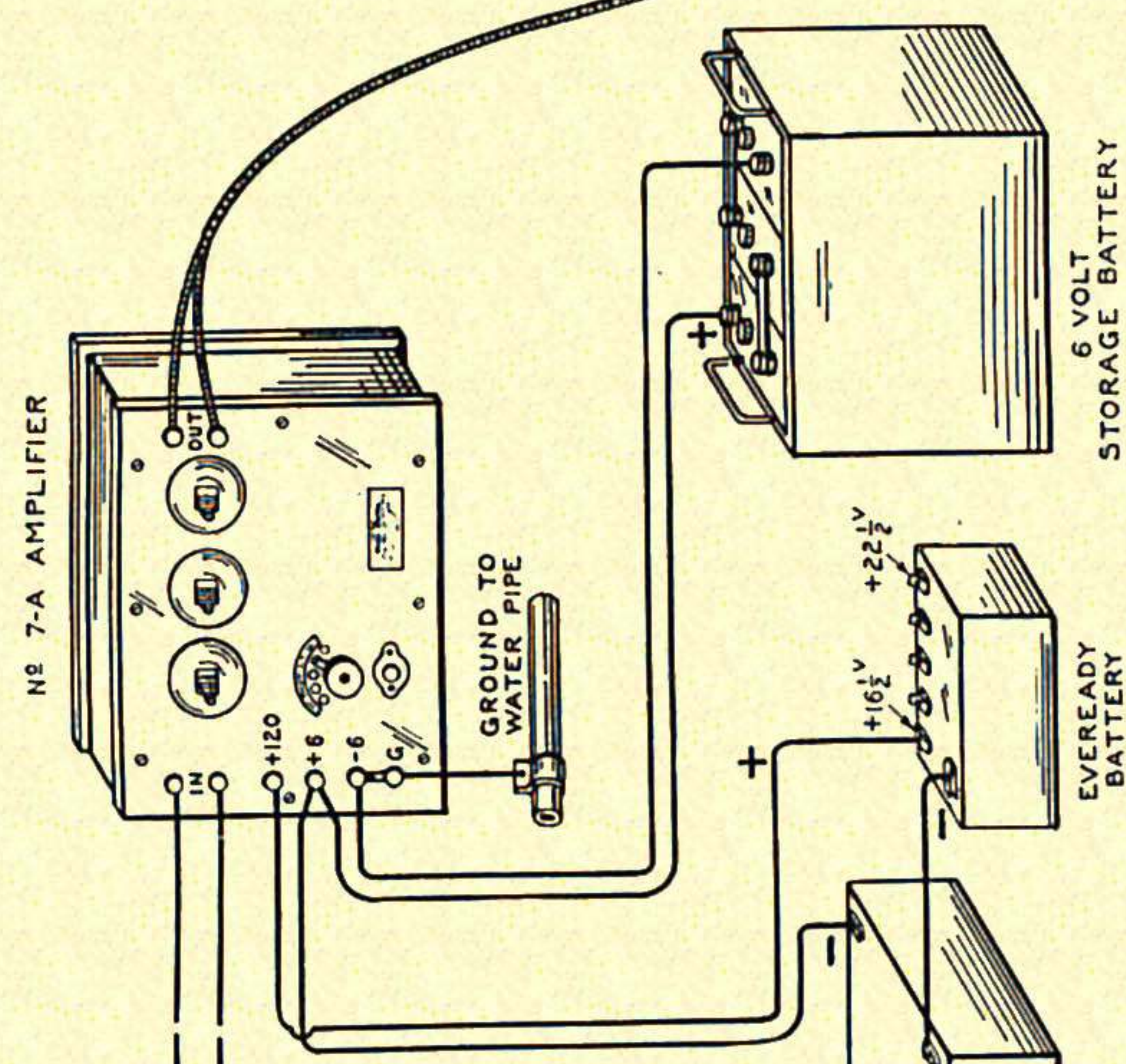
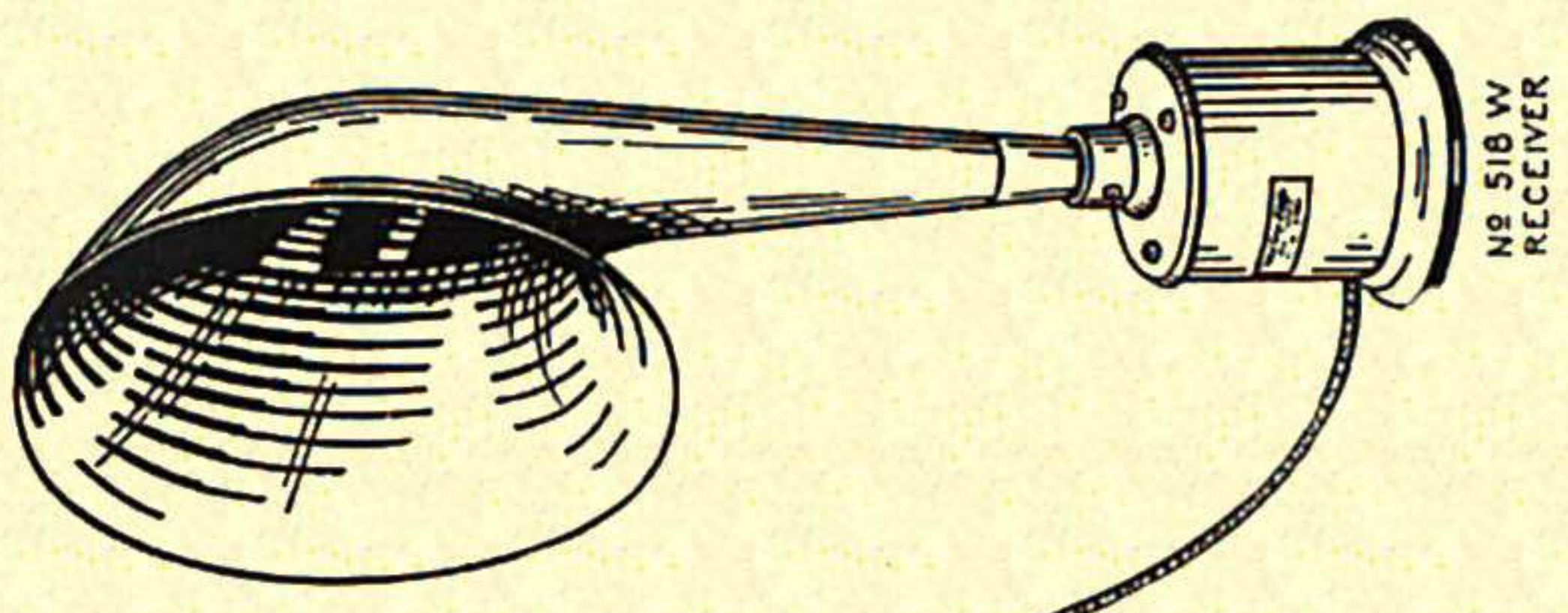

Fig. 81

CIRCUIT DIAGRAM—No. 7-A AMPLIFIER

- (A) Device for connecting the radio receiving set to the input circuit of the first amplifying tube in a manner which will prevent energy losses.
- (B) Multi-contact switch used for adjusting volume of sound in the receiver.
- (C) Vacuum Tube—Amplifies the voice currents delivered to it by (A) and (B).
- (D) Transformer used to step up the voltage of voice currents amplified by (C) so as to make them more suitable for operating (E).
- (E) Two vacuum tubes associated with a balanced circuit to enable them to handle a large amount of voice current energy without distortion.
- (F) Device for delivering energy from tubes (E) to the loud speaker with minimum loss and maximum efficiency.
- (G) Filament circuit switch.
- (H) Negative Grid Battery—Prevents Distortion
- (I) Condenser omitted in some models.



TO TERMINALS OF
RADIO RECEIVER
USUALLY EMPLOYED
FOR HEAD SET

NOTE

When No. 7-A amplifier and radio receiving set use same 6 volt battery and receiving set requires "+" terminal of battery to be grounded, omit ground on amplifier. Always connect "-6" and "G" on amplifier.

Fig. 82

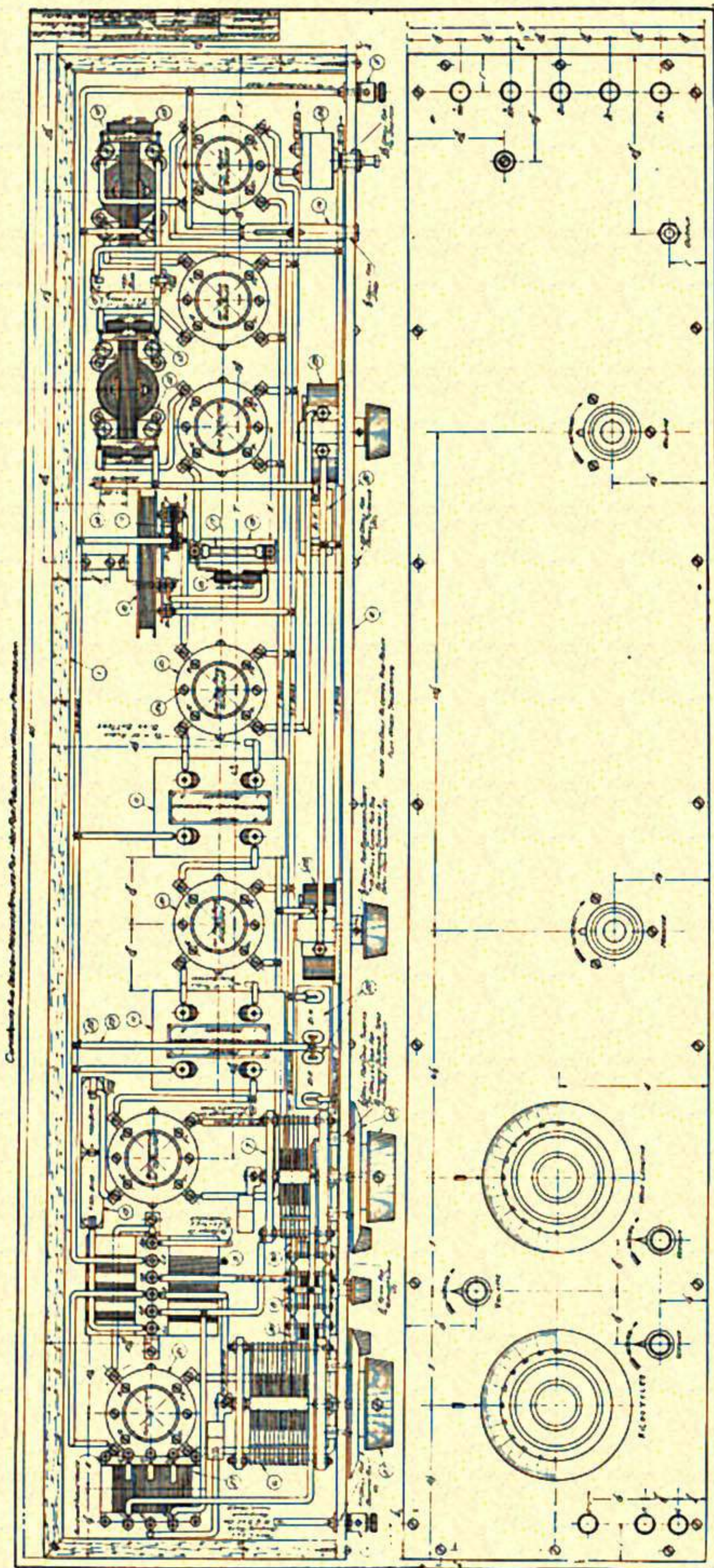

Fig. 83
 Assembly—Model C-7 Super-Heterodyne. (E. I. S. Drawing No. 3061.)

Copyright © 1935 by General Electric Company

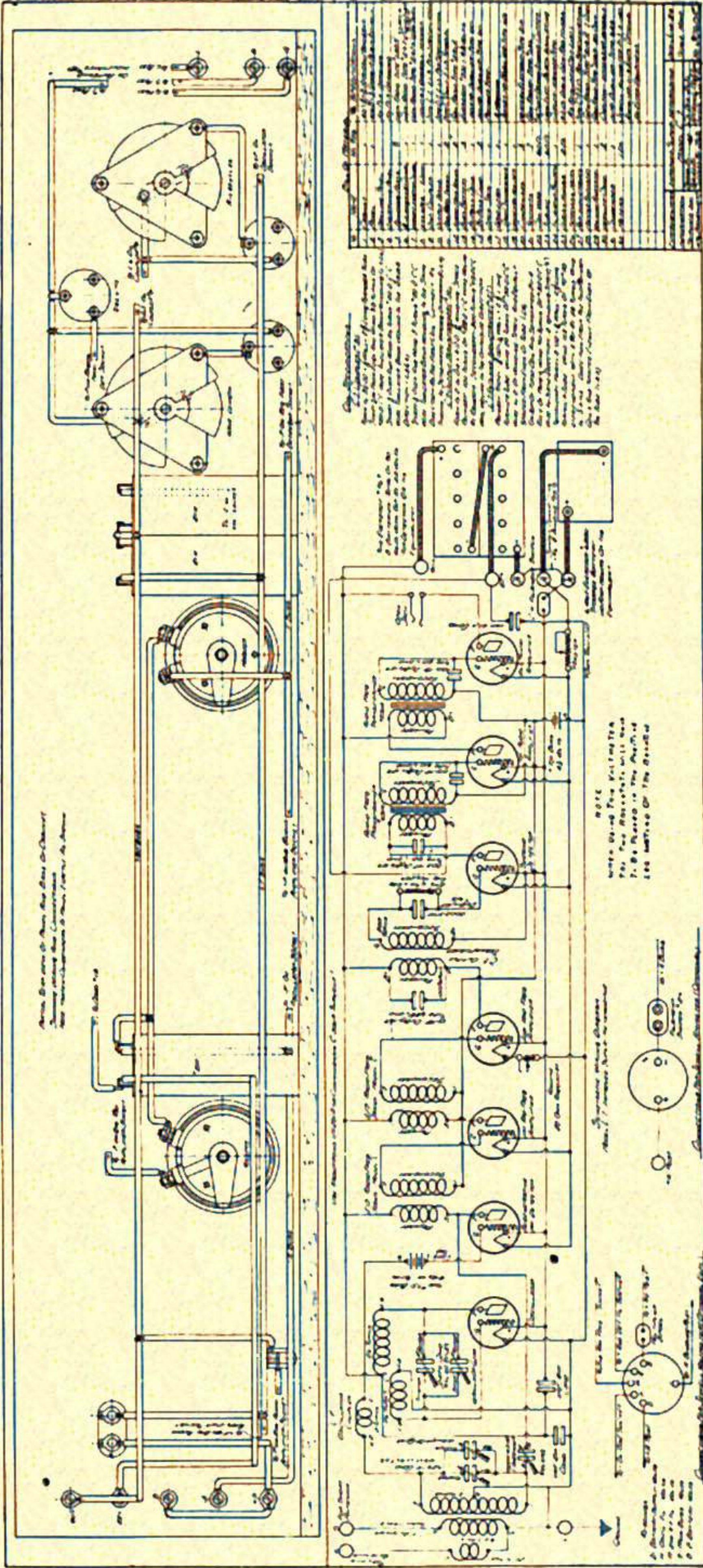

Fig. 83A
Rear View and Wiring Diagram, Model C-7 Super-Heterodyne (E.I.S. Drawing No. 3062).

A good method of setting for the initial adjustment is to tune the Super-Heterodyne to a 200-meter spark station first. Now that we know that the Super-Heterodyne is tuned to 200 meters the oscillator can be started and varied. It will be found that 200 meter CW signals will be heard on several positions of the external separate heterodyne variable condenser. This oscillator should be about six or eight feet from the amplifier. One of these positions on this variable condenser will be the most suitable and the condenser can be left at that setting. Incidentally, the received beat note caused by this separate oscillator can be varied from practically a 60-cycle note right up to inaudibility and the best note suited to the operators ear selected.

There is one difficulty when receiving CW signals and that consists of interference from long wave transoceanic stations working on about 10,000 meters. The amplifier is so sensitive that the small input coils pick up sufficient energy from these long wave stations to be amplified and heard if heterodyned. Ordinarily the interference from this source is not excessive. A good part of it can be eliminated by orienting the input coils (which are acting like a loop) until they are at right angles to the interfering wave, in which case they will be eliminated. A more effective method of eliminating extremely bad interference of this nature would consist of using astatically wound input coils. An astatically wound inductance consists of two windings opposing each other and the resultant inductance equaling that value desired. Astatic coils are not specified as standard equipment for this design as they would necessarily contain a very large amount of wire which would mean considerable resistance and as the distributed capacity would also be large this would sacrifice some of the desirable selectivity.

The entire amplifier half of this receiver is shielded with 14 ounce sheet copper. This includes the inside of the front panel and all the inside surfaces of the cabinet. The copper is cut away to insulate the jacks, binding posts, rheostat shafts potentiometer stabilizer shaft, etc., from making electrical contact with the copper.

When building one of these Model L Super-Heterodynes it must be remembered that patience and skill are required. No soldering acid must be used. All soldering must be done using a flux of alcohol and rosin. The wiring must be neat and all joints secure. The individual parts and circuit should be tested individually before trying the receiver as a Super-Heterodyne. The tubes must be tried in various locations and quite a number of tubes should be tried in each socket for best results at that point.

SUPER-HETERODYNE, ADMIRALTY MODEL "L"
 Do Not Depart From These Specifications by Substituting
 SPECIFICATIONS—List of Material Required

	Price
2 Cabinets, African Mahogany, Standard Finish	\$28.00
2 Panels, Grade M, Black Forajca, Plain	19.20
6 Dials and Knobs, 4" with 2½" Knobs	9.00
1 Stopping Condenser, .001 M. F. Dubilier, Type 601	.45
27 Binding Posts, G. R. Type, 138X	4.05
1 Ammeter, 0-5 Amps. D. C., Weston	8.00
1 Voltmeter, 0-10 Volts D. C., Weston	8.00
10 Rheostats, General Radio	22.50
2 Grid Leaks and Holders, Radio Corp., UP 523, UX 543	2.50
2 Grid Condensers, .00025 M. F. Dubilier, Type 601	.70
5 By Pass Condensers, .005 M. F. Dublier, Type 600	5.00
4 Variable Condensers, Spec. G. R. Type 239, with long shafts	54.00
5 R. F. Transformers, UV 1716, Radio Corp. or Model C	42.50
10 Sockets, G. R. Type 156	10.00
1 Oscillator Coupler, Special	6.00
2 Transformer Condensers, .00025 M. F. Dubilier 601	.70
1 R. F. Coupler, Special	8.50
1 R. F. Transformer Tuned, Special	8.50
1 180 Degree Coupler, Special	6.00
1 Special Condenser, .00027 M. F.	4.75
1 Primary Load Coil, Special	2.60
1 Secondary Load Coil, Special	2.25
5 Switches, 139A General Radio Type	4.75
1 Wave Change Switch, General Radio, 139A Special	2.10
33 Switch Contracts, General Radio Type, 138D	1.32
4 Closed Jacks, Premier Adjustable, No. 131	3.80
1 Open Jack, Premier Adjustable, No. 133	.65
1 Audio Transformer, General Radio	5.00
1 Potentiometer, General Radio	3.00
100 ft. Wire, No. 12 Soft Drawn Copper Tinned, Round	2.00
100 ft. Tubing No. 12 Black Impregnated Empire Tubing	11.00
Nuts and Screws, Miscellaneous	3.03
2 No. 751 Bias Batteries, 4½ Volts each, Eveready	.80
Shielding, 9 ft., 14 in. by 12 oz. Soft Drawn Copper	5.25
1 IMF Condenser 21K., W. E. Co.	2.00
EXTRAS	
Milliammeter 0-100, Weston	9.00
0-100 Voltmeter, Weston	13.00
Panel Drilling, Labor	4.00
Engraving and Graining Panels, Labor	18.20

Fig. 72 shows a pictured drawing of the model L with notations for the various tuning and amplifier setting adjustments. However, instructions are only a preliminary assistance and careful observation and practice are necessary to enable one to secure the results that this receiver is capable of giving.

The experimental results obtained with Super-Heterodyne receivers in various locations and under a variety of different conditions are very interesting. In New York City proper the conditions are most adverse, due of course principally to the large amount of steel in the large buildings. Tests made indicate that many of these buildings deflect or absorb energy from certain stations more than from other stations, depending upon the wavelengths of the stations. For example, one man located in a suite in the Great Northern Hotel, New York, was unable to receive station WEAF. Several standard regenerative receivers were tried without success. One receiver did receive from this station but without a reasonable amount of volume. A Model C with a standard Radio Corporation Loop was tried and the result was that plenty of audibility could be obtained from WEAF or any of the other local stations. The loop, however, lost all of its directional qualities. Philadelphia stations WIP and WOO, each having a wavelength slightly higher than WEAF, were also copied very readily without difficulty in daylight. The answer is the large amount of radio frequency amplification available in this Model C Super-Heterodyne and the feature of uniform amplification over the entire wavelength range.

The upper section of Riverside Drive in New York is undoubtedly one of the most favorable locations in the east for long distance reception from the south and west. A location at the foot of West 180th St. was ideal. Using a Radio Corp. Loop and only a simple regenerative detector and one stage of audio amplification, stations such as WHB Kansas City, WOC Davenport, KYW Chicago, CKAC Montreal, CFCA Toronto, and other stations within 1,500 miles were copied nightly during the winter, just with these two tubes and a loop. There was nothing freakish about this performance at all and no re-radiation effect as the operator could change from one station to another right up the scale.

Now, when a Model C Super-Heterodyne was installed at this most favorable condition the reader can well imagine the signal strength from a distant station. Regardless of the local station, 15 or 20 different distant stations could be selected in less than two hours, and each one strong enough to be heard all over the apartment with a 10-D Loud Speaker. Omaha was just as strong as Pittsburgh and Denver.

was just as loud as Chicago. The Mercantile Trust Co. station in San Francisco KFDB, the Los Angeles Times-Mirror KFI and Portland Oregonian KGW were received with almost the same audibility as the various Chicago stations. This indicates the decided advantage of a good location as all of the above results were obtained with a loop. In other sections of New York City it is almost impossible to receive the west coast stations even with an antenna.

Many people have claimed to have heard the English broadcasting stations and this is very questionable. Due to the difference in time it would be necessary on the eastern coast of the United States to listen between three and six o'clock in the afternoon which is, of course, daylight. To receive three thousand miles in daylight from a low power broadcaster would be quite remarkable and would require more than a sensitive receiver. Any one that has claimed to have heard the English stations would have a receiver capable of receiving Chicago in the daytime and the writer has never seen this demonstrated.

It must be remembered that a powerful receiver not only amplifies the weak desired signal, but also amplifies the static and interfering signals. If the station desired does not have a signal strength greater than the static and interference, it is useless to carry on amplification as the static and interference will always be stronger than the desired signal.

If the English stations broadcasted at a time corresponding to night time both in London and New York, it would simplify conditions and undoubtedly the English stations would be received nicely, as the transmission is over water, a decided advantage. The only disadvantage would be the interference from American Broadcasting stations on wavelengths close to the wavelength of the English stations.

Around the Pittsburgh section, with a powerful receiver such as the Model C, the west coast stations are readily copied. Furthermore, 40 miles west of Pittsburgh at Steubenville, Ohio, reception from the New York stations about 400 miles was easily accomplished in the daytime. However, in New York City it is quite difficult to receive the Pittsburgh stations in the daytime, until around seven o'clock at night. During the summer, the signals received from KDKA are about three times as loud at ten o'clock as they are at seven o'clock.

During the summer months it is necessary in the east to wait until ten o'clock before expecting reception from Chicago. Due to time difference, one hour between eastern and central time and one hour due to daylight saving time, ten o'clock in the east is eight P. M.

in Chicago and it is just about sundown. 10 P. M. in Chicago is midnight in the east and then signals start to come through in good shape. On the West Coast the broadcast listeners have a still more difficult proposition as there is four hours difference counting daylight saving time. The New York stations stop transmitting at 11 P. M. and for a West Coast listener to receive them he would have to accomplish this about 7 o'clock in the evening, and of course there is little chance.

The Super-Heterodyne is of considerable value on the West Coast as it enables distant reception while their local stations are transmitting. If there, their receiver will not eliminate local reception and they have to wait for the local stations to stop, they then find that all other stations in the country have also stopped. To surmount this difficulty they have "quiet" nights so that the listeners can search for the distant stations. Quiet nights in the east would enable West Coast reception with only a high grade regenerative receiver plus one or two stages of tuned radio frequency amplification during cold weather.

The use of a Super Heterodyne from shipboard resulted in excellent results. This is partially due to the lack of local interference and the advantage of over water reception.

In February, 1923, Dr. Horatio Belt installed a Super-Heterodyne in his cabin on the S. S. Western World bound from New York to Rio de Janiero, Brazil, an eleven-day trip. When 2,700 miles southeast of New York, various stations, such as Boston, Schenectady, New York, Newark, Pittsburgh, Louisville, Kansas City, etc., were received with very strong volume. At 3,000 miles southeast of New York, the entire Greb-Gardner fight was copied from WJZ at Newark, blow by blow, and with sufficient audibility for a dozen people to listen in.

At a distance of 3,300 miles southeast of New York, the entire Sunday evening church service was received from KDKA East Pittsburgh. At greater distances the static increased so fast that further reception was impossible. It was Dr. Belt's opinion that reliable reception from American broadcasters could be obtained from Rio de Janiero during their dry season. The regulations there prevented Dr. Belt from using the receiver in Rio de Janiero.

Another gentleman by the name of Mr. A. Ancieux recently left with a Model C installed in the cabin of the S. S. Santa Elisa bound from New York to Peru. Advice from him stated that reliable loop reception was obtained up to the time the steamer reached the Panama Canal and undoubtedly further advice will describe record-breaking

distances as his location will be over 5,000 miles from New York and located in a very cold section of the South American continent.

Other parties are completing arrangements to use the Model C in New Zealand, Shanghai, China, Cape Town, Constantinople, London and several other distant points and their results will certainly be of considerable interest and value.

Mr. F. R. Meginness, of Albany, is one of the earlier experimenters with the Super-Heterodyne Receivers, starting back with a resistance coupled set. The resistance coupled type is very nice but the amplification is low, always less than the tube amplification constant, for example, about 6 per stage. With a transformer coupled type the amplification is equal to the tube constant times the transformer ratio, if the transformer is of correct design, or 18 per stage. Cube this for three stages for each type and it shows an enormous difference and this difference is actually obtained. At Mr. Meguiniss' station, signals from KSD on a 10 tube transformer coupled Super-Heterodyne are at least 10 times the audibility as that obtained with the old 10 tube resistance coupled set.

Two stages direct tuned radio frequency amplification have been added to this equipment in front of the 1st detector and this has resulted in a considerable increase in volume obtained from distant stations. Broadcasters at Chicago, St. Louis, Kansas City, Davenport, Omaha, Havana, etc., are received with sufficient audibility to be heard several blocks. This receiver is calibrated for practically all stations and it is possible to change from one to another instantly and receive almost all of them equally well. Albany is only 17 miles from the powerful Schenectady (WGY) station, yet WGY does not interfere with distance reception in the least.

Ships are not supposed to transmit on 450 meters before 10:30 at night. After 10:30 P. M. many ships transmit on 300, 450 and 600 meters.

When a ship transmits on 450 meters and the transmitter is "broadly" tuned, it actually transmits on all wavelengths from, say, 400 to 500 meters. Accordingly, if a sensitive receiver is adjusted to receive station WJZ on 455 meters and a ship is transmitting on 450 meters it is obvious that the ship's telegraph signals will seriously interfere with the broadcast reception. This is a difficulty that is due to the small range of wavelengths available and wavetraps and changes in receiver design will not correct this condition.

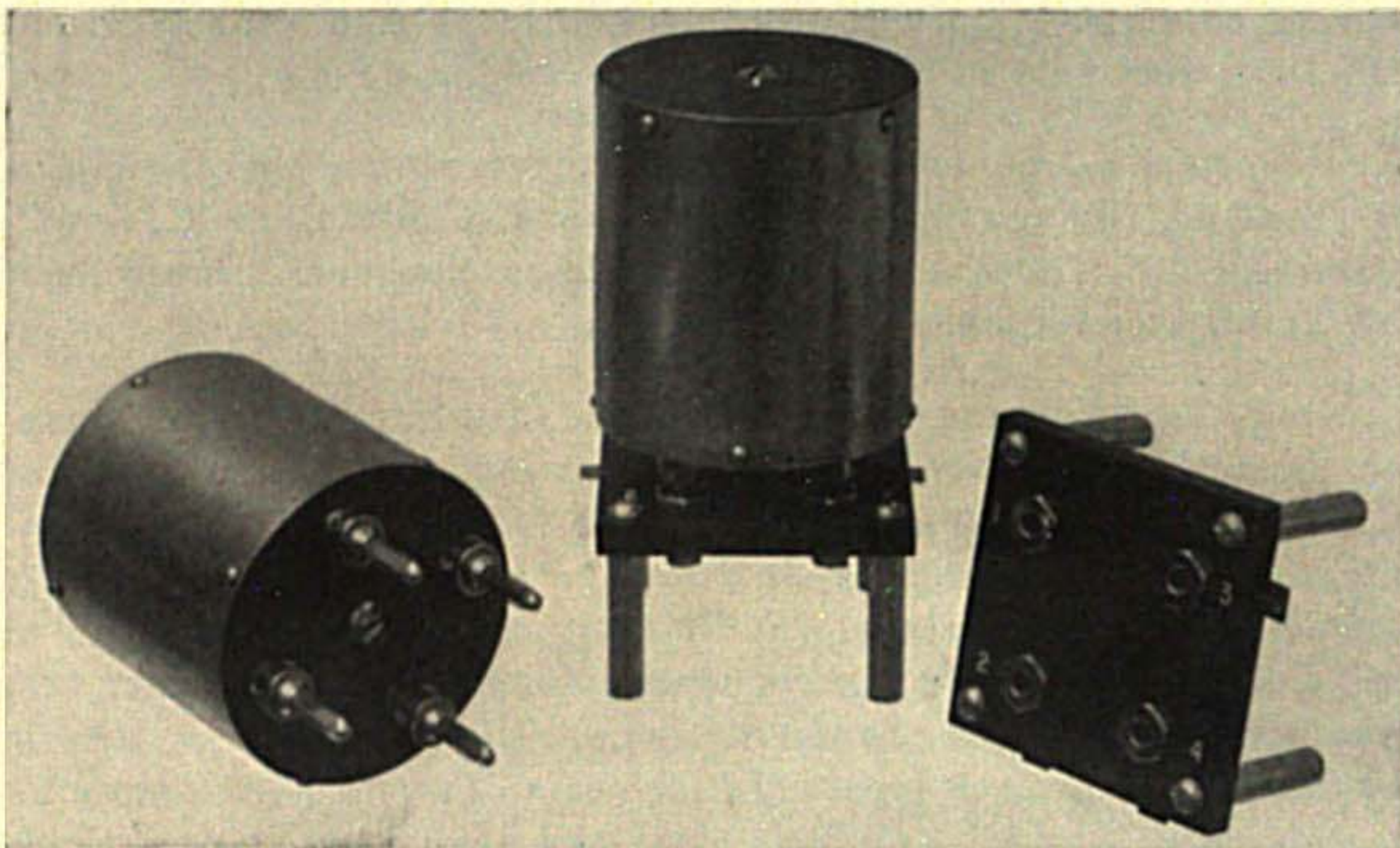

Fig. 84

Type C-7 Radio Frequency Transformers.

The design of a highly efficient Radio Frequency Transformer for the intermediate amplifier of a Super-Heterodyne is a difficult proposition. The transformer must have a sharply defined operating peak, without being so sharp as to cause distortion by destroying part of the impulses amplified. It is found by actual experiments covering a period of three years that best amplification is obtained at approximately 47,000 cycles and it is also found that an iron core transformer gives by far the best results.

To convince the writer that air core transformers were not better than the iron core type, he had Pacent make some special Duo-Lateral Honey Comb Coils wound with a conductor consisting of three twisted cables, each cable consisting of 16 strands of No. 38 enamel wire. This is standard Navy Litzendraht and provided an inductance of the lowest possible resistance at that frequency. The coils were about 7 inches in diameter. Transformers constructed of such inductances did not give any better results than obtained with the Model C or C-7 Radio Frequency Transformers which have an iron core. The core consists of special thin laminations. The core is properly balanced so that the audio amplifying properties of the transformer are very small. There are several radio frequency transformers on the market now which have cores as big or almost as big as audio transformers. Such transformers amplify at both radio and audio frequencies and the disturbances from such an amplifier are terrific.

The new Type C-7 Radio Frequency Transformer is recognized as the best transformer available for Super-Heterodyne amplifiers. This new type is supplied with plug terminals and socket. This construction allows rapid test work to match⁴ in pairs in actual receivers.

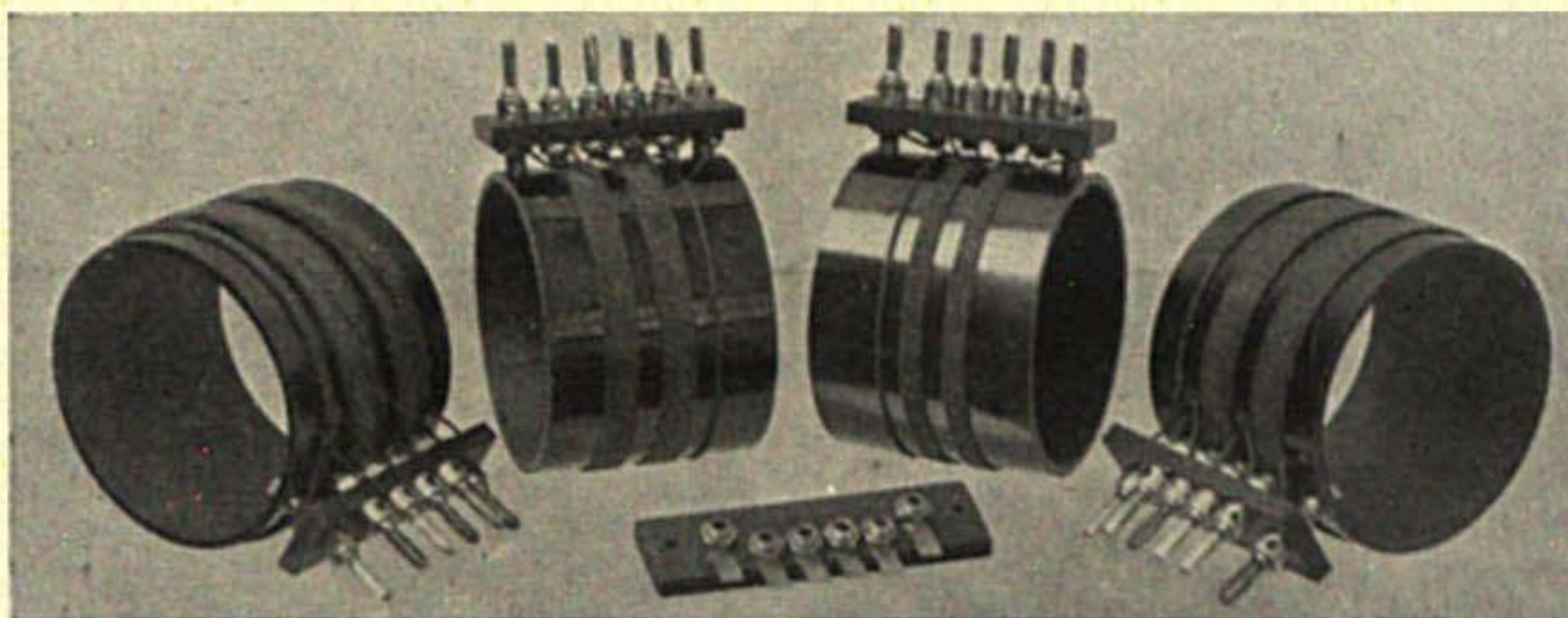

Fig. 85

Interchangeable Oscillator Couplers to allow low wavelength reception. There are seven sizes, allowing reception from 1,500 meters down to approximately 50 meters.

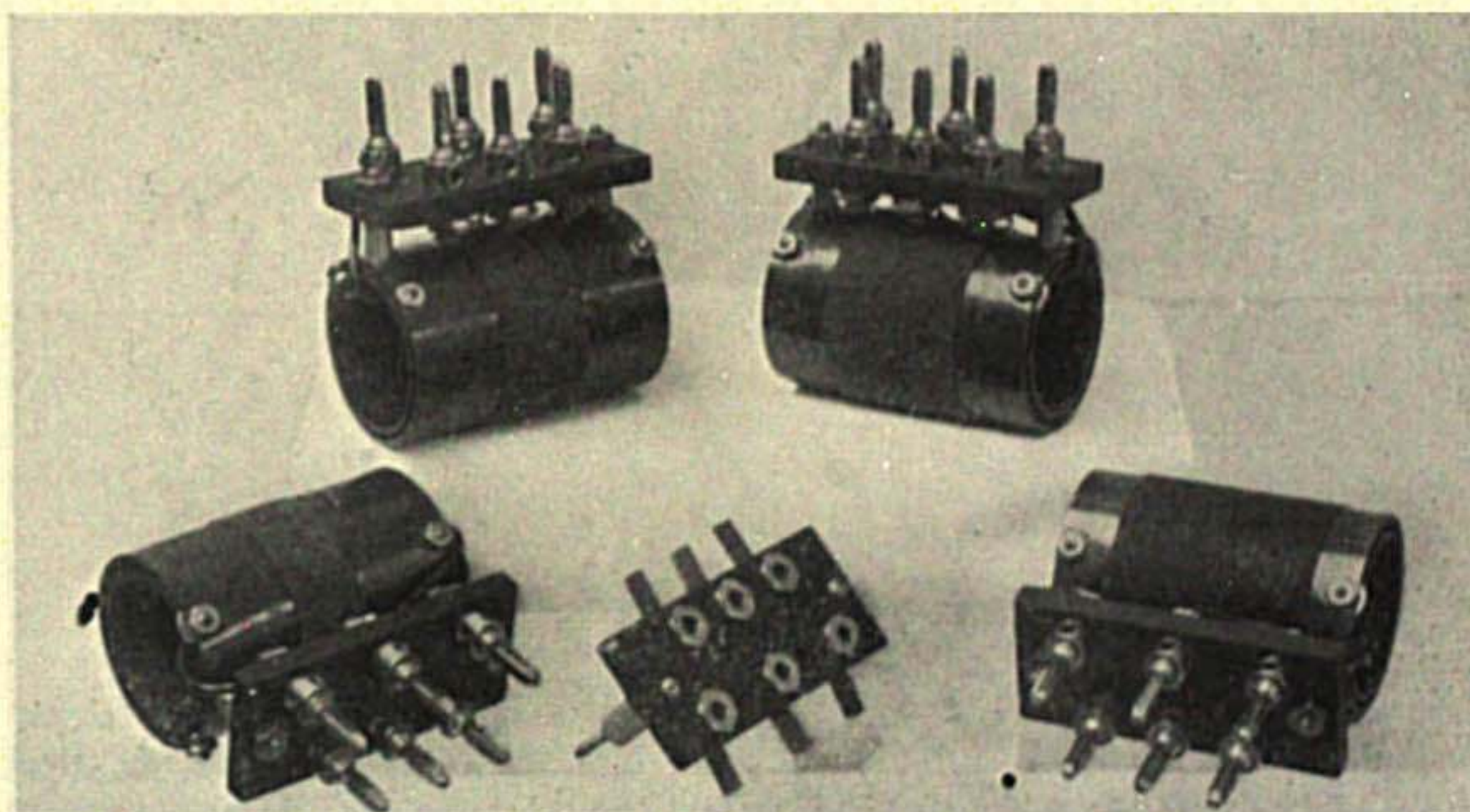

Fig. 86

Interchangeable Antenna Inductances to allow low wavelength reception. There are seven sizes, allowing reception from 1,500 meters down to approximately 50 meters.



Fig. 87

OPERATING CONTROL TABLE FOR MODEL C-7.

Special Control Table designed by Mr. F. R. Meginness of Albany, N. Y., for a C-7. Facilities are provided to enable any desired voltage combinations for the amplifiers, detector or power amplifier circuits, and relative merits of two receivers can readily be determined. An automatic battery charging system is included in the design. Switching arrangements are available for distributing the output to any external points required. The Loud Speaker combination consists of a Phonetron and a Western Electric 10-A Power Amplifier and Horn.

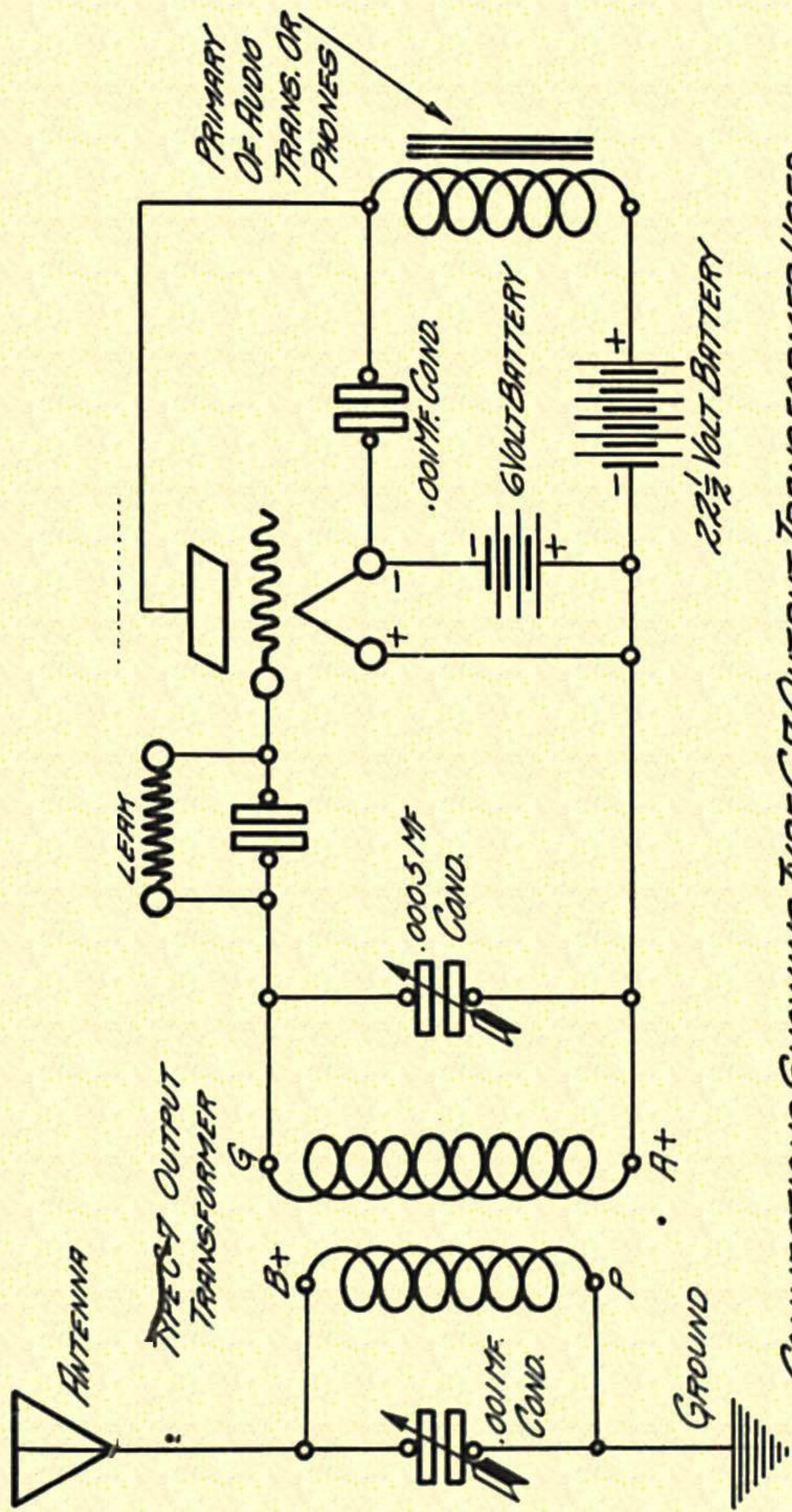

CONNECTIONS SHOWING TYPE C-7 OUTPUT TRANSFORMER USED AS A RECEIVER FOR HARLINGTON TIME SIGNALS AND OTHER DAMPED SIGNALS OF 1000 TO 3000 METERS, WAVELENGTH.

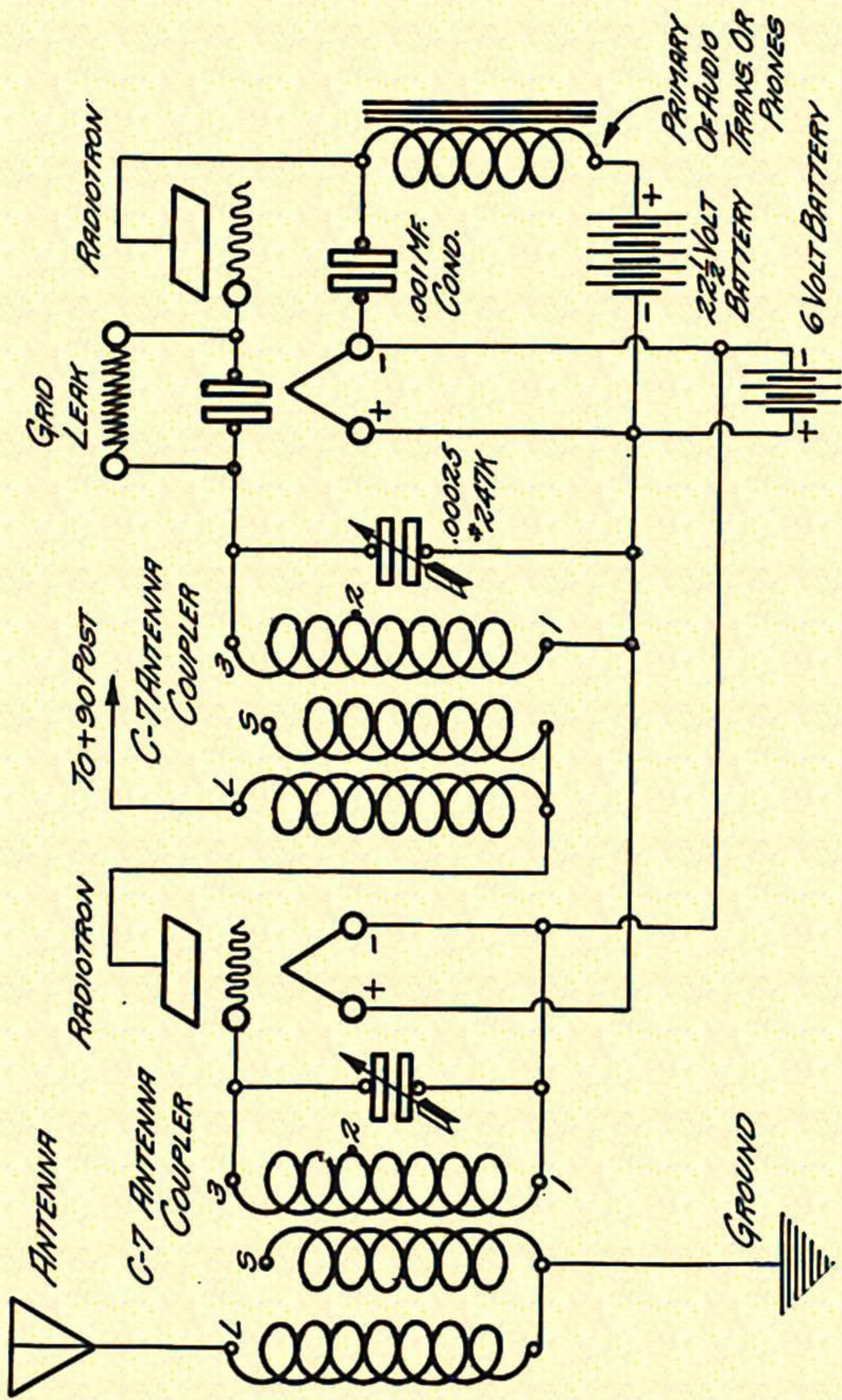

CONNECTIONS SHOWING TYPE C-7 ANTENNA-COUPLER, USED AS A TUNED RADIO FREQ. TRANSFORMER.

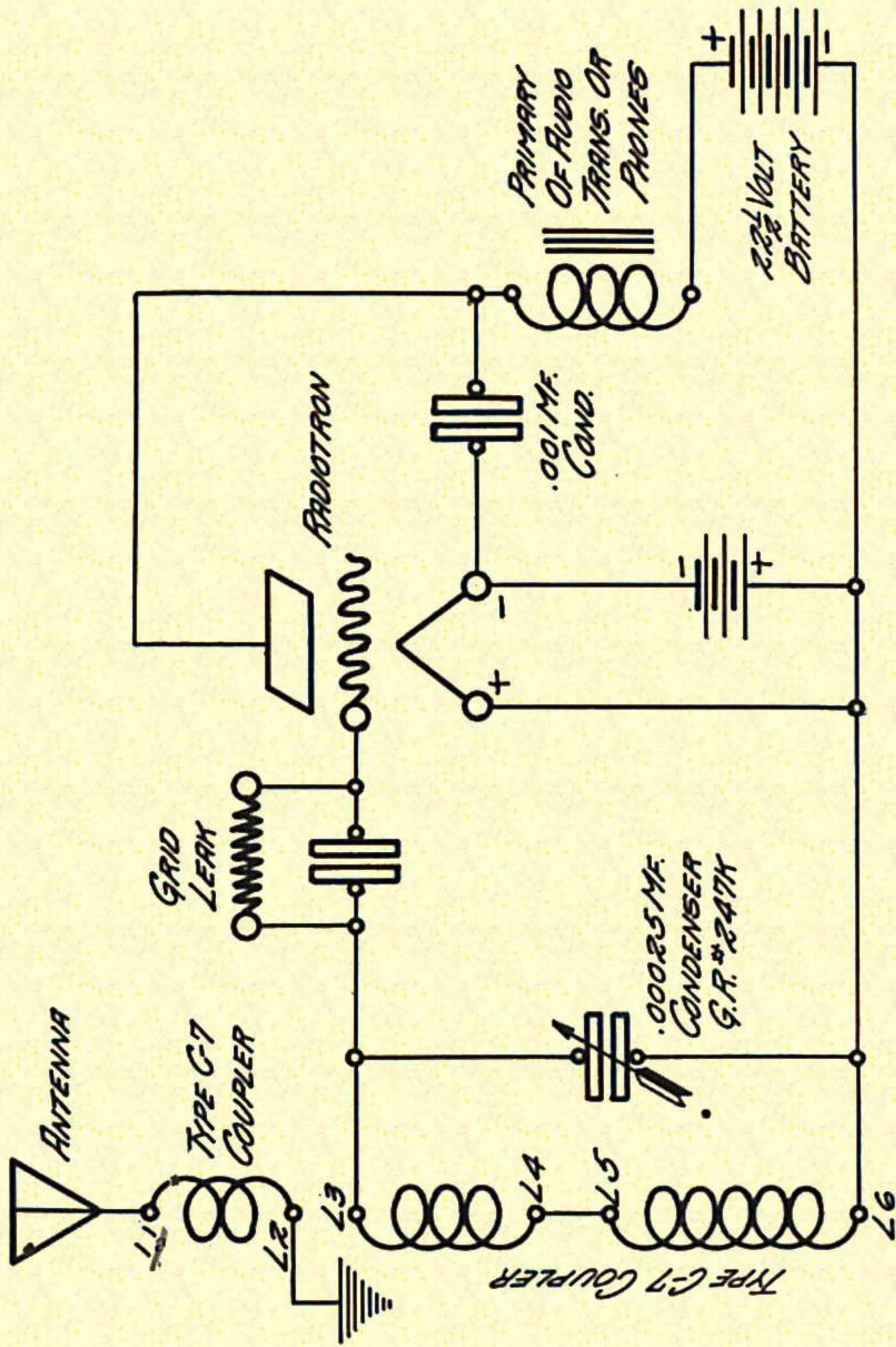

CONNECTIONS SHOWING TYPE C-7 COUPLER USED AS AN UNTUNED ANTENNA ADAPTER FOR ANY LOOP RECEIVER.

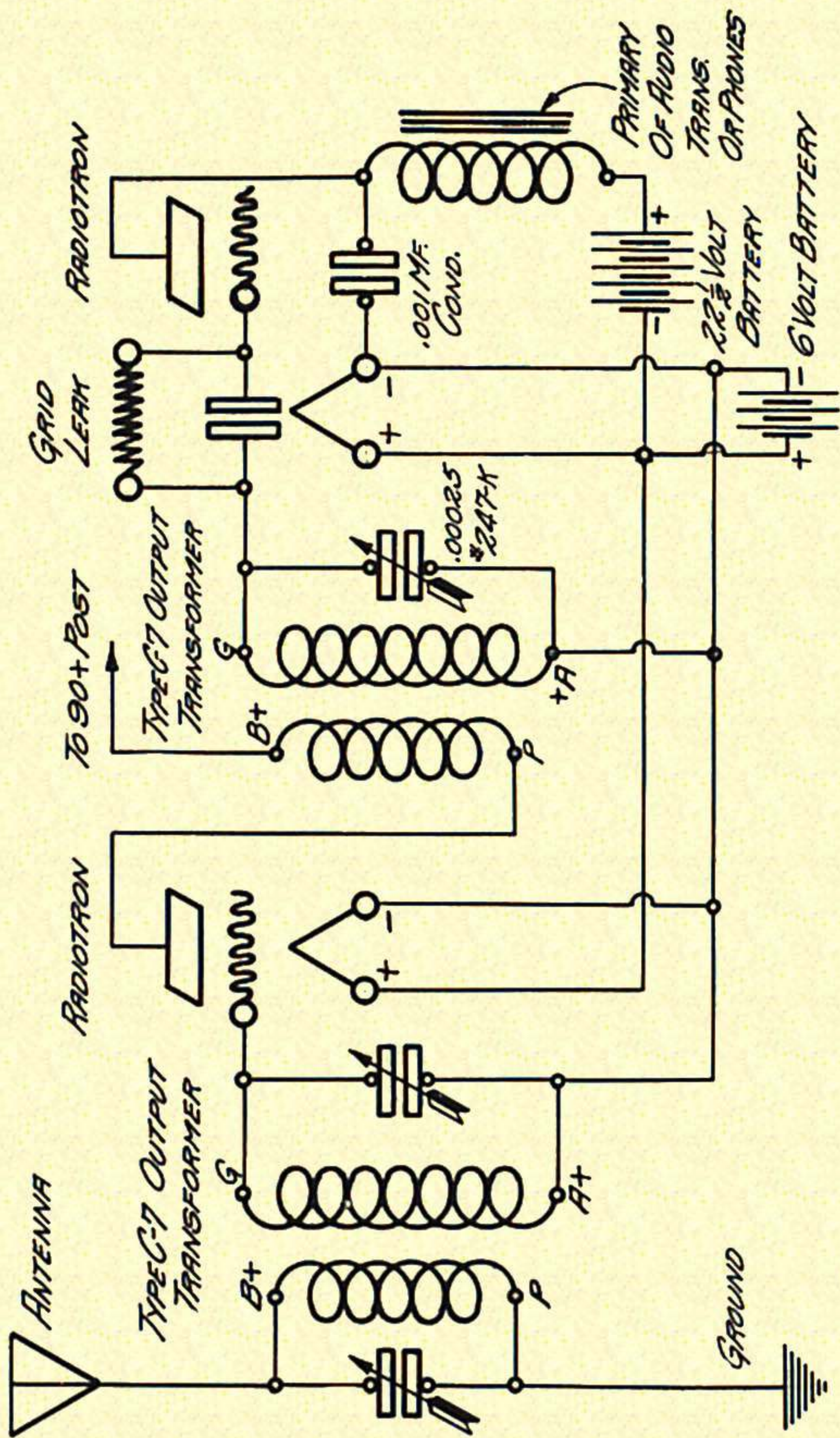

CONNECTIONS FOR ARLINGTON TIME SIGNALS, USING TYPE C-7 OUTPUT TRANSFORMER AS AN ANTENNA COUPLER AND A SECOND C-7 TRANS. AS A TUNED RADIO FREQUENCY TRANSFORMER.

Fig. 91

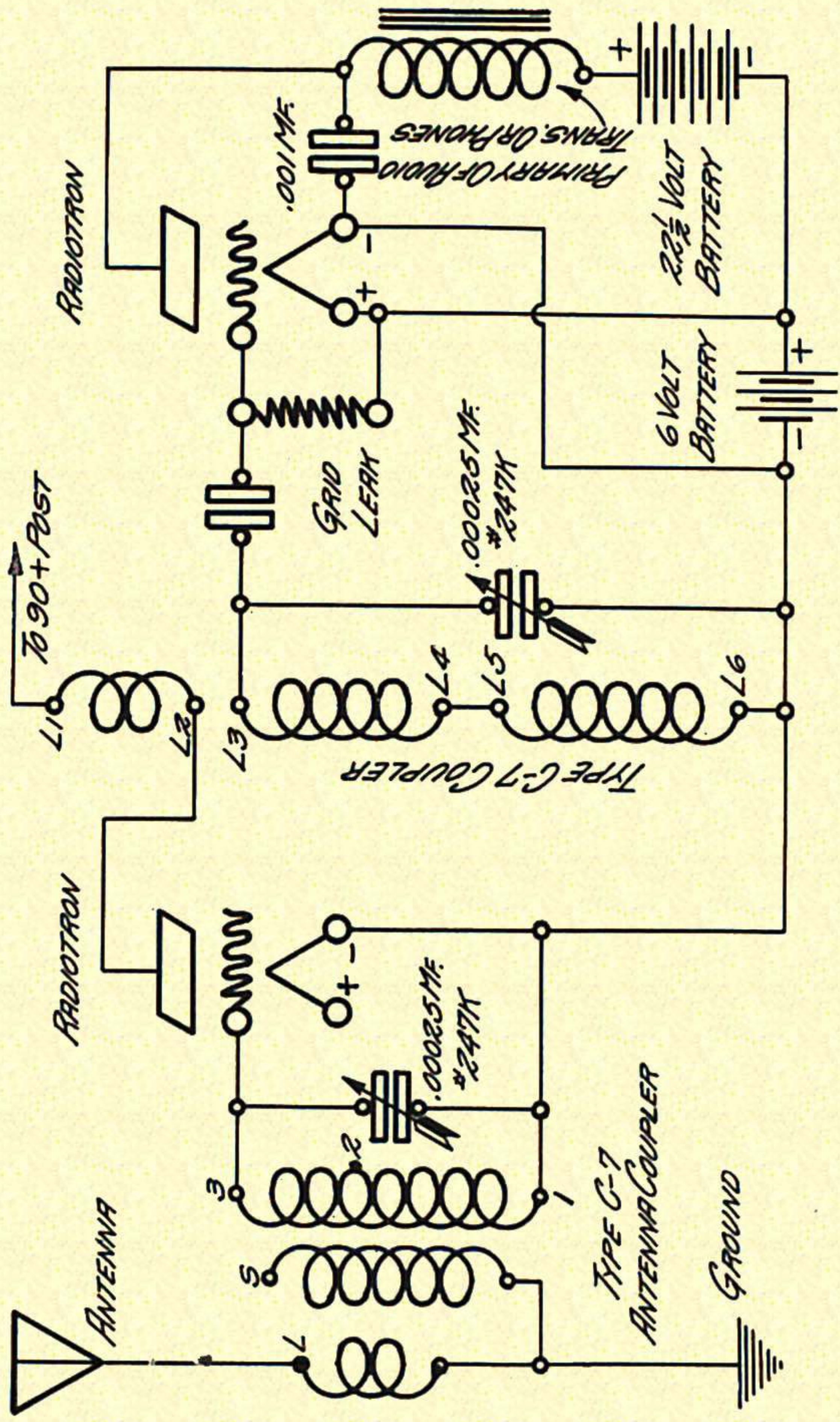

CONNECTIONS SHOWING TYPE C-7 ANTENNA COUPLER USED AS A TUNED RADIO FREQUENCY TRANSFORMER.

Fig. 92

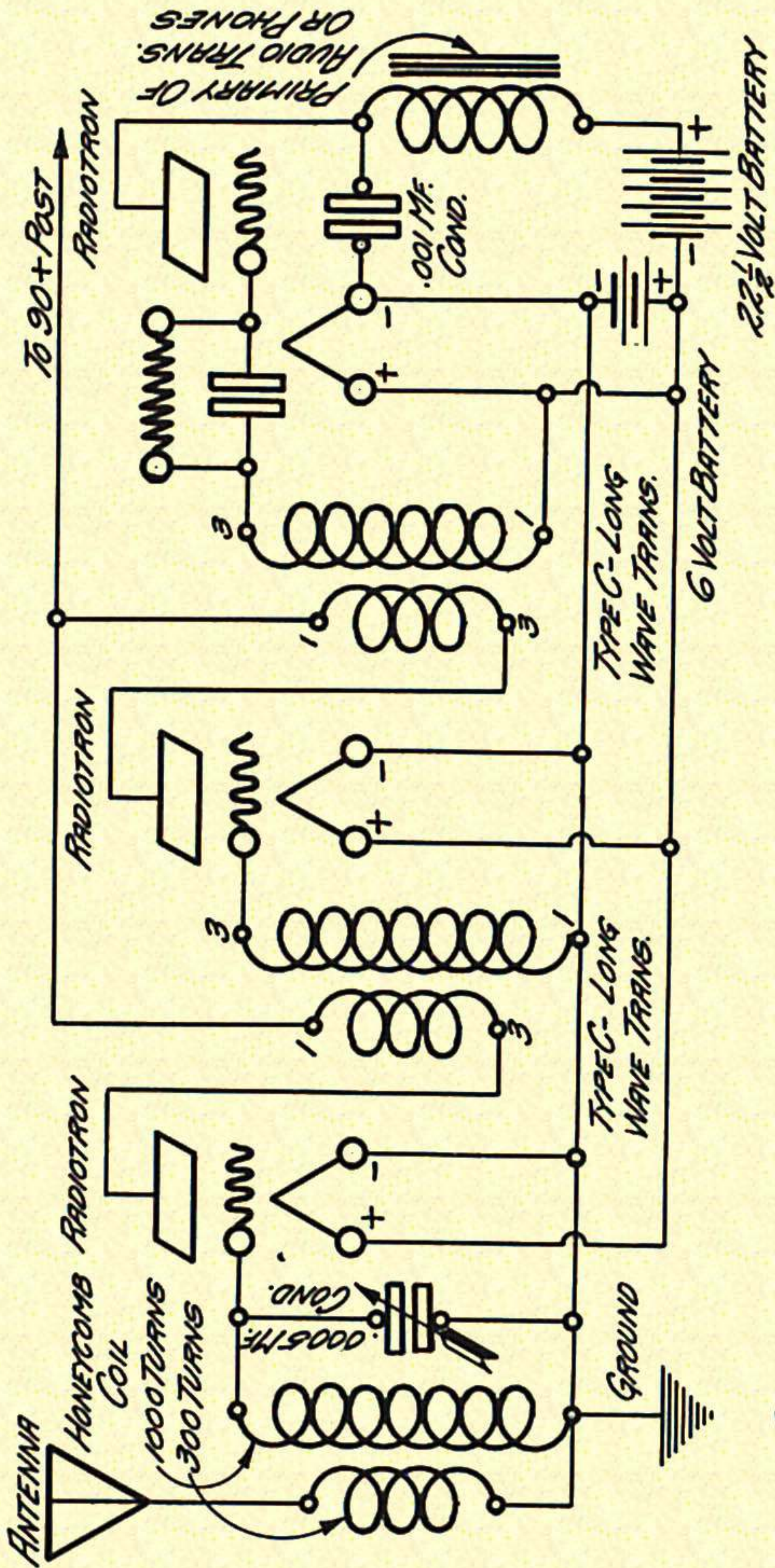

CONNECTIONS OF TYPE C-LONG WAVE RADIO FREQUENCY TRANSFORMER FOR LONG WAVE RECEPTION, 5000 TO 15,000 METERS-DAMPED WAVES.

Fig. 93

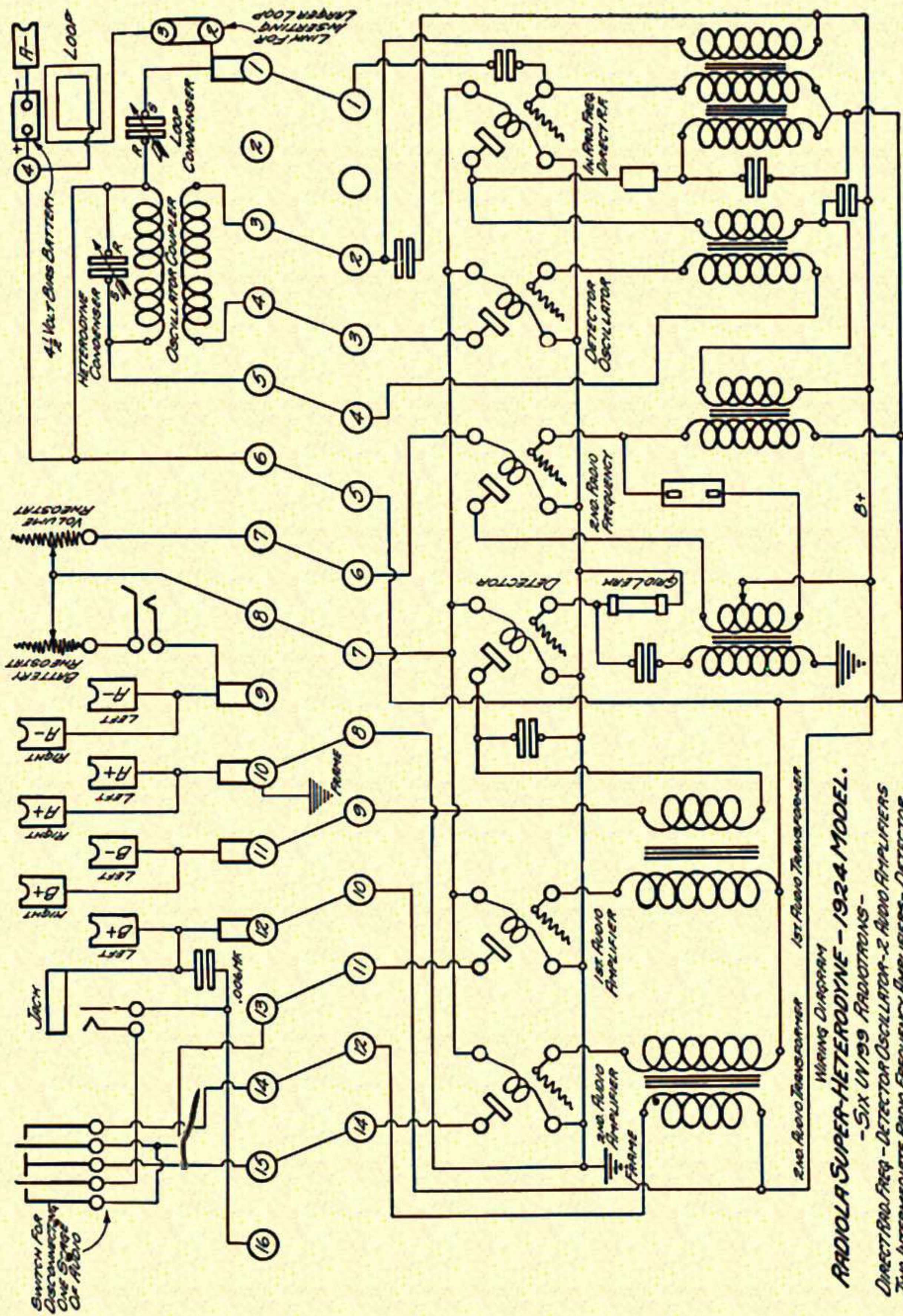

Fig. 94

RADIOLA SUPER-HETERODYNE - 1924 MODEL.
 WIRING DIAGRAM
 -SIX UN/99 RADIODIONS -
 DIRECT RAD. FREQ. - DETECTOR OSCILLATOR - 2 AUDIO AMPLIFIERS
 TWO INTERMEDIATE RADIO FREQUENCY AMPLIFIERS - DETECTOR.

There are many people that claim the Super-Heterodyne is too complicated for an ordinary person and too difficult to tune. This is wrong and such a statement would never be made by one who has had experience with a properly designed Super-Heterodyne.

It is a fact that a Super-Heterodyne is easier to tune than a Regenerative receiver. Good advice in the Radio field is scarce, very scarce, and there is a good reason for it. Up to the time Broadcasting started three years ago there were about six good receiving engineers in this country. As it takes five to ten years to develop an expert receiving engineer, it is obvious that there are not many more than six receiving experts now. If one reviews the activities and many changes in design made to the various receivers offered by manufacturers during the past two years, this assertion is proven a fact. The writer is trying to emphasize the importance of being guided by a reliable firm and not by any of the "new experts" many of which rise and fall in about four months.

Since the first edition of this text, letters have been received from Mr. A. Ancieux advising that reception has easily been obtained on the Model C-J combination from E. Pittsburgh, Schenectady, Hastings, Oakland and other points, a distance of over 5,000 miles. Proof is shown further on.

During the operation of this type receiver many questions come up in regard to the various accessories required.

A good wavemeter is one of the most desirable accessories as it can be made extremely useful in many ways. Fig. 76 illustrates the General Radio Type 174 direct reading wavemeter which is an excellent instrument, covering a wavelength range of 160 to 3,000 meters. A Wavemeter is really a convertible instrument which can be used as a local transmitter to send out wavelengths of any predetermined wave, or a receiver to receive wavelengths of any unknown wave or known wave.

For example, suppose it is desired to receive the program from station WHB in Kansas City, operating on a wavelength of 546 meters. The wavemeter is set at 546 meters and the wavemeter buzzer started. This provides a weak local signal being broadcasted on 546 meters and the Super-Heterodyne is then adjusted until the wavemeter signal is heard with maximum intensity. When this condition is reached it indicates that the receiver is tuned to a wavelength of 546 meters, and after stopping the wavemeter the receiver is then ready to receive from Kansas City. It must be remembered that the transmitted wave-

length may have a slight correction. If these corrections are in opposite directions it means that the receiver will have to be readjusted slightly to bring in the station.

A more useful method of using the wavemeter is as follows: Suppose station WWJ in Detroit is carefully tuned in (wavelength 517 meters) and we then start the wavemeter buzzer and adjust the wavemeter dial until the wavemeter signal is heard with maximum intensity in the receiver. It is then obvious that the receiver is in resonance to both the WWJ wavelength and to the wavemeter wavelength. Now, by noting the wavelength to which the wavemeter is set we find the reading to be $517\frac{1}{2}$ meters, and make a record of that setting. On any future occasion that it is desired to receive WWJ, the wavemeter is set to $517\frac{1}{2}$ meters, the receiver tuned to the wavemeter signal, the wavemeter stopped and then WWJ will be there provided they are transmitting at that time. Complete operating instructions are supplied with these wavemeters.

It is obvious that unless the wavemeter is accurate it will be of little use other than for comparative readings.

For broadcast entertainment reproduction the selection of a good loud speaker is of great importance. Fig. 77 illustrates the Western Electric Type 10-D Loud Speaker which is recommended without any hesitation. This instrument gives faithful reproduction and good volume.

In cases where still greater volume is required the Western Electric type 10-A Loud Speaker and Power Amplifier is suggested (Fig. 78). The power amplifier in this combination consists of two stages of low ratio distortionless audio frequency amplification, the last stage arranged for the push-pull system. The telephone and horn portion is the same mechanical dimensions as the 10-D, but the electrical values are totally different than the 10-D and this type 10-A telephone and horn should never be used without the power amplifier. Full instructions for connecting the Power Amplifier are supplied with each instrument. When using the 10-A with the Model C Super-Heterodyne, it is important that the Loud Speaking equipment be placed to the right of the Super-Heterodyne equipment. Separate B batteries should be used for the Model C and 10-A equipments. 120 volts are required for the power amplifier. A common 6-volt storage battery can be used for both the Model C and 10-A equipments.

In practice usually two stages of audio frequency amplification are all that is necessary for ordinary purposes. Accordingly, when using

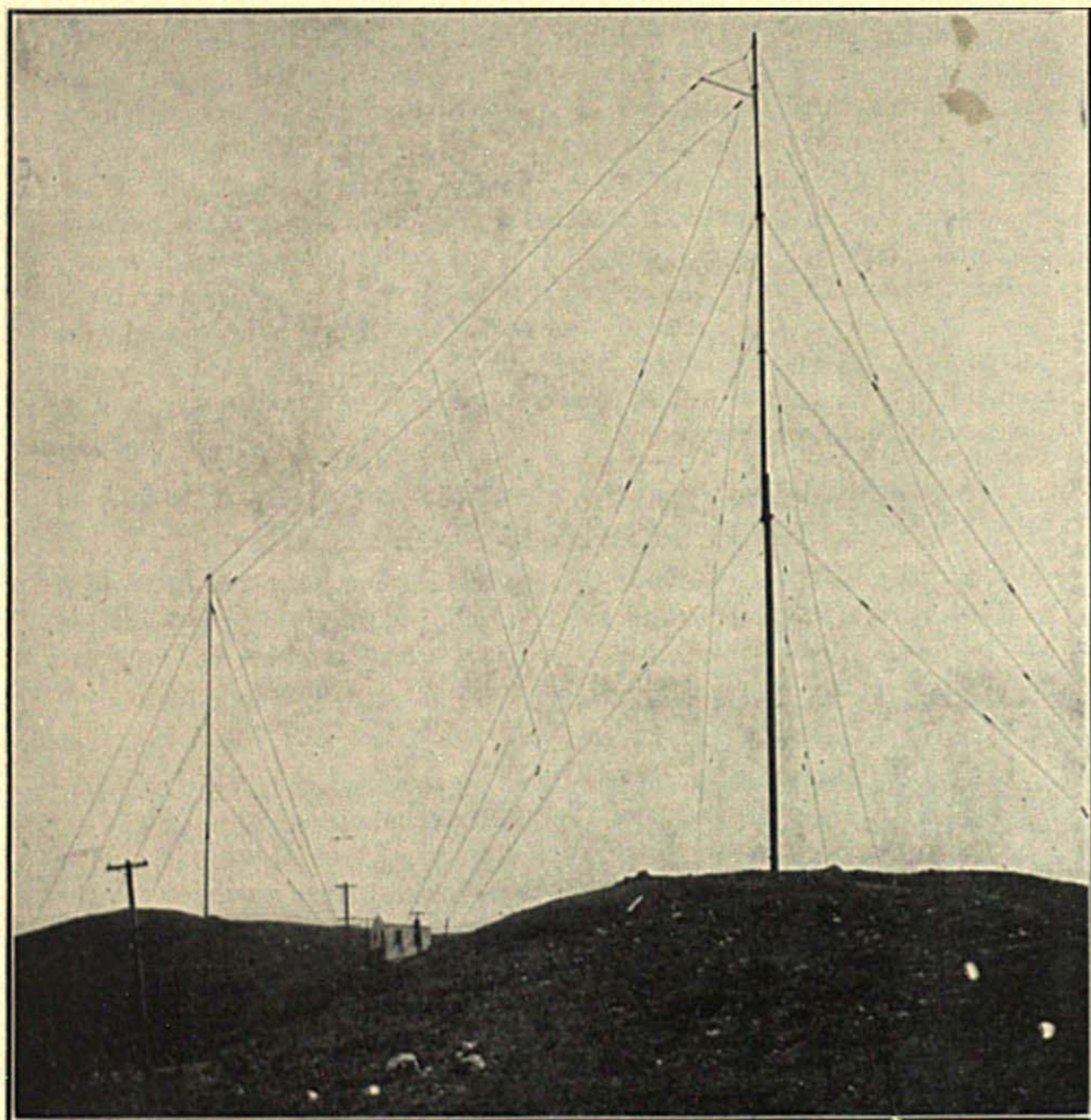

Fig. 95

Aerial System of an Experimental Transmitting and Receiving Station.

the 10-A equipment with a Model C Super-Hetrodyne, the input of the amplifier should be plugged into the Detector Jack on the Model C. For still greater amplification the input can be plugged in the 1st Audio Jack giving a total of three audio stages. It is possible to plug the input into the 2nd audio jack giving a total of four audio stages, provided the wiring is all carefully distributed and the negative filament lead ground. When using three and four stages of audio amplification the static disturbances are usually very loud and objectionable.

The Western Electric Co. also produces an attachment operating from ordinary A/C light lines, which provides the necessary filament and plate current for the 10-A Power Amplifier, without requiring any batteries. While such an attachment can be used successfully for an amplifier, it is not possible to apply this same unit to supply a complete receiver.

For storage battery charging, when the supply line is alternating current, the General Electric "Tungar" charger is suggested. To operate one of these chargers it is simply necessary to connect two clips to the storage battery (red to positive) and insert the Plug in the electric light socket. The Tungar is illustrated in Fig. 79. This charger is made in two sizes, $2\frac{1}{2}$ amperes and 5 amperes. The larger size charges the battery twice as fast as the smaller unit. When the receiver voltmeter reads below 5.8 volts, the battery should be recharged again. Full directions for using the Tungar accompany the instruments. Directions for the proper care of a storage battery also accompany each battery.

The proper selection of good B batteries is important. Eveready and Burgess types are undoubtedly the most reliable, and cheaper types should never be used. Two No. 767 batteries which have a total of 90 volts and taps at 45 and 22 for detector, are excellent batteries for the C or L model Super-Heterodyne.

Storage B batteries are now being recognized as satisfactory and there are several reliable makes on the market. Two Willard 48-volt 5-ampere hour batteries in series will make a good "B" supply. These batteries can be charged from 110 volt A. C. house mains through the use of a small chemical rectifier also marketed by the Willard firm. From direct current lines the B batteries can be charged by connecting to the line in series with a 50-watt lamp, making sure that the positive side of the line goes to the positive side of the B battery.

When inexperienced persons use a radio receiver they sometimes refer to "frying" noises, "cracklings," etc., and attribute these

to defects in the receiver. Usually the disturbances mentioned are static, and to date a satisfactory static eliminator has not been invented.

A test to determine if the noises encountered are static consists of removing the antenna and ground leads from the receiver. If the noises continue with the same intensity it is an indication that the disturbance is due to a loose connection or a defective tube or battery, or probably, if the disturbance stops, it is an indication that it is coming from the antenna.

A copy of E. H. Armstrong's Patent on the Super-Heterodyne can be obtained from the Patent Office, Washington, D. C., by remitting ten cents and asking for Patent No. 1,342,885.

The following abstracts from the original patent specifications confirm the claims of superiority, for example "Another result achieved by the use of this invention is that because of its selectivity the interference caused by undesirable signals, strays and atmospherics is greatly reduced." "The present invention may also be used to a great advantage on wavelengths from 300 to 1,000 meters with a considerable gain in selectivity and sensitiveness, as compared to any of the known methods." "It should be particularly noted that the reception of spark signals and telephonic speech is accomplished without the hissing or distorted tone which invariably results when the ordinary form of beat or heterodyne reception is employed."

The patent paper also points out the possibility of carrying out the Super-Heterodyne action twice, for example the incoming signal of 300 meters is changed to 3,000 meters at which point it is amplified and then changed again to a still lower frequency of say 10,000 meters and amplified a second time. This feature could be carried out several times. The advantage is due to the fact that the two or more amplifiers work at different frequencies and therefore the input and output sides of the amplifier are further isolated and the interaction eliminated. In working out a multiple system of this type for phone reception the frequencies of the two oscillators must be selected with a view to prevent audible beats from harmonics or from the incoming carrier waves which in actual practice is a difficult proposition, still it is practical.

This book does not go into detail as to why a vacuum tube rectifies, oscillates or amplifies or does it cover the various theoretical reasons for the different radio frequency actions. To cover this phase would only duplicate the work of early writers.

A good antenna for use with a Super-Heterodyne consists of a single wire about 150 feet long measured from the far end to the

receiver. This wire should preferably be in one piece. The higher the better, for example, a wire 50 feet long 100 feet high with 100 foot lead in would be preferable to a 100 foot wire 50 feet high with a 50 foot lead in. However, due to the question of support, most installations must be only 30 to 50 feet high. It is suggested that the far end of the wire be pointed in the general direction of the most broadcasters. The wire may be No. 14 or No. 12 B. & S. copper wire, bare or rubber insulated weatherproof, preferably the latter. Insulate the wire at both ends with porcelain ball or rod insulators and also insulate the wire with a porcelain tube where it runs through the wall of the house. A good receiving ground usually consists of a clean connection to water pipes.

MODEL C-10 RECEIVER

A new receiver has recently been designed by the writer known as the Model C-10. (Figs. 95A, 95B, 95C and 95D). This set has 10 tubes all contained in a single 40-inch cabinet. The tube arrangement consists of three stages of tuned radio frequency amplification, highly selective and fully neutralized Regenerative Detector. The tuning for these first three amplifier tubes and detector being accomplished with a single dial. There is provision to make a separate antenna circuit adjustment independent of the amplifier tuning. The remaining tubes consist of two intermediate radio frequency amplifiers, 2nd detector and two stages of audio frequency amplification. This unit is practically a C-7 Model with three stages of tuned radio frequency in front of it, all contained in the same cabinet. A separate unit having two or three stages of tuned radio frequency amplification such as a Model J could be placed in front of a Model C-7 to obtain the same results, but with more dials. This new model has the dials graduated to station call letters. The graduations are on German Silver Dials. Pencil calibrations can be made on the lower half of the dial and erased as desired.

All the transformers are shielded from each other by brass barriers. In addition the low wave and different sets of transformers can readily be inserted for short wavelength reception from England, which is not a difficult feat at the low wavelength employed.

When the final design is worked out undoubtedly Blue Print designs will be available.

Radio Frequency and Audio Frequency Transformers are shielded in iron cases. The variable condensers are entirely shielded and the

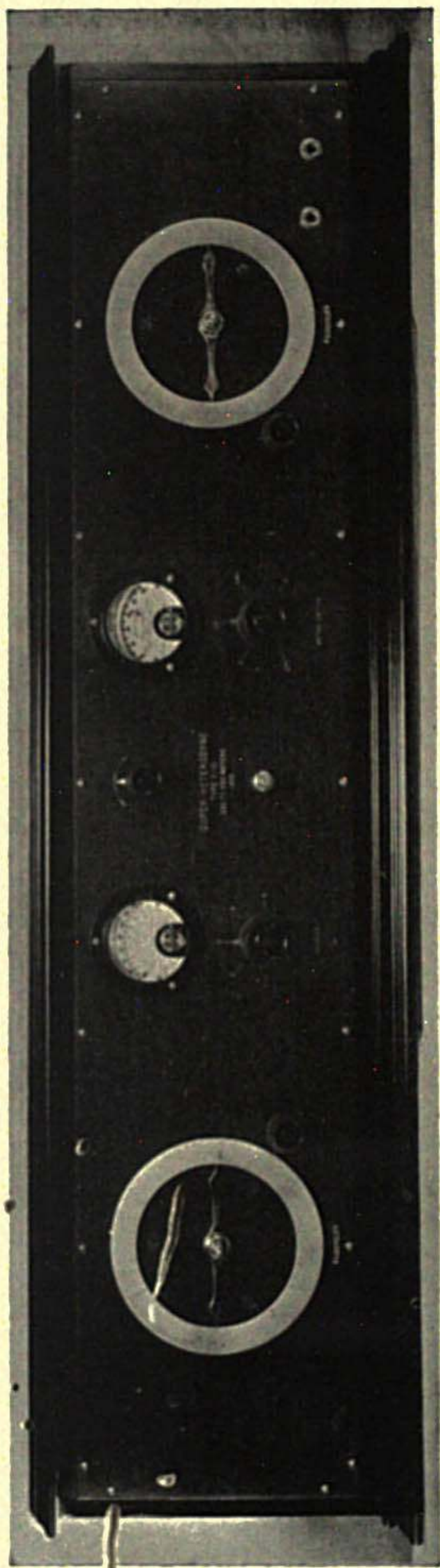

Fig. 95B
Model C-10, Front View.

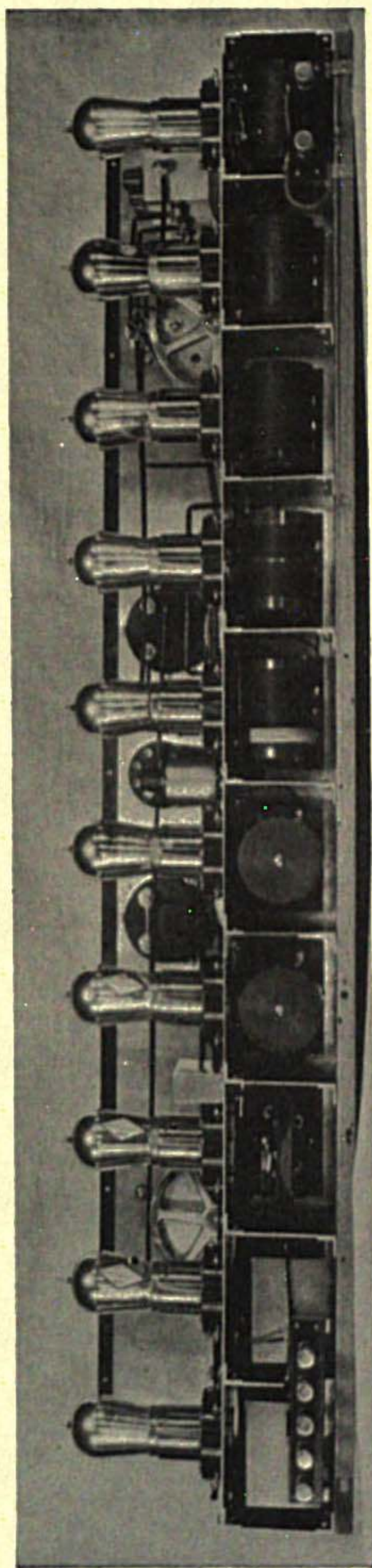

Fig. 95C
Model C-10, Rear View.

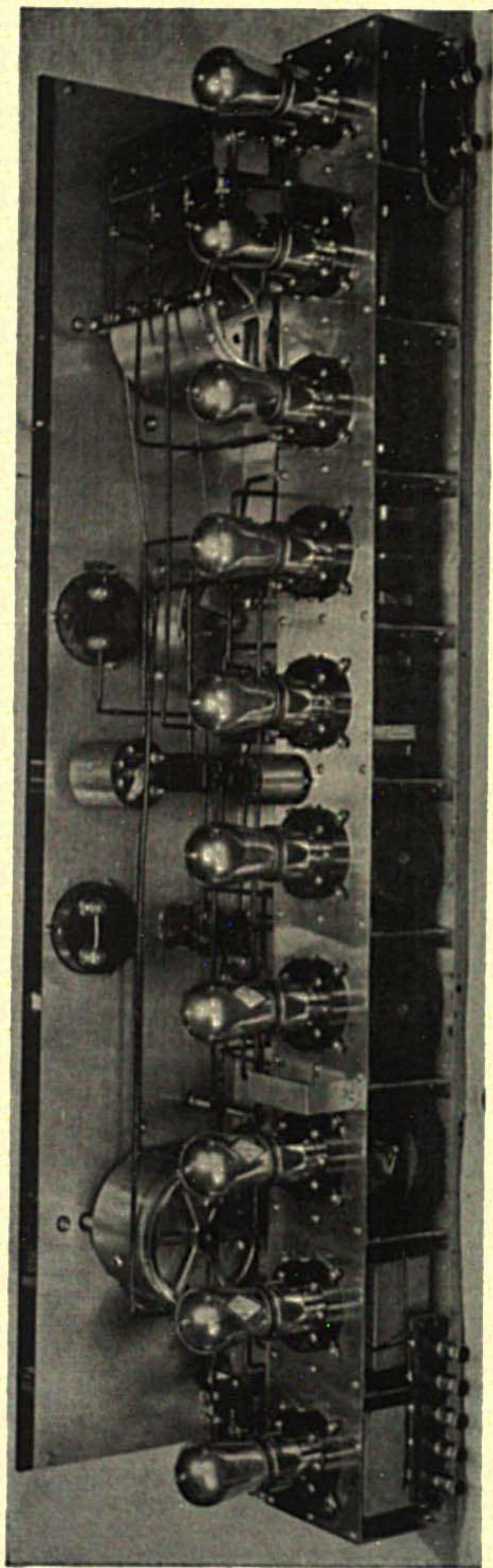

Fig. 95D
Model C-10, Rear Angle View.

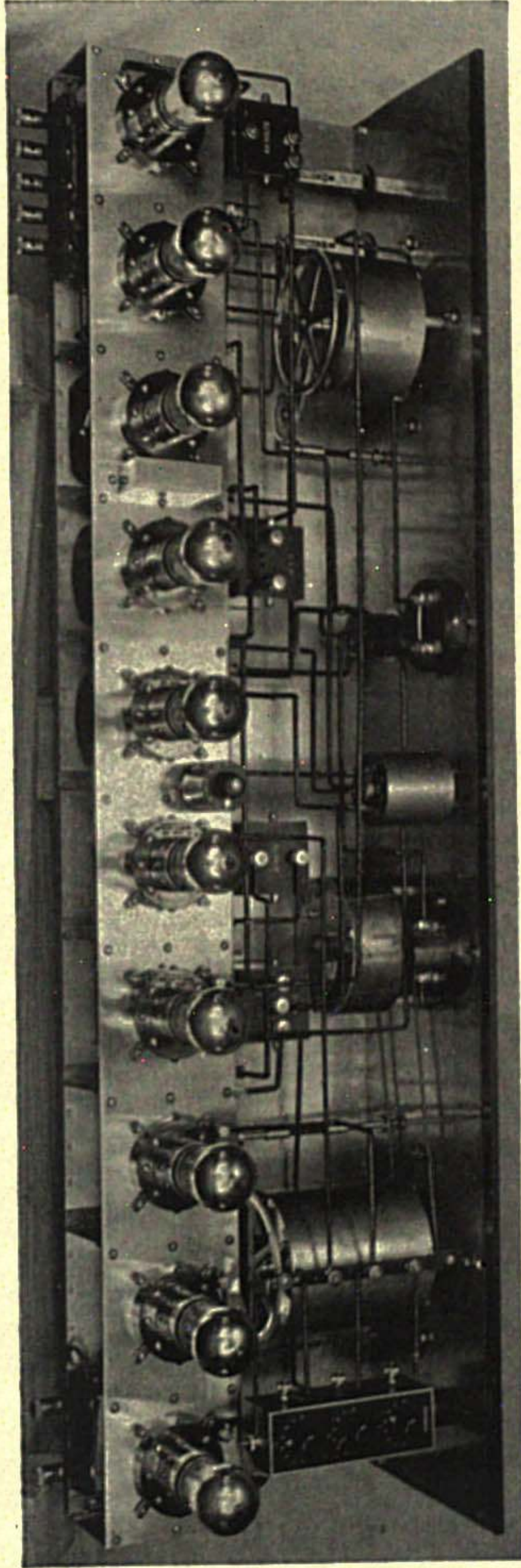

Fig. 95E.
Model C-10, Top View.

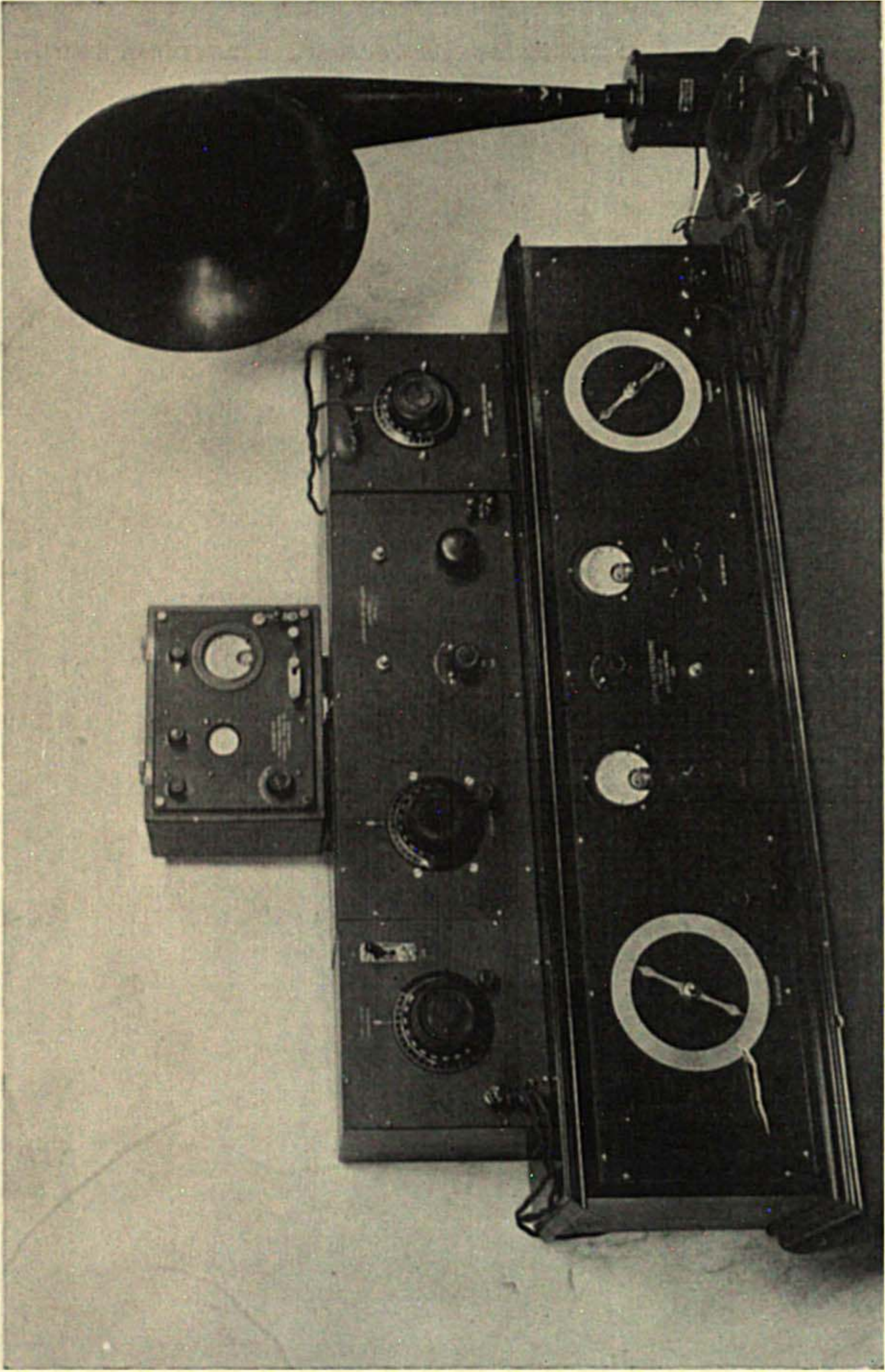

Fig. 95F.
Montauk Point Installation.

multiple condenser having three separate condensers has each condenser shielded from the other. The entire case is shielded.

The filament temperature is regulated by fixed resistors previously selected as to the proper value.

Inasmuch as the entire case is shielded and there are muffling stages ahead of the oscillator this set will give a minimum of radiation. By shielding the A battery leads and A battery there would be practically no radiation. The B battery is contained within the shielded cabinet.

Insulating mechanical verniers are provided to eliminate the slightest body capacity effect.

The total amplification is greater than can be used during ordinary weather conditions and a Volume Switch is used to regulate the intensity of total amplification. All transformers are interchangeable on plugs. During the coming winter season it is expected that this set will break all records.

MONTAUK POINT INSTALLATION FOR RECEPTION FROM ENGLAND

Main C-10 Super-Heterodyne in lower center. (Fig. 95F). Laboratory Oscillator directly above C-10 unit, this oscillator is set to wavelength of station desired and used as an artificial signal to make preliminary tuning adjustments. Wavemeter used by reaction method on oscillator to check wavelength setting of the Super-Heterodyne and Oscillator.

Units on left and right of Oscillator are special Filters to eliminate any interfering signals on wavelengths close to the desired wavelength.

Antenna consists of a single wire terminating west and pointing directly to England along the beach at Montauk, Long Island. Length of Antenna is adjustable. Height of Antenna only 12 feet.

Preliminary test made during last week in October gave strong signals from practically every important station in the United States and Canada.

Havana and Tuincucu are particularly strong. 600-meter ship stations just outside of Southampton, England, were very strong. All indications point to successful reception from England while they broadcast during the favorable time period of 10:00 to 11:00 P. M. E. S. T.

THE DEVELOPMENT OF CUNNINGHAM RADIO TUBES AND THEIR APPLICATION TO THE BROADCAST RECEIVER

The invention of the three element vacuum tube and the tremendous improvement through constant research and development has made possible the highly efficient systems of broadcast transmission and reception in use today.

The radio tube functions primarily from the ability of certain materials, when heated, to emit electrons and thereby produce electrical conduction across the inter-electrode space. This electron stream is generally referred to as the plate current and is varied by the input voltages applied to the grid. The mechanical design and spacing of the electrodes determines only the operating characteristics of the radio tube, the operating efficiency depending entirely on the ability of the filament material or cathode when heated to emit electrons. The ratio between plate current or emission and required filament energy is the measure of relative efficiency.

The development in Cunningham Radio Tubes has therefore been along the lines of maximum amplification with a minimum of supplied filament energy.

The first Cunningham Radio Tubes announced in 1920 were types C-300 and C-301, both of which used a pure tungsten filament as the source of electrons and these tubes required 5 watts (1 Amp. at 5 volt) to heat the filament sufficiently to produce the necessary emission or plate current. A three-tube set using these tubes required storage battery operation with frequent recharging.

Further development to reduce filament energy without loss of amplification resulted in Types C-11 and C-12. These tubes use an oxide coated platinum filament as the source of electrons and have a plate current approximately that of the C-301 with filament energy only .27 watt (.25 Amp. at 1.1 volt). This was a decided advance in electron emitting efficiency over pure tungsten.

More recent development has resulted in the discovery by the Research Engineers of the General Electric Company of a new filament or cathode material of extremely wonderful electron emitting properties. This is the material used in the filament of the C-301-A and C-299. Upon the announcement of C-301-A on March 1, 1923, C-301 was withdrawn from sale.

Radio tubes perform two distinct functions in the broadcast receiver—detection and amplification. The present Cunningham Radio Tube

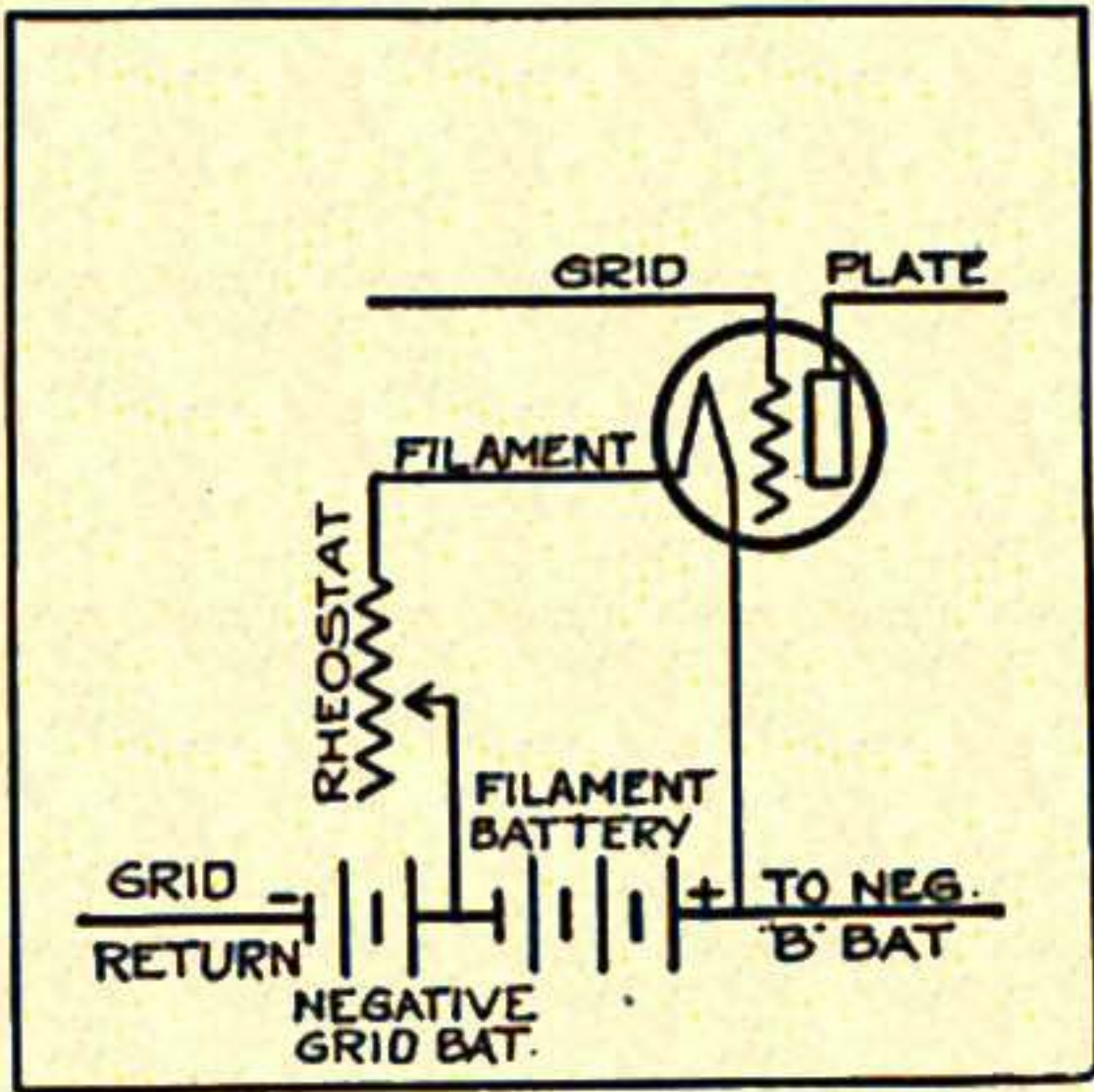

Fig. 96

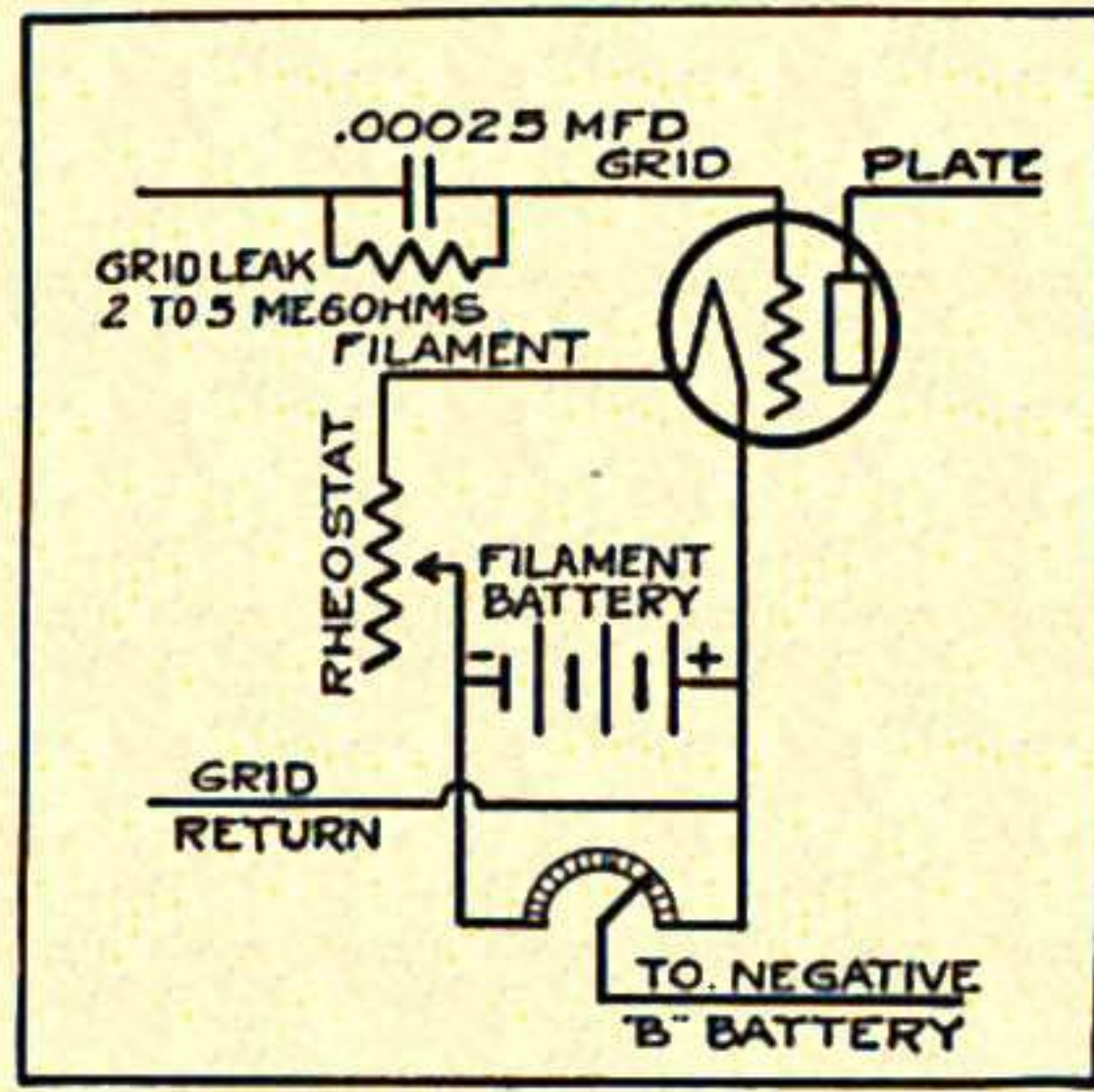

Fig. 97

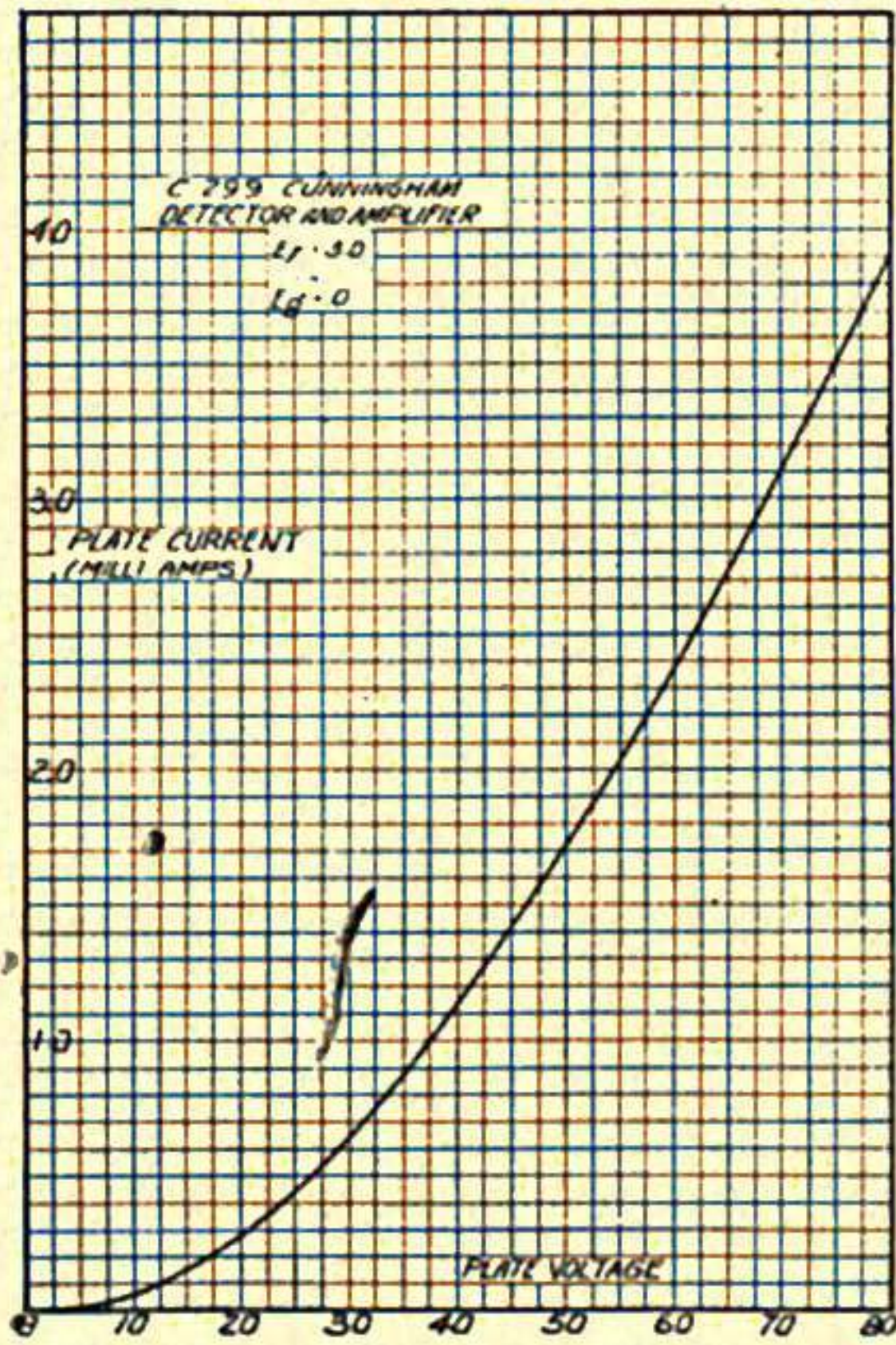

Fig. 98

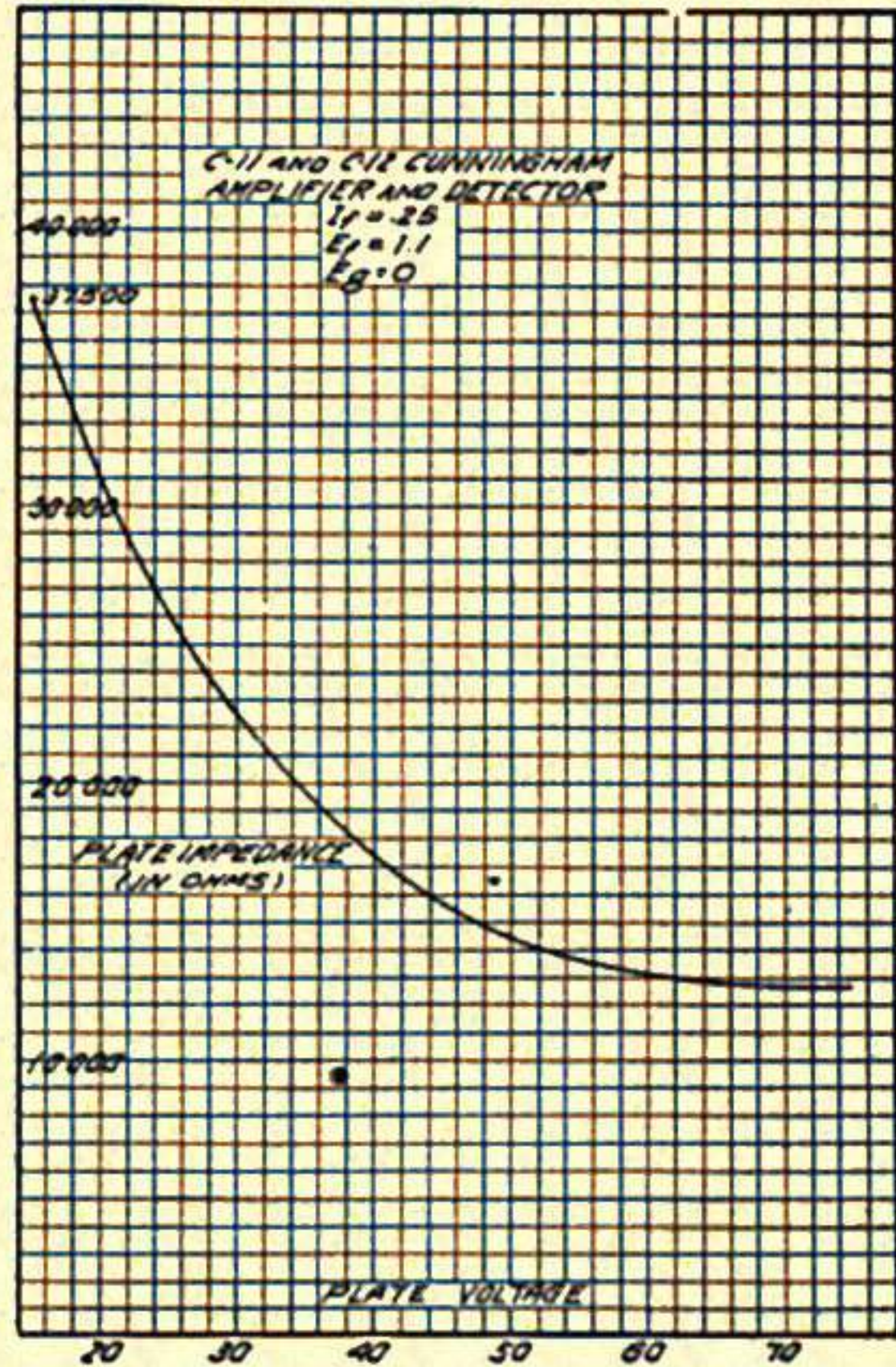

Fig. 99

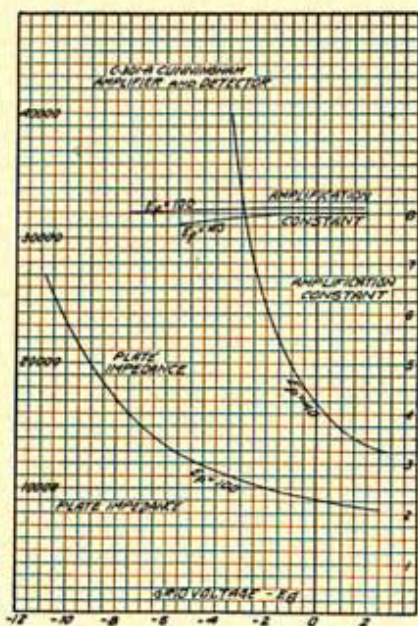

Fig. 100

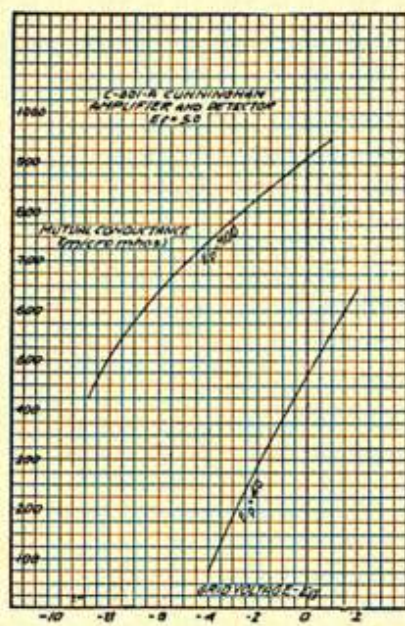

Fig. 101

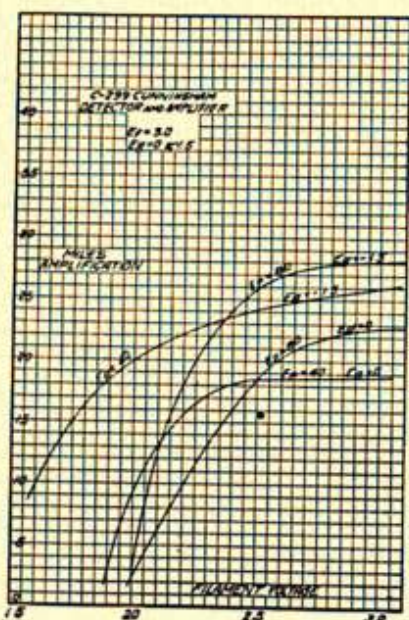

Fig. 102

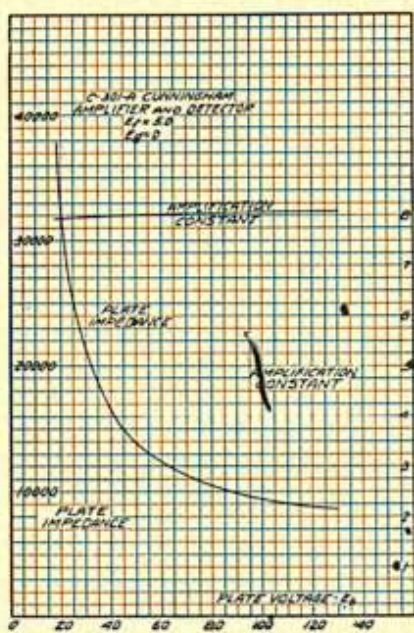

Fig. 103

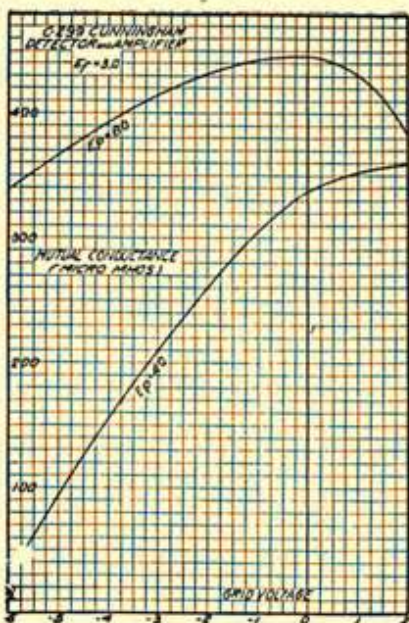

Fig. 104

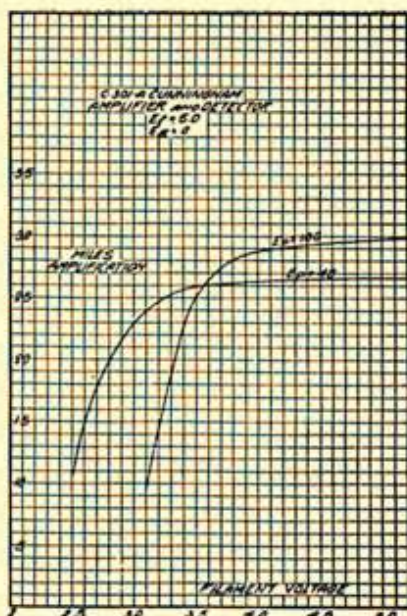

Fig. 105

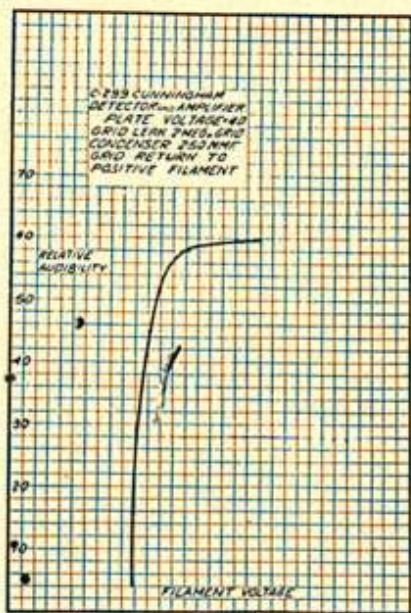

Fig. 106

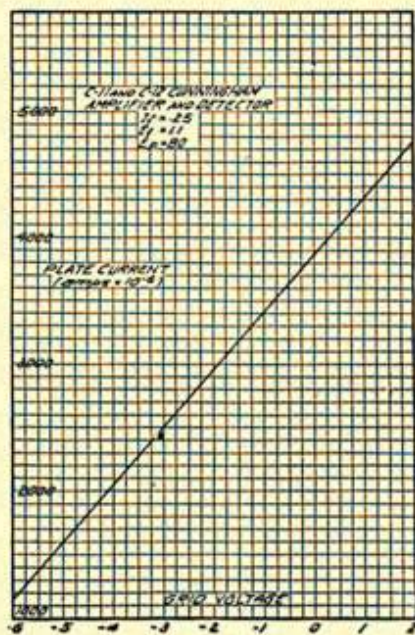

Fig. 107

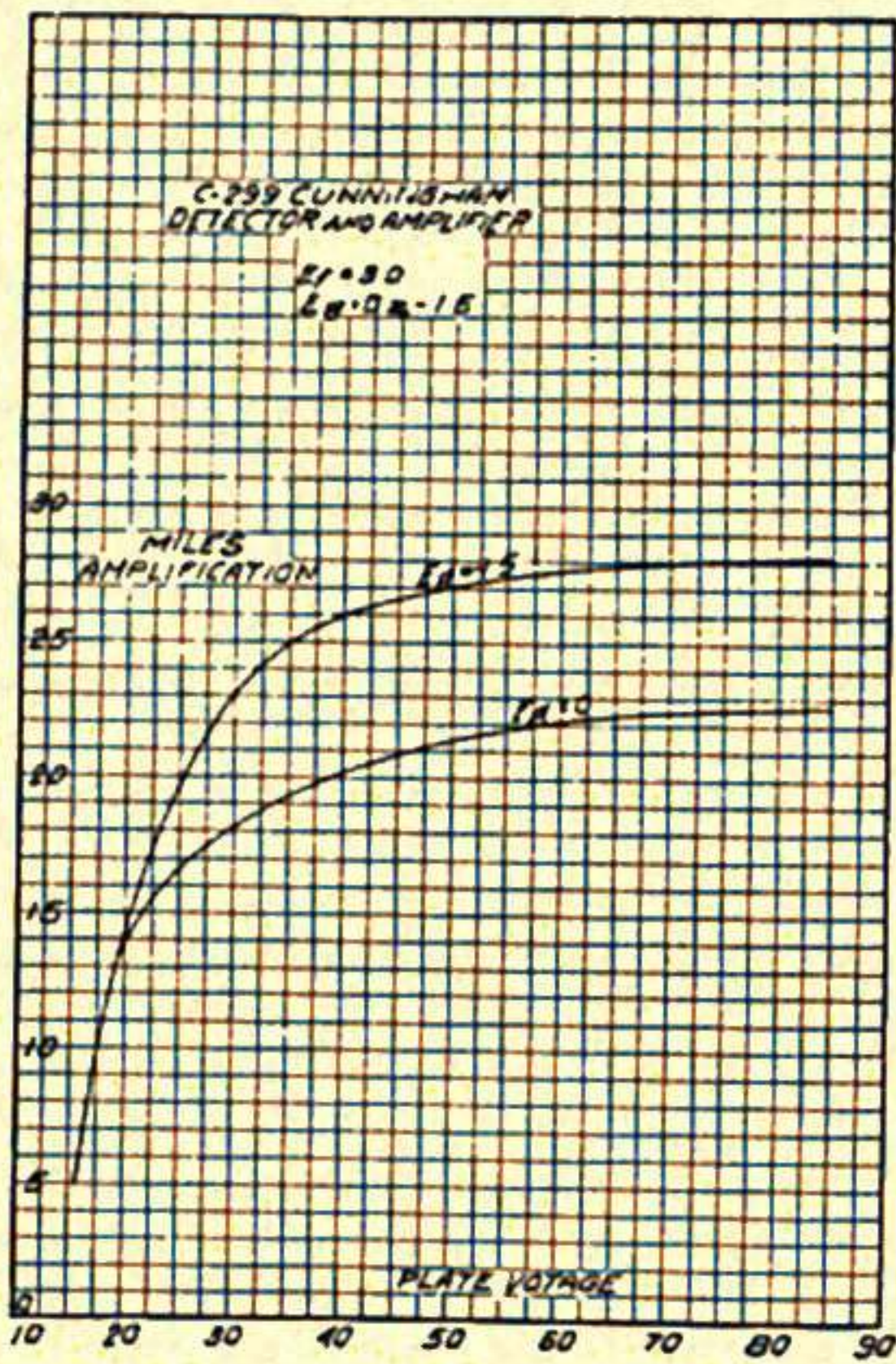

Fig. 108

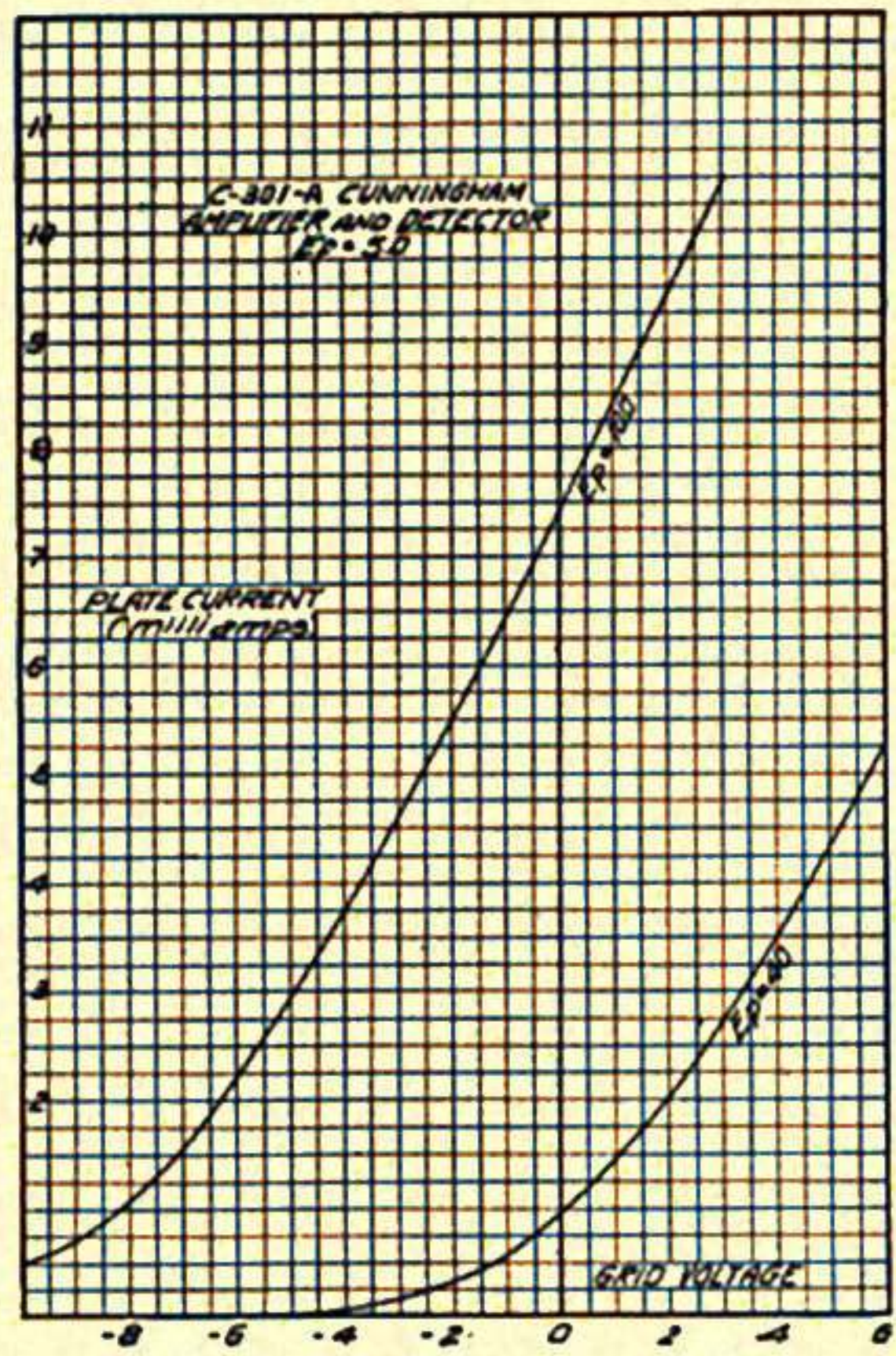

Fig. 109

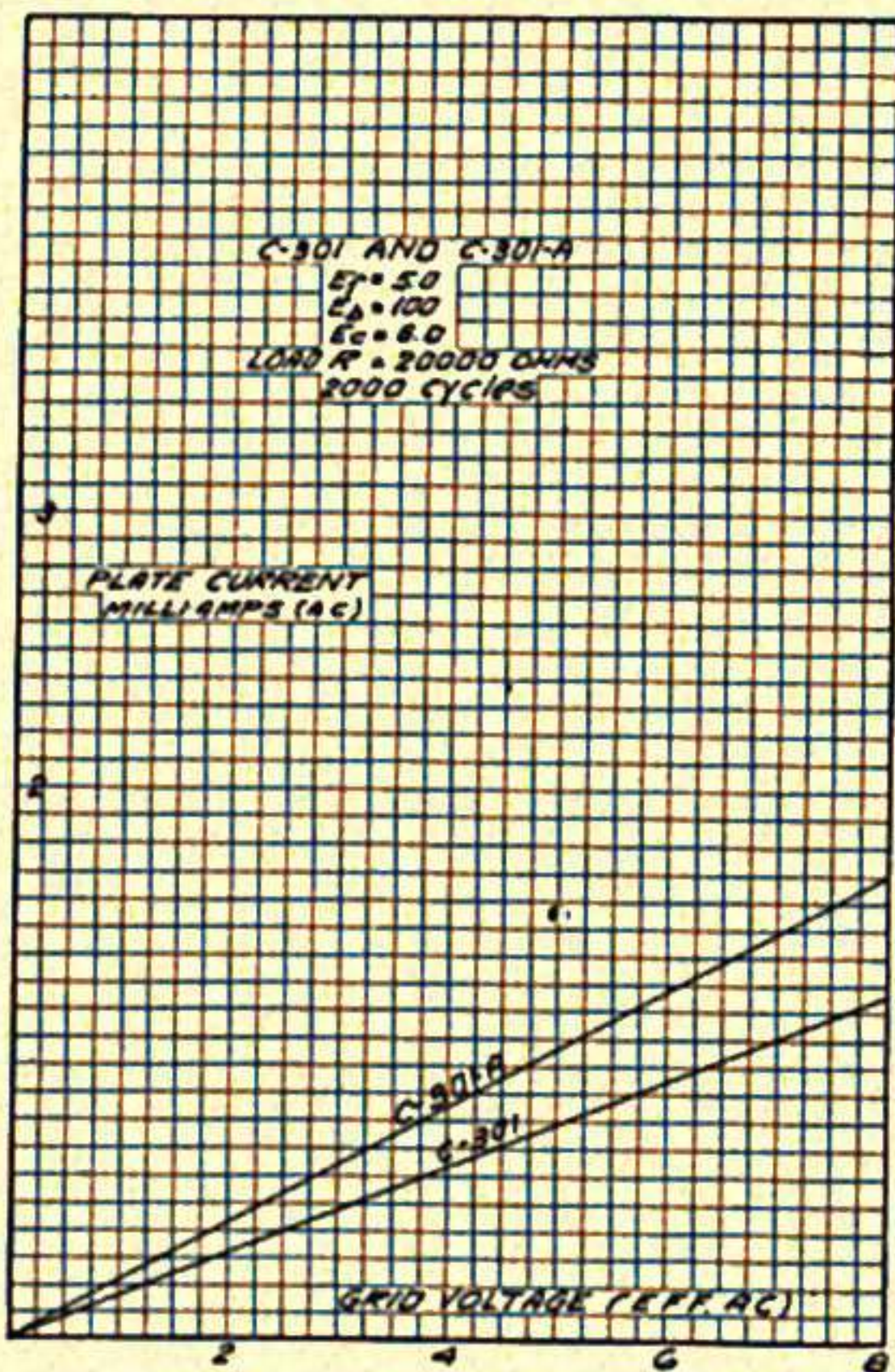

Fig. 110

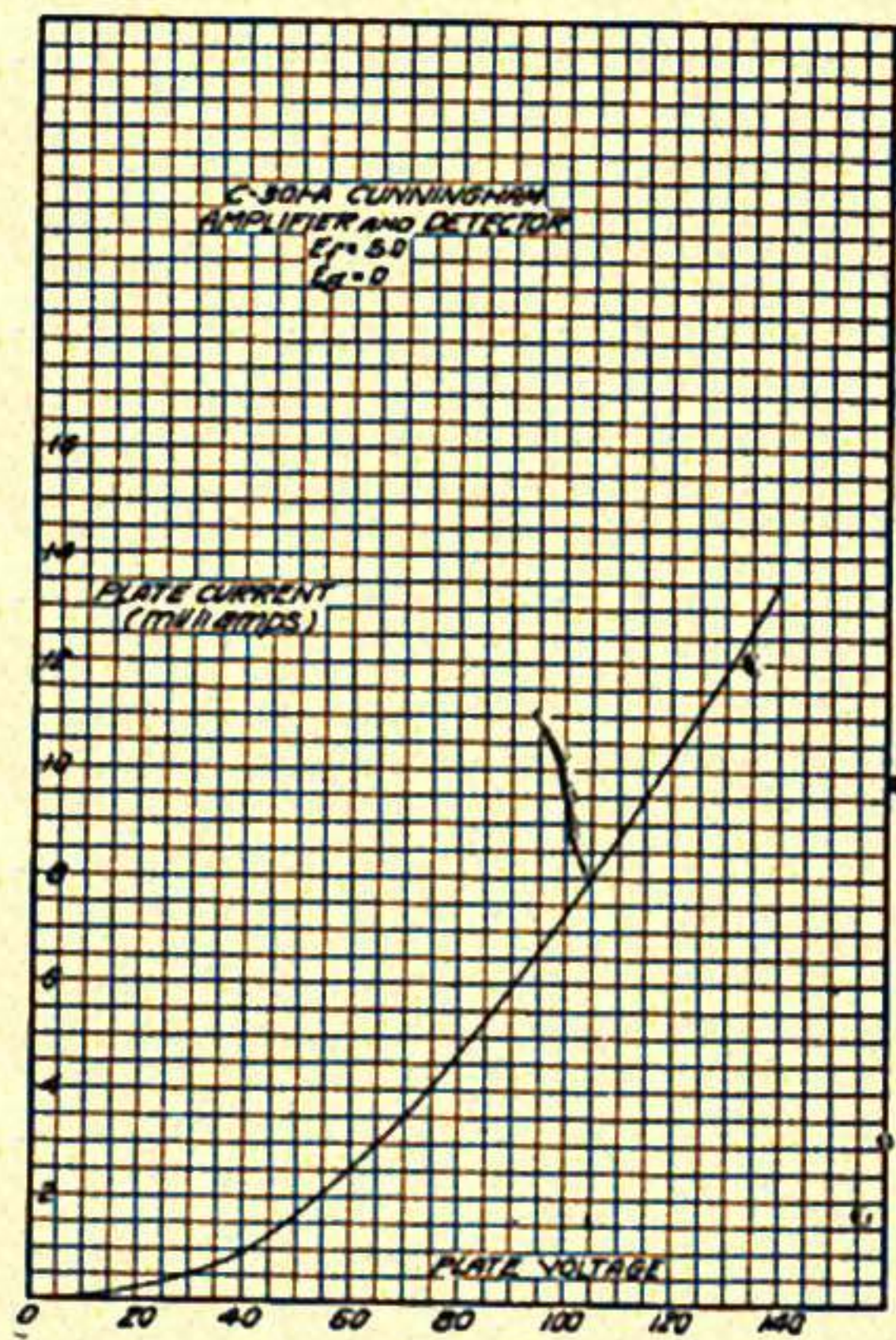

Fig. 111

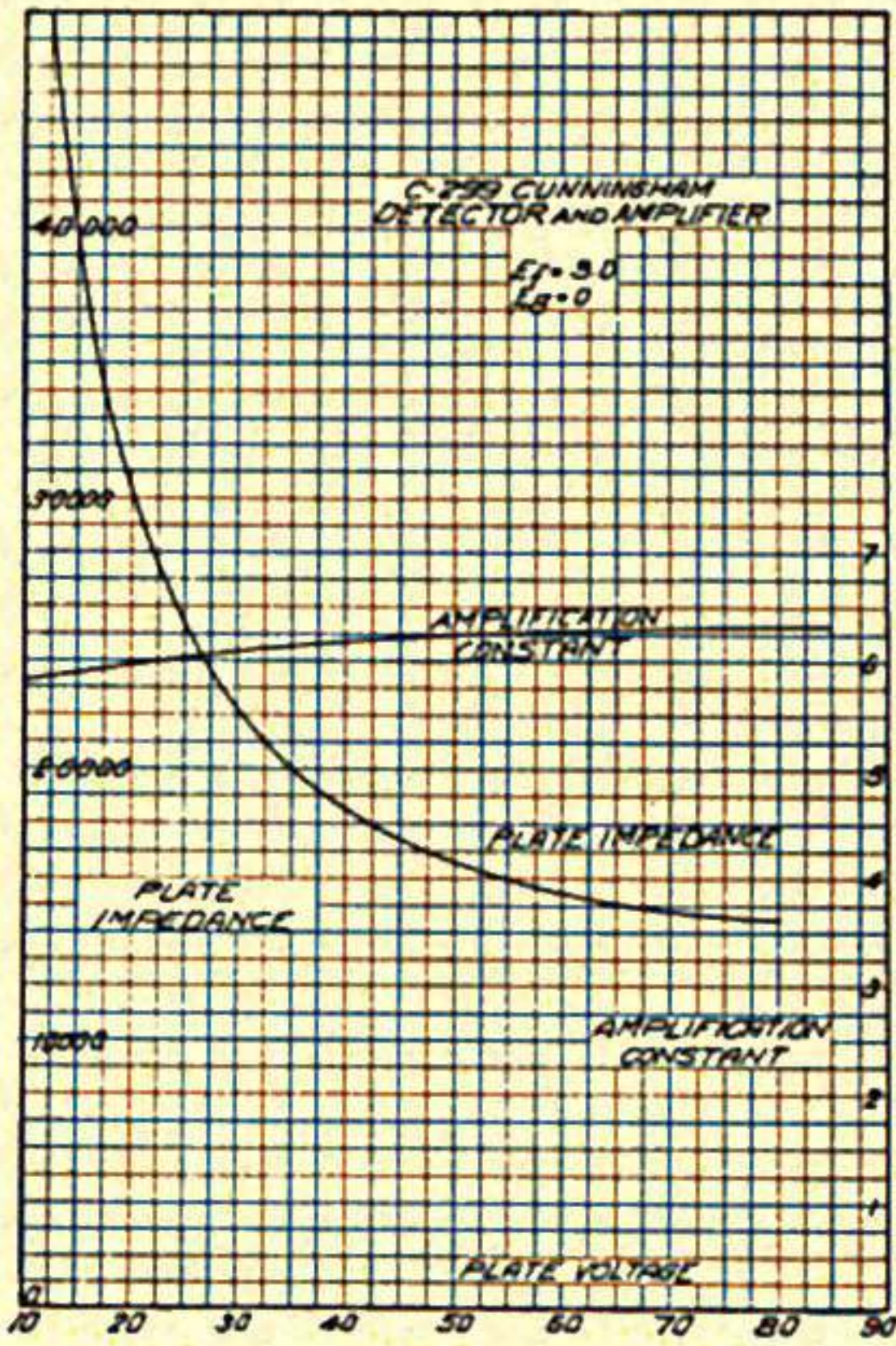

Fig. 112

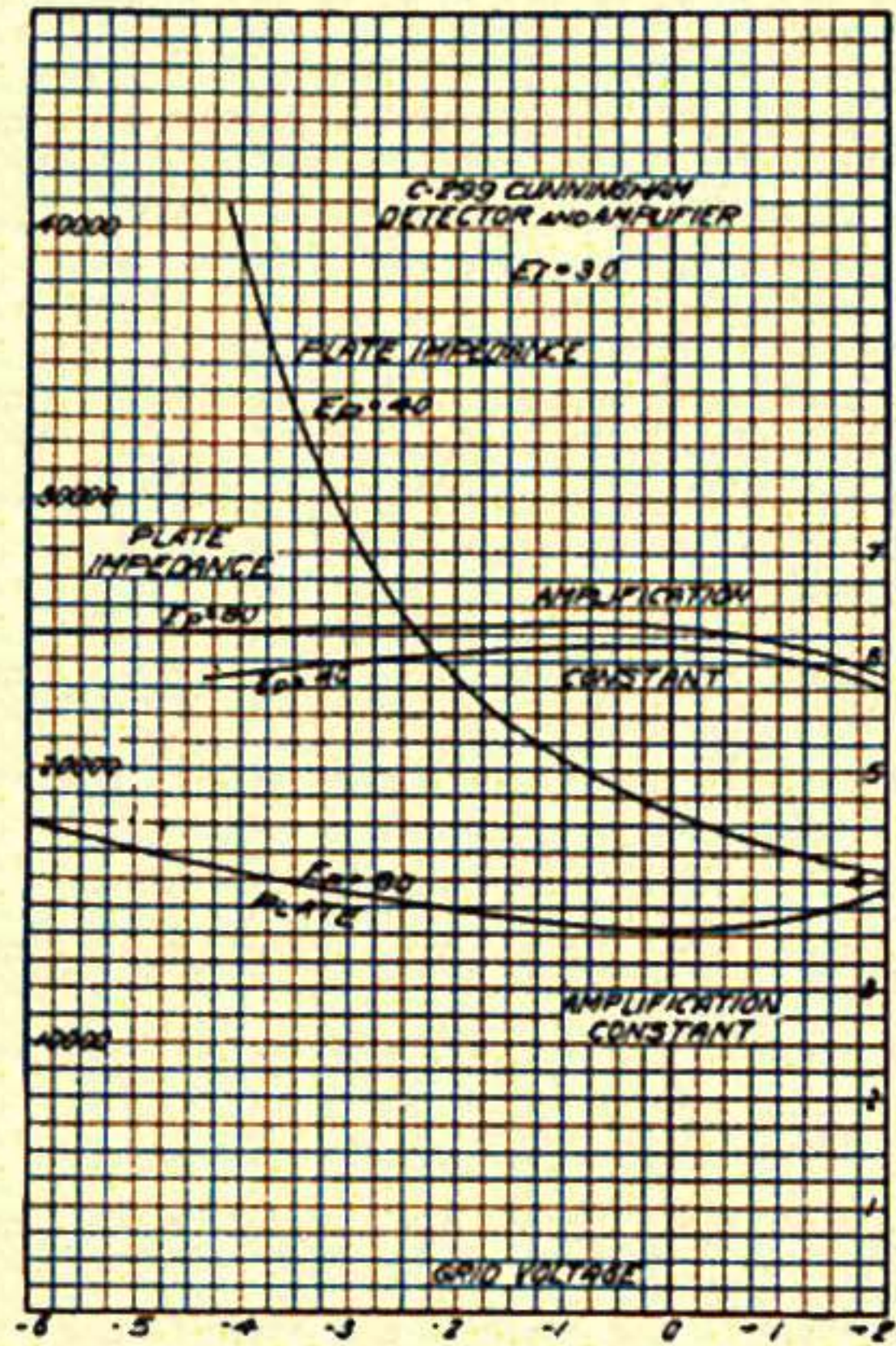

Fig. 113

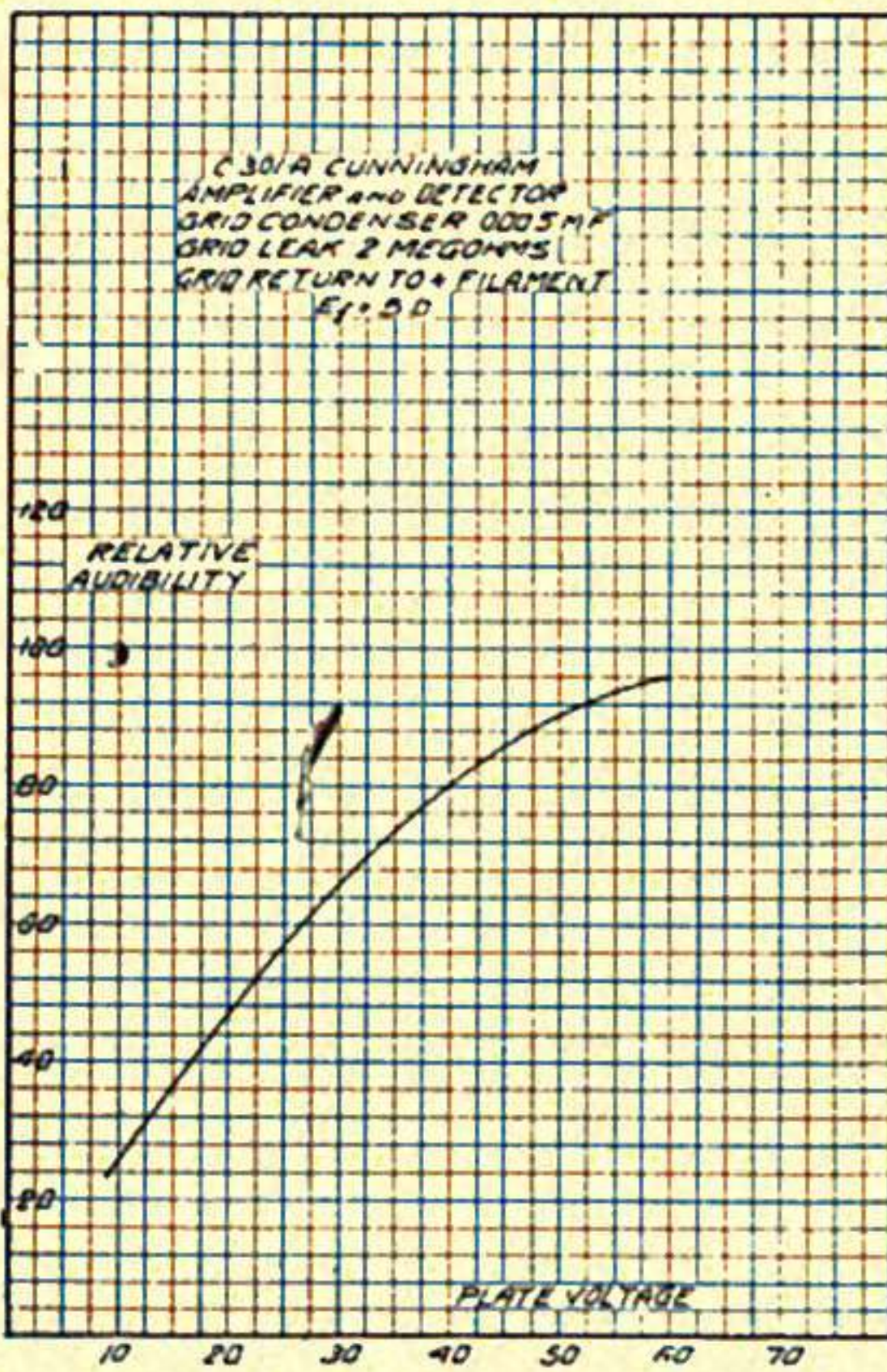

Fig. 114

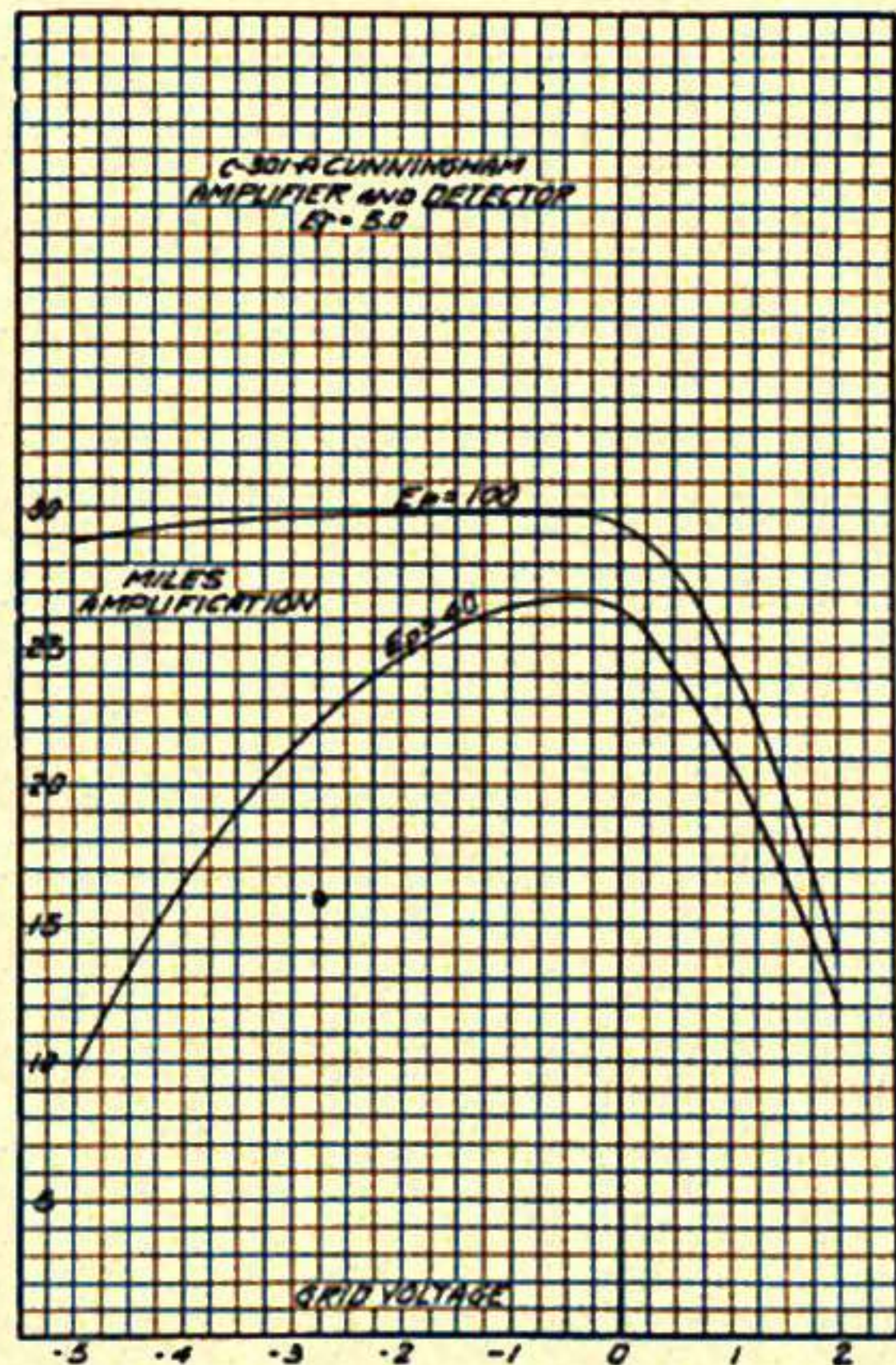

Fig. 115

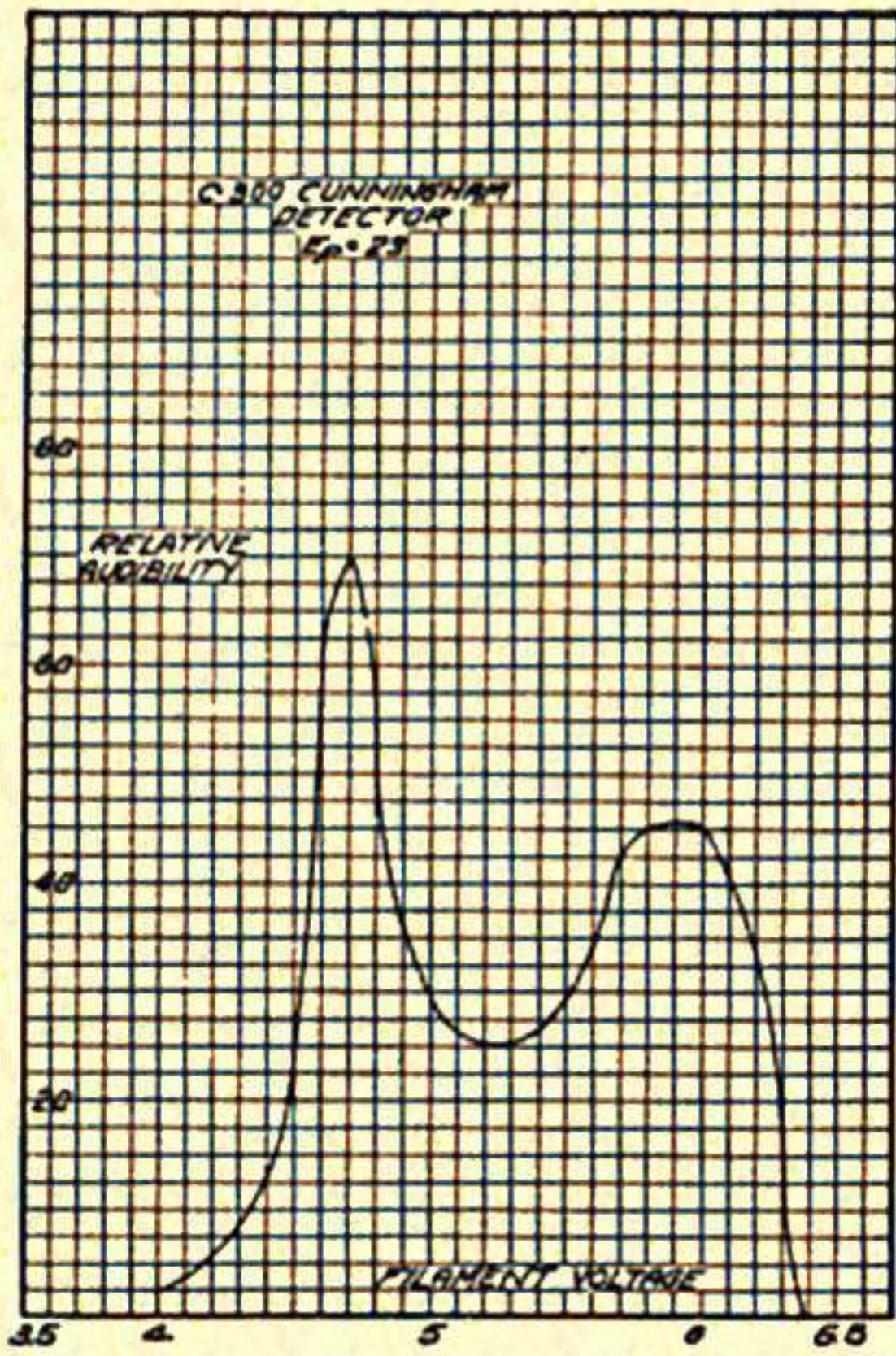

Fig. 116

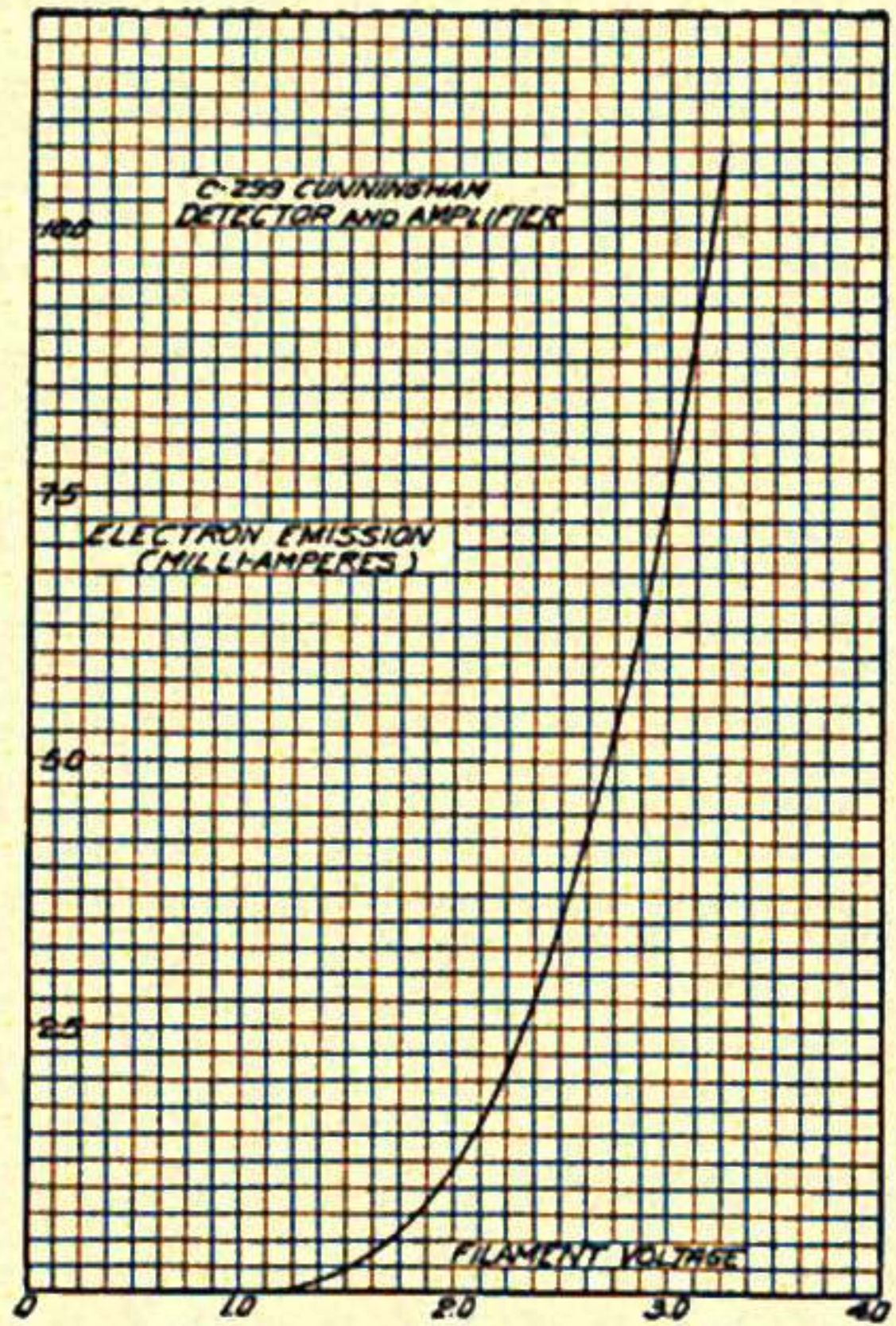

Fig. 117

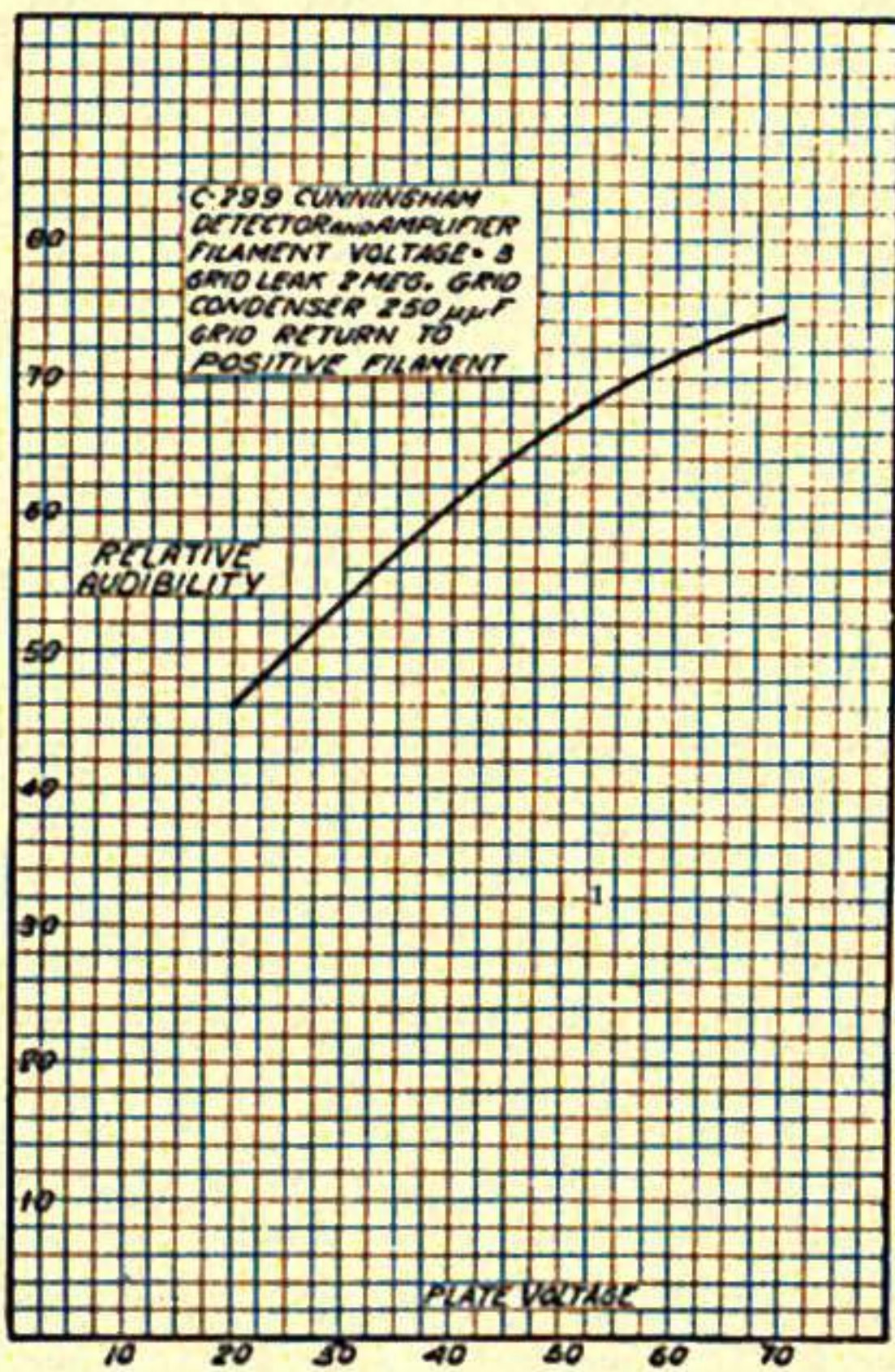

Fig. 118

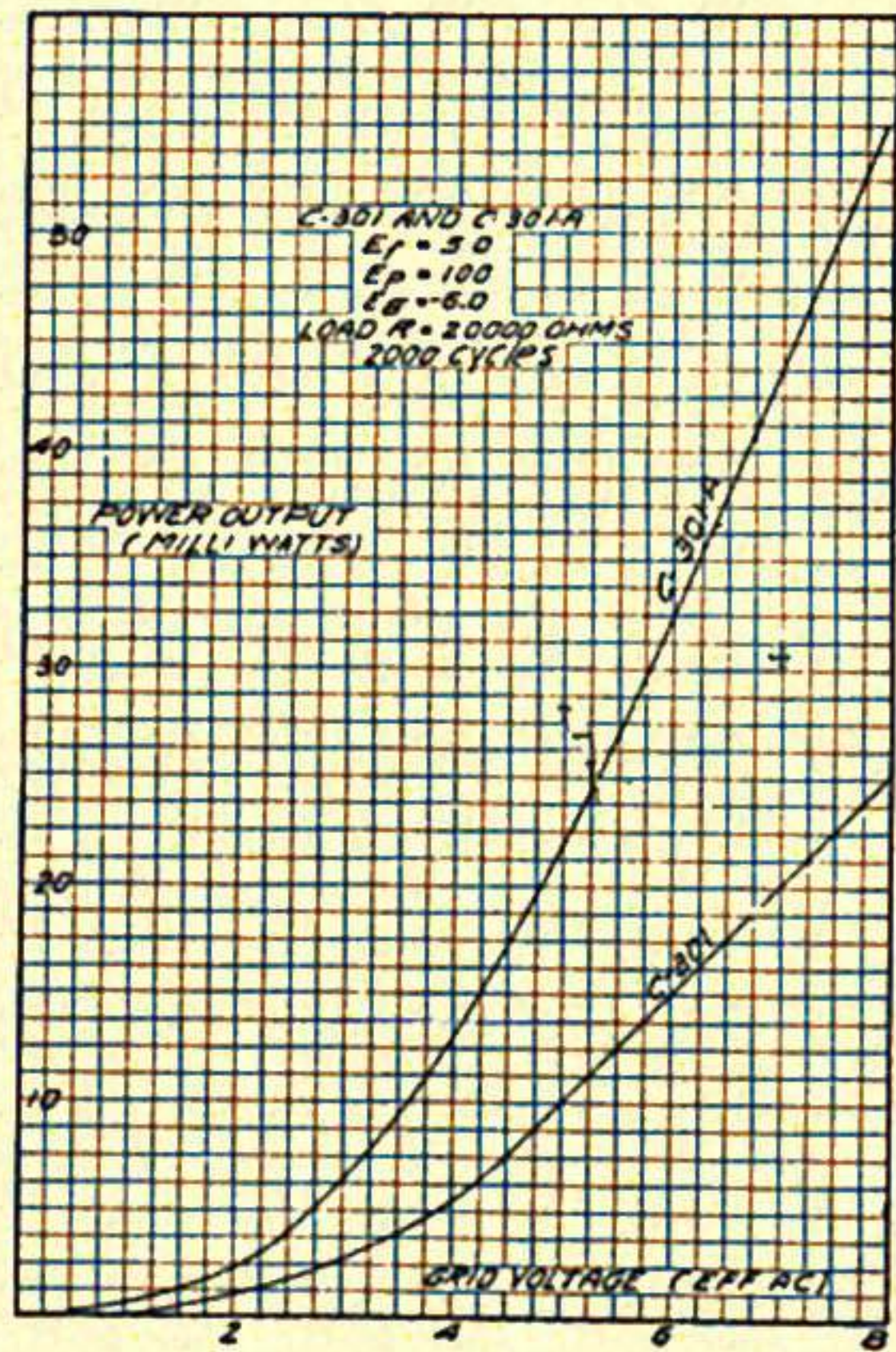

Fig. 119

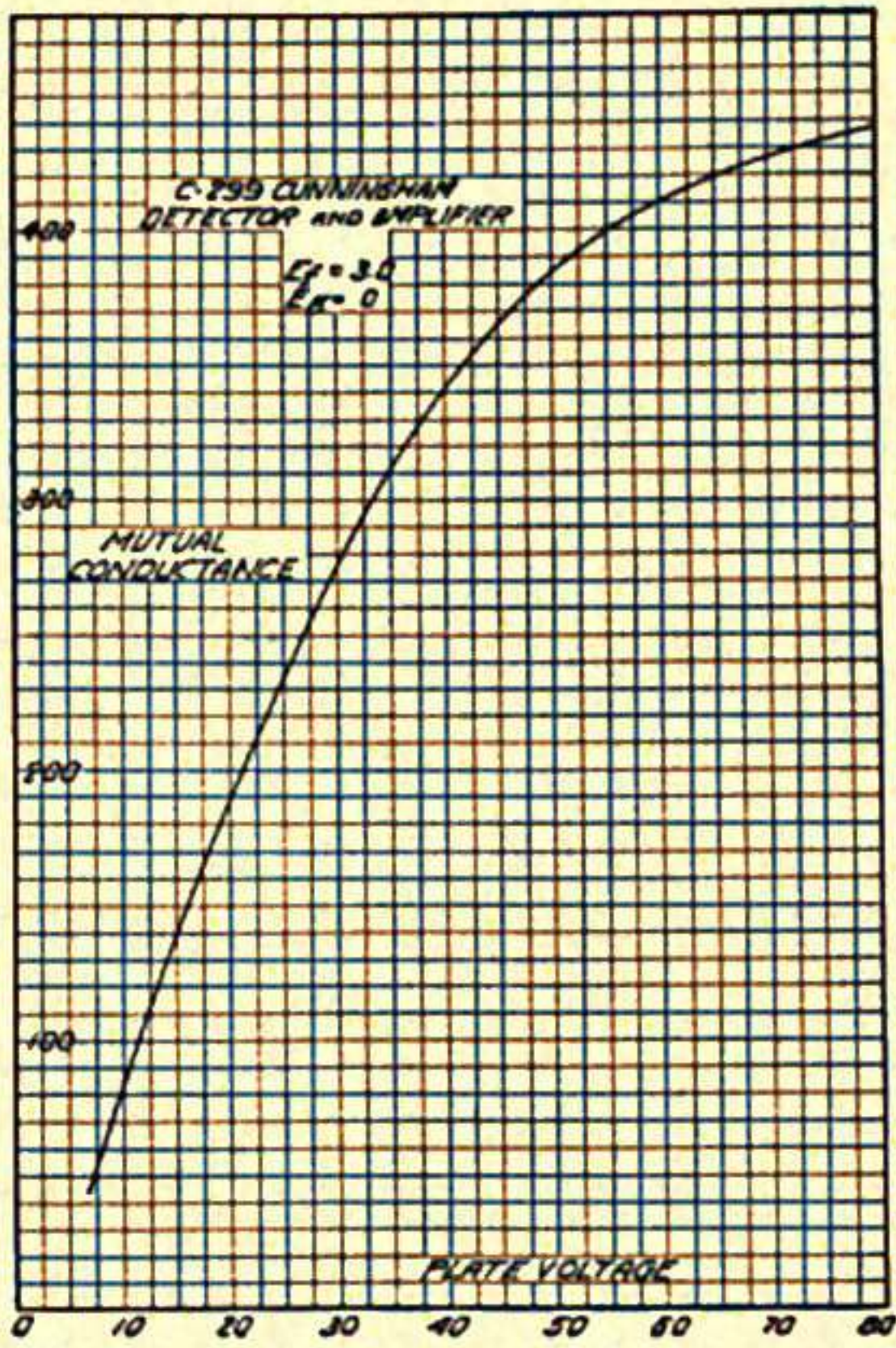

Fig. 120

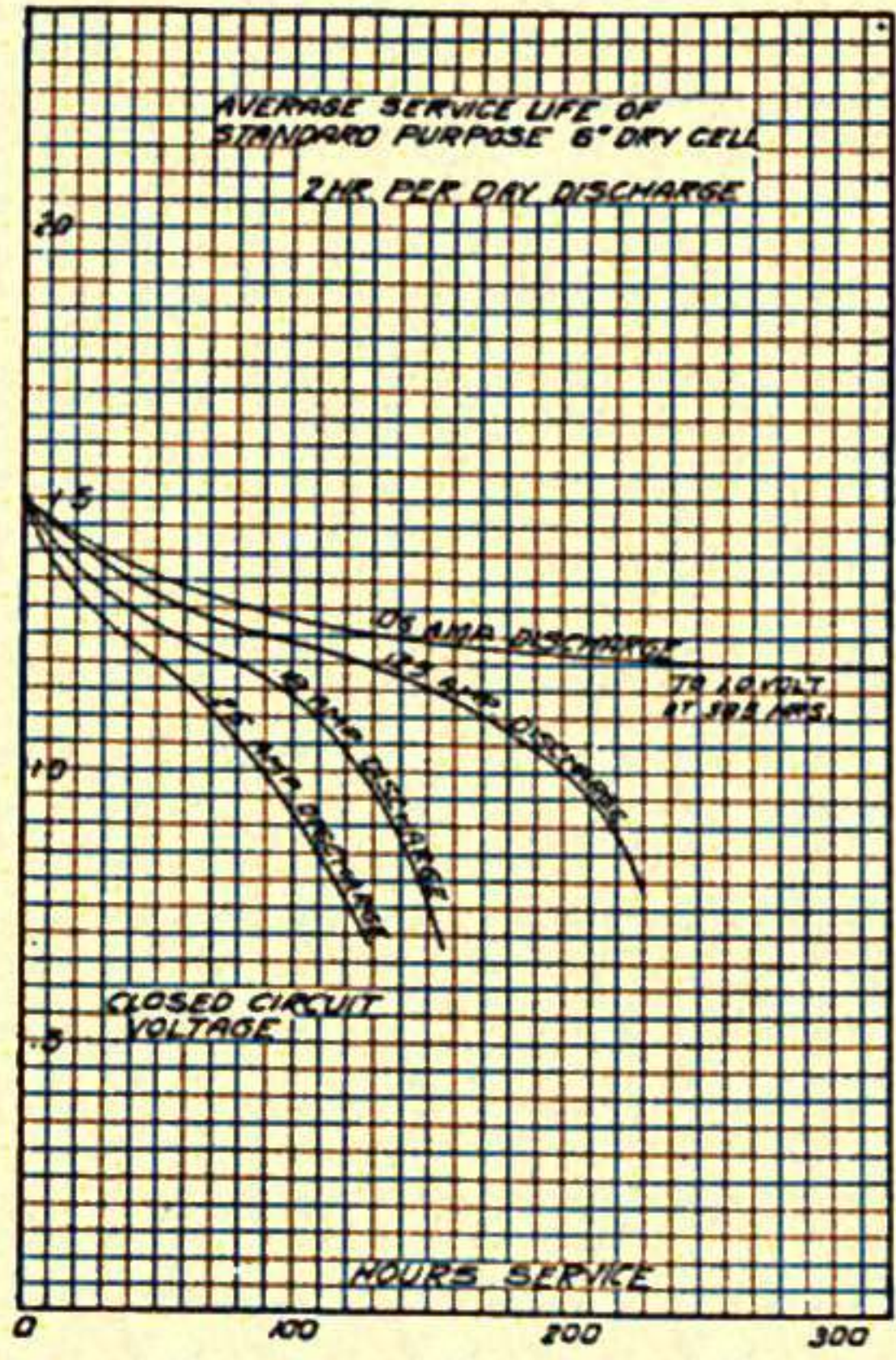

Fig. 121

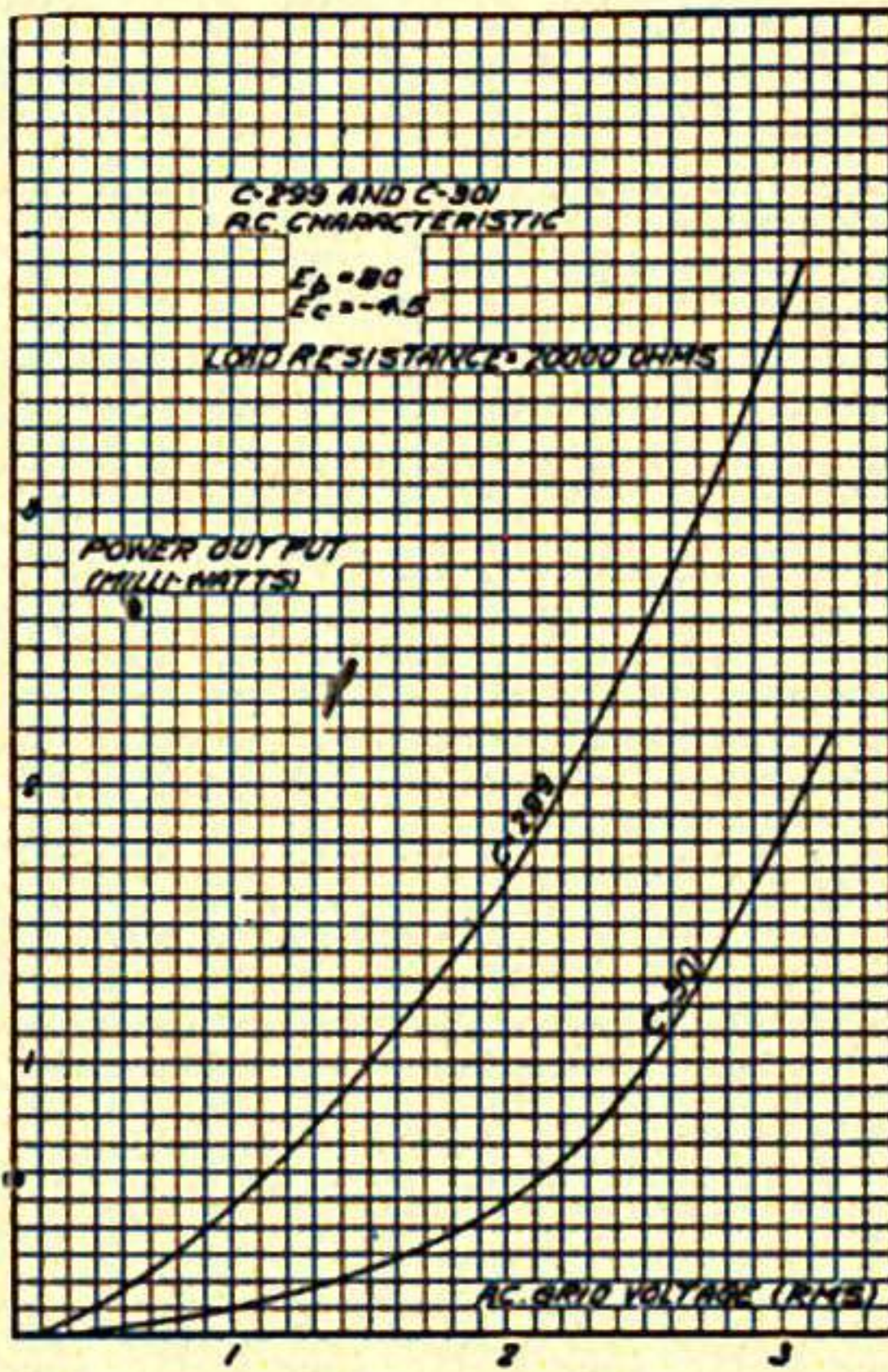

Fig. 122

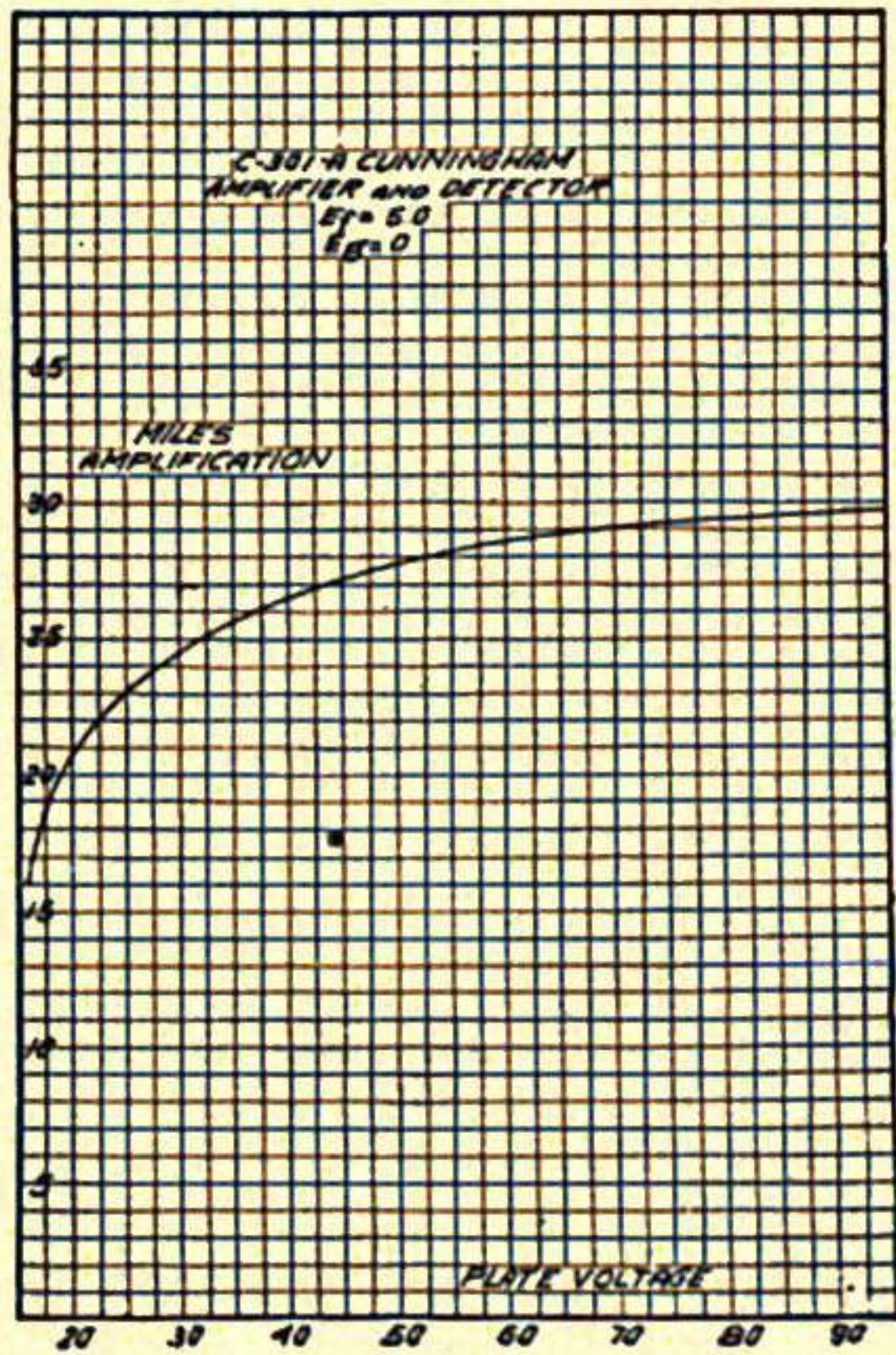

Fig. 123

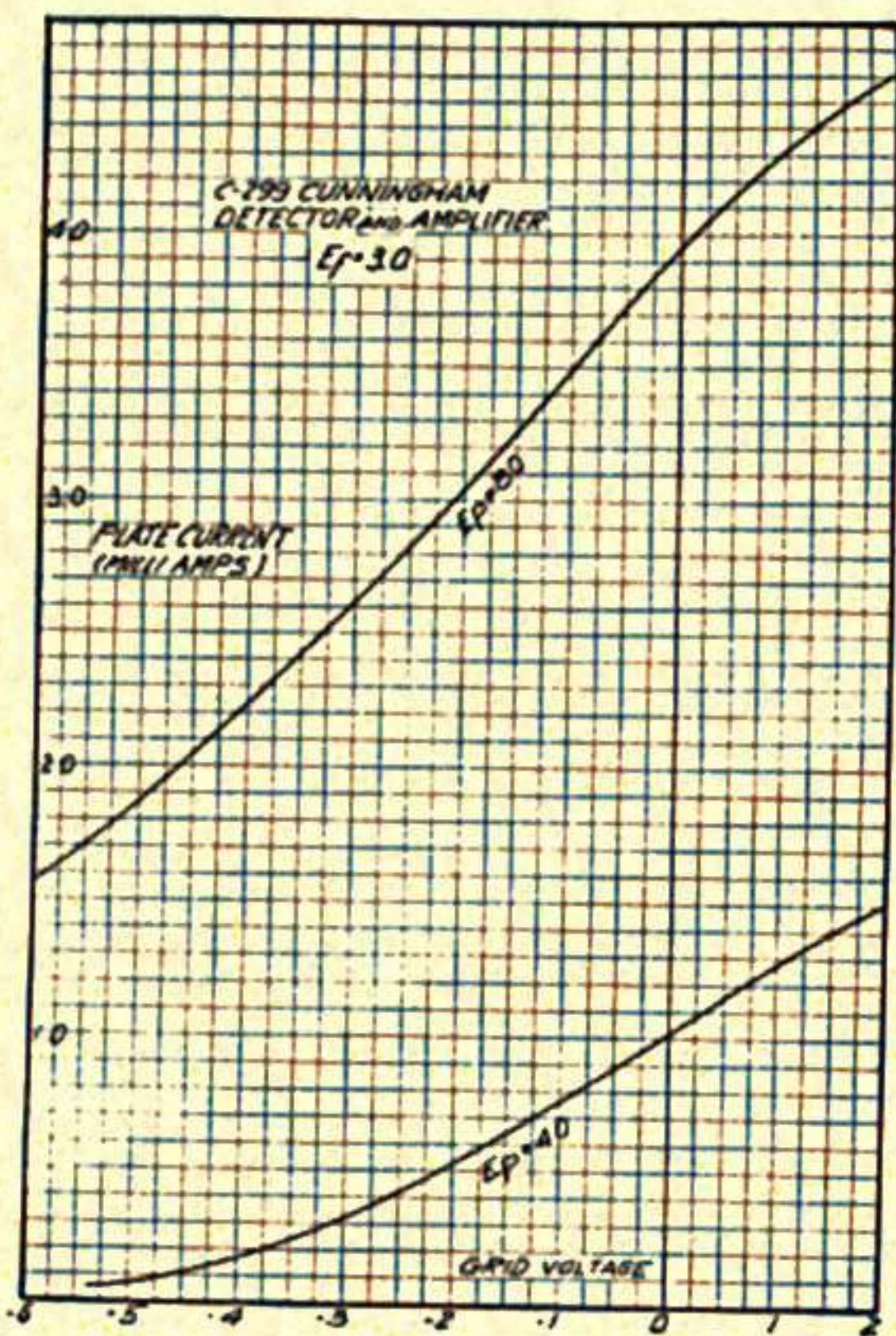

Fig. 124

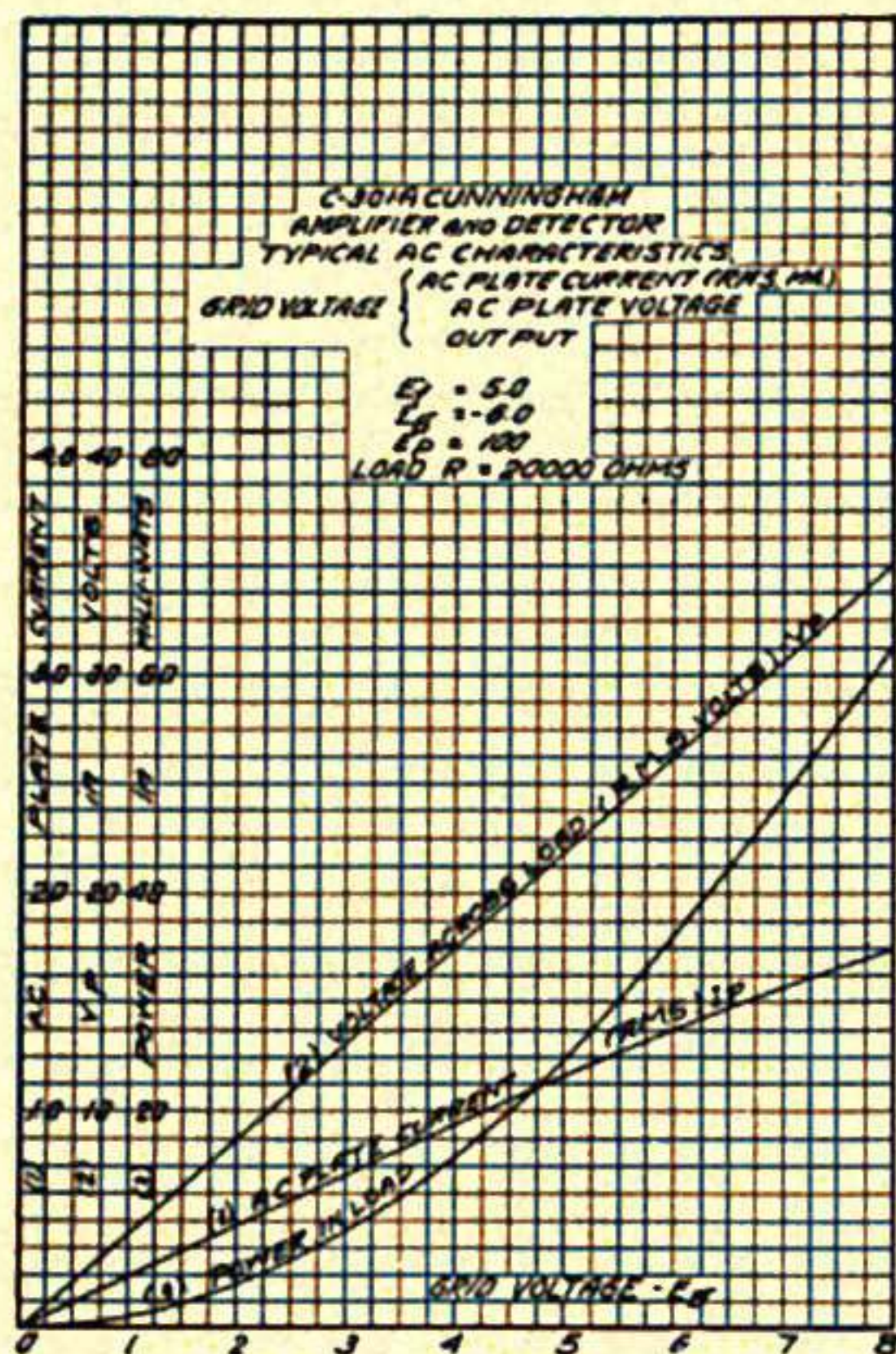

Fig. 125

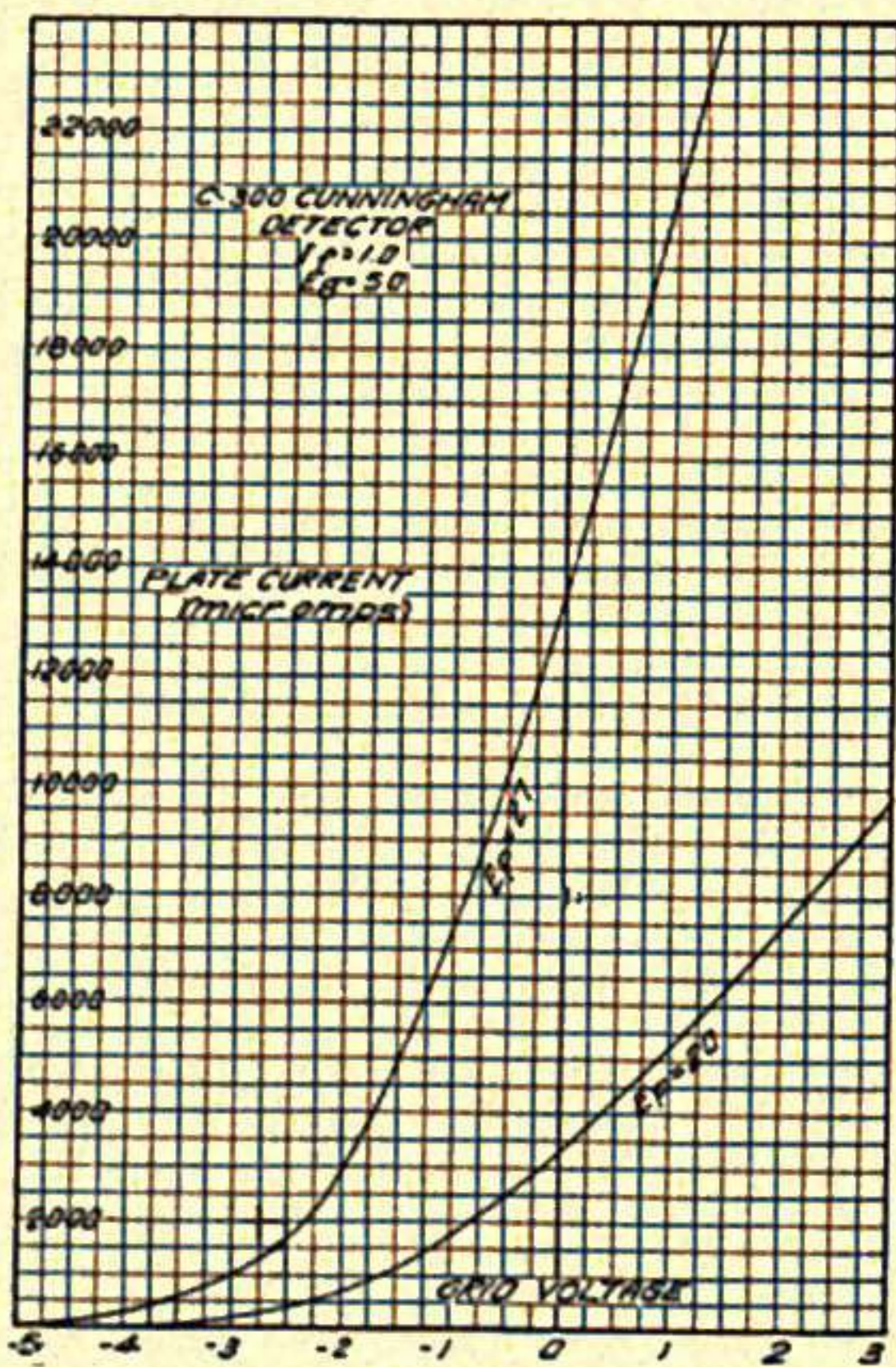

Fig. 126

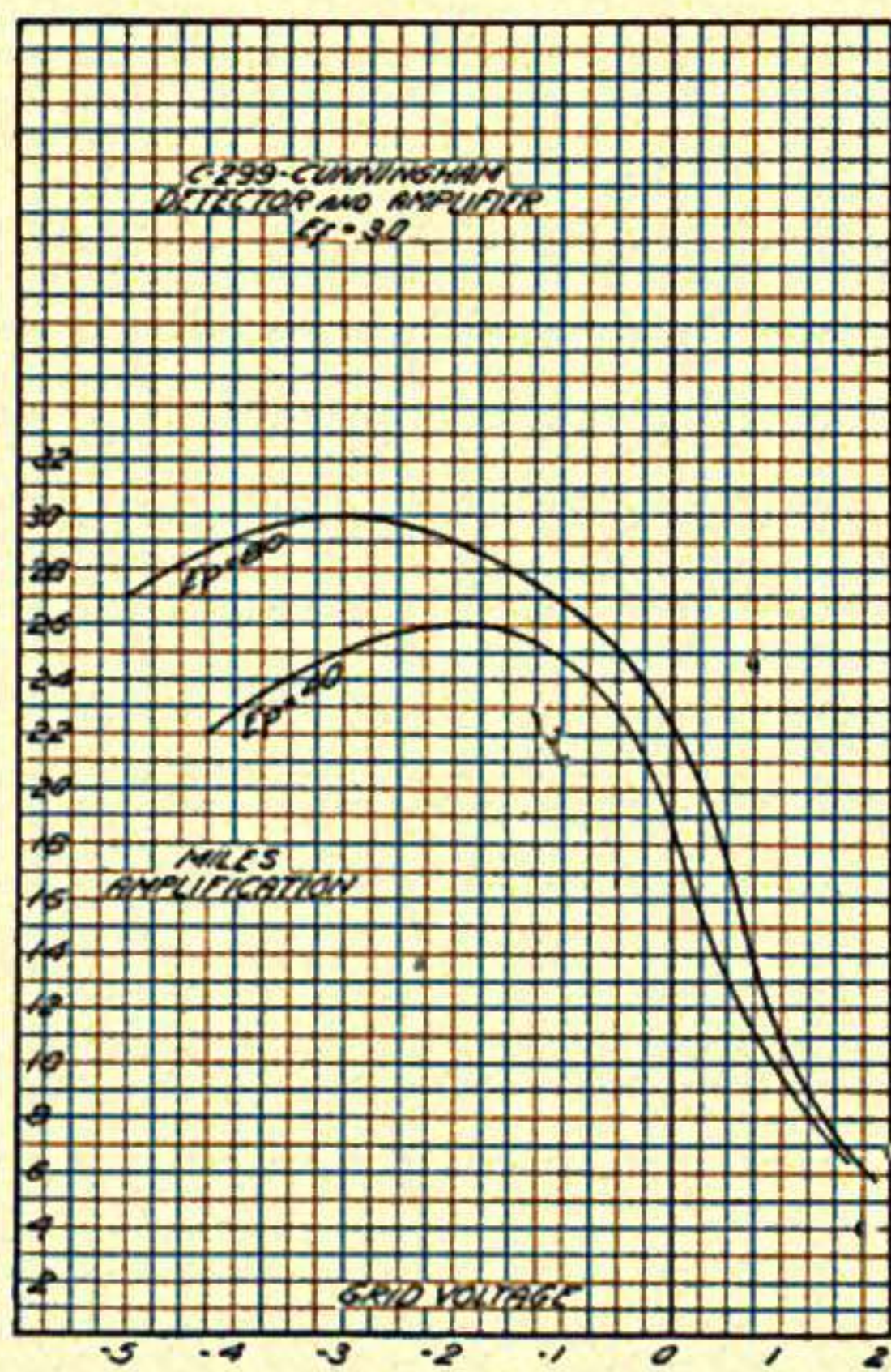

Fig. 127

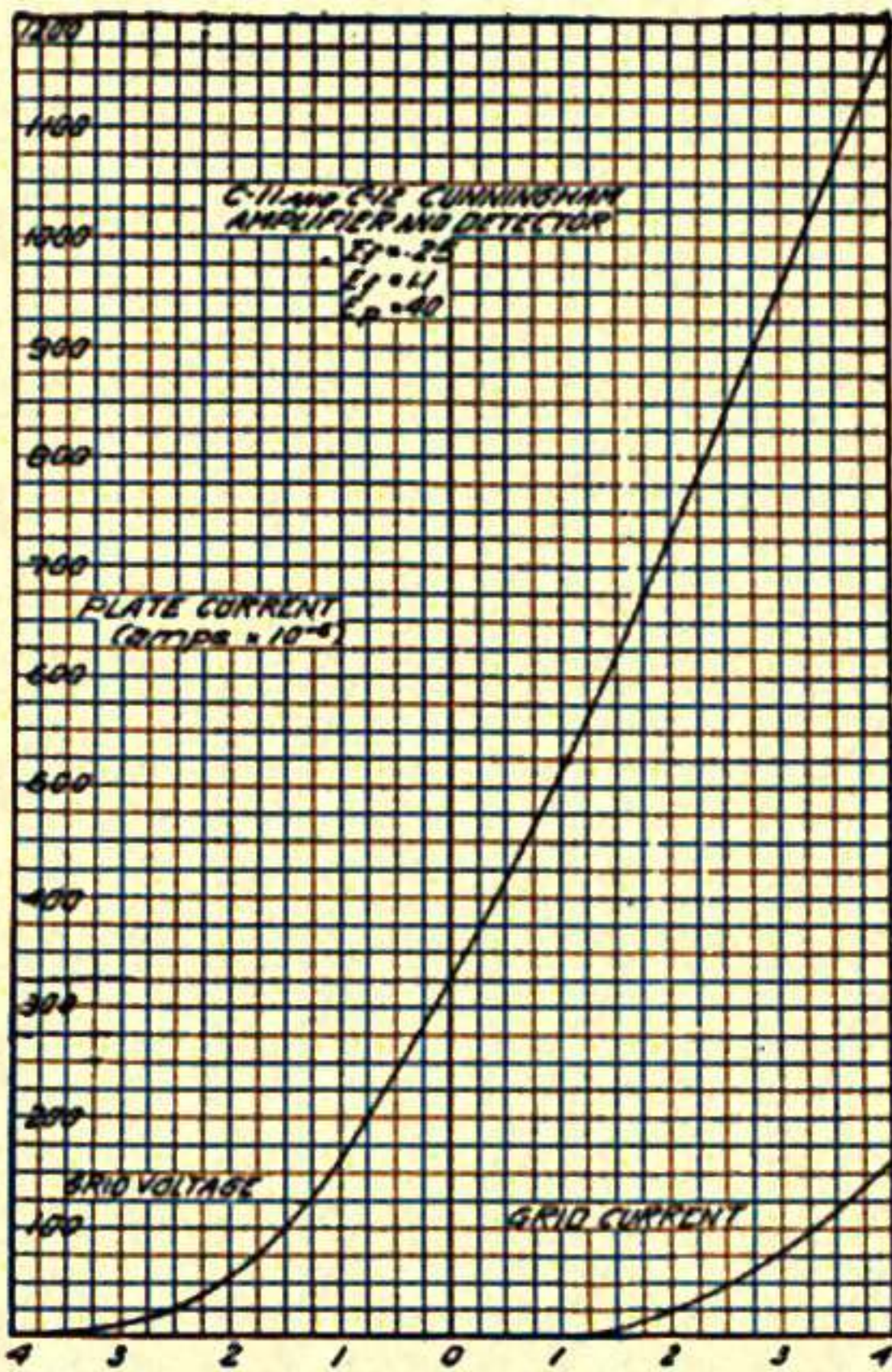

Fig. 128

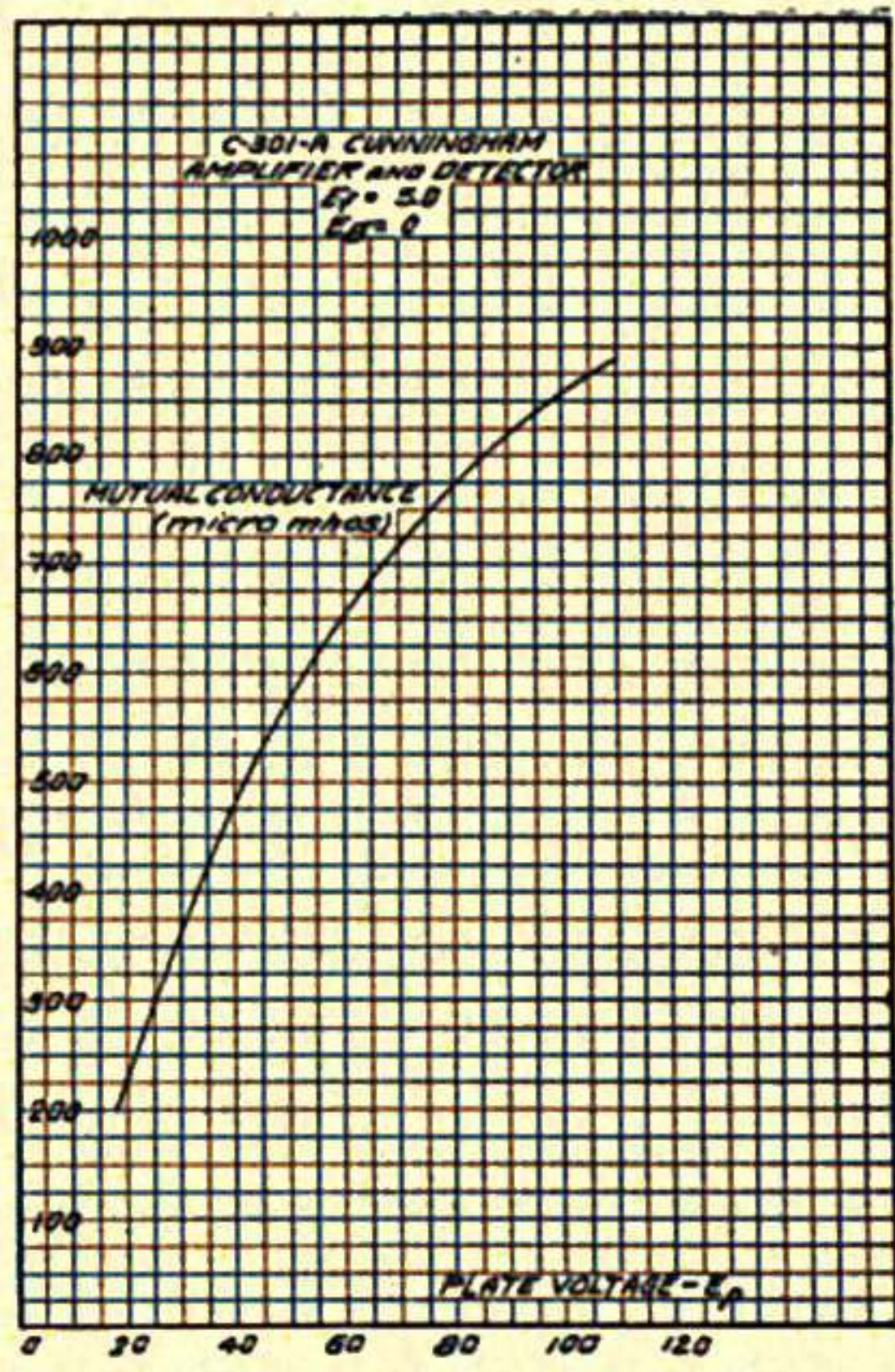

Fig. 129

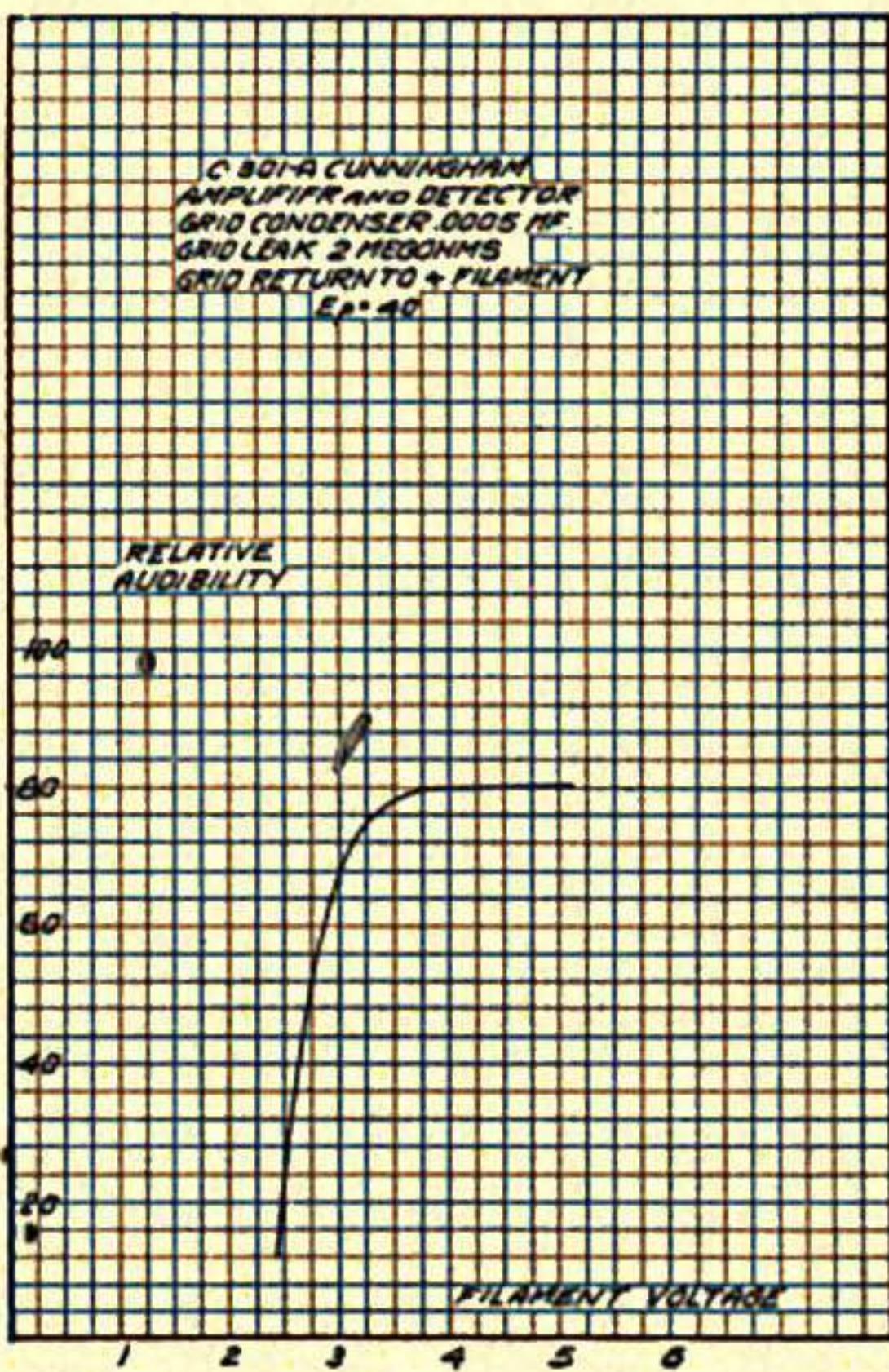

Fig. 130

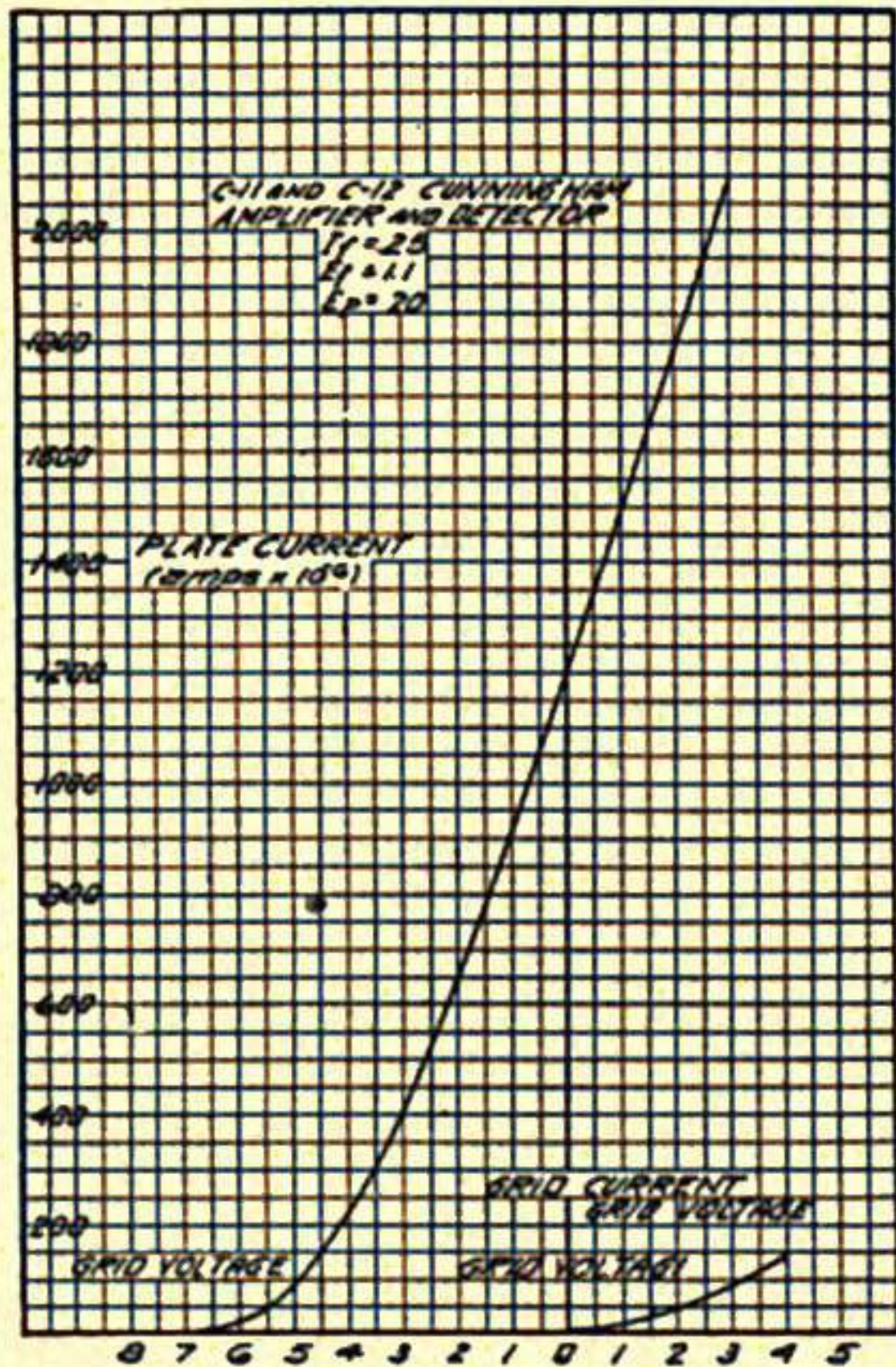

Fig. 131

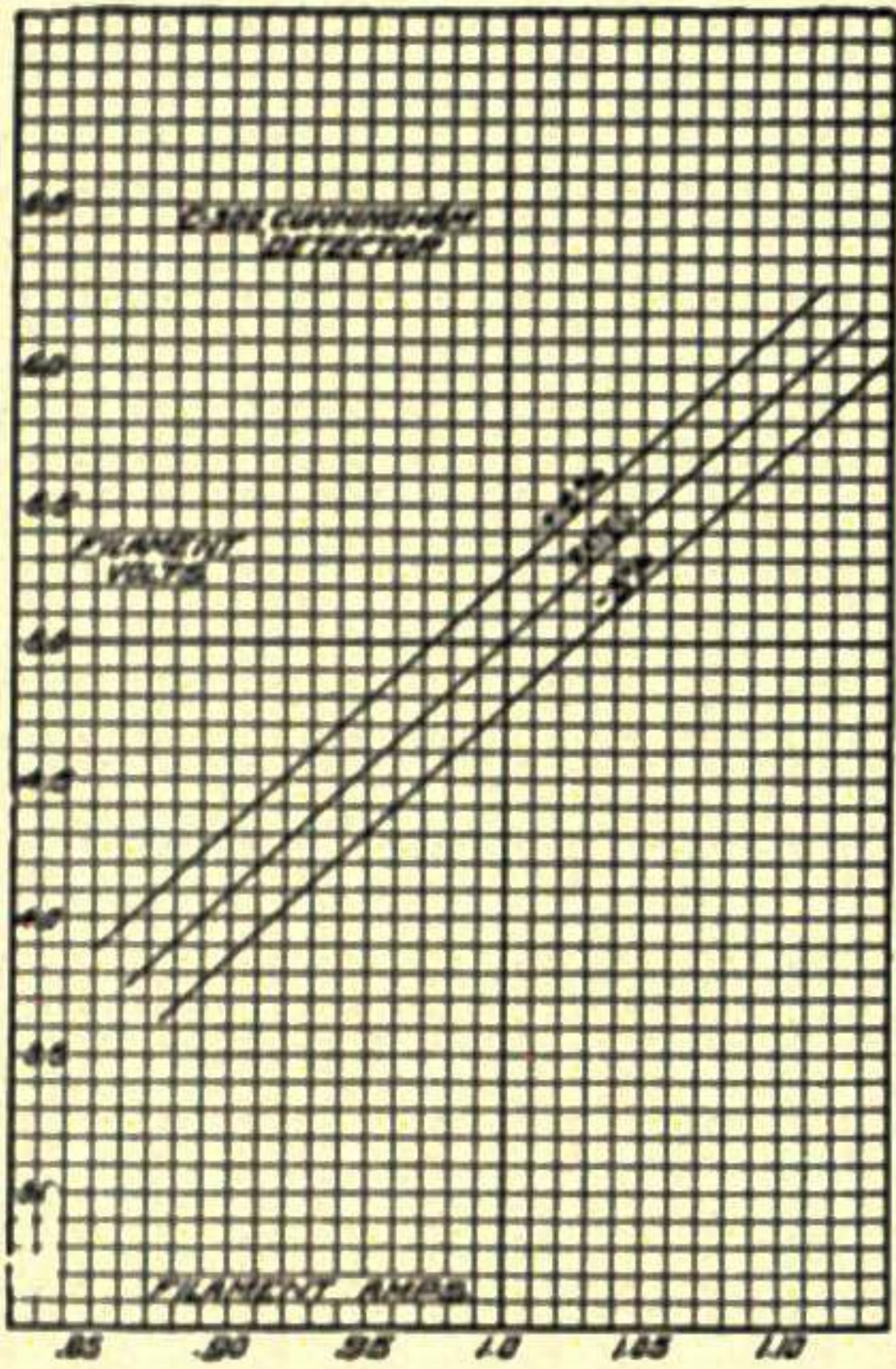

Fig. 132

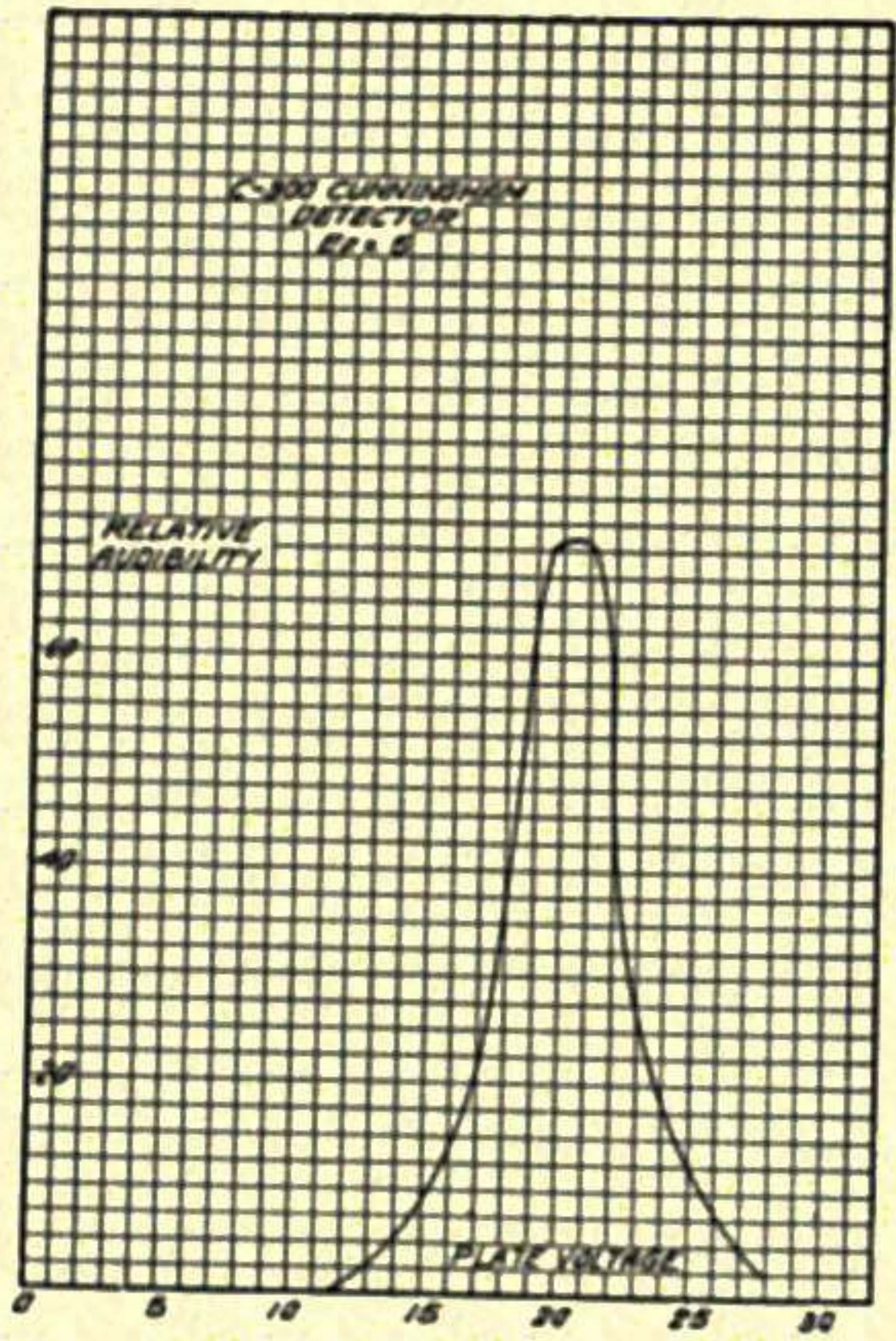

Fig. 133



Fig. 134
C-300

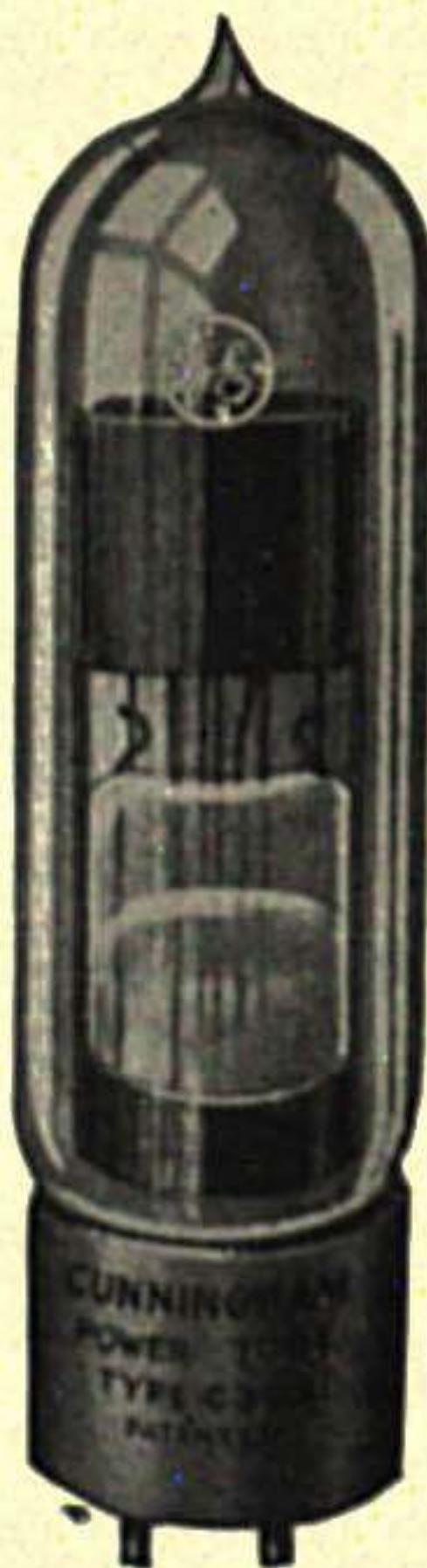

Fig. 135
C-303



Fig. 136
C-304



Fig. 137
C-302



Fig. 138
C-301 A



Fig. 139
C-12

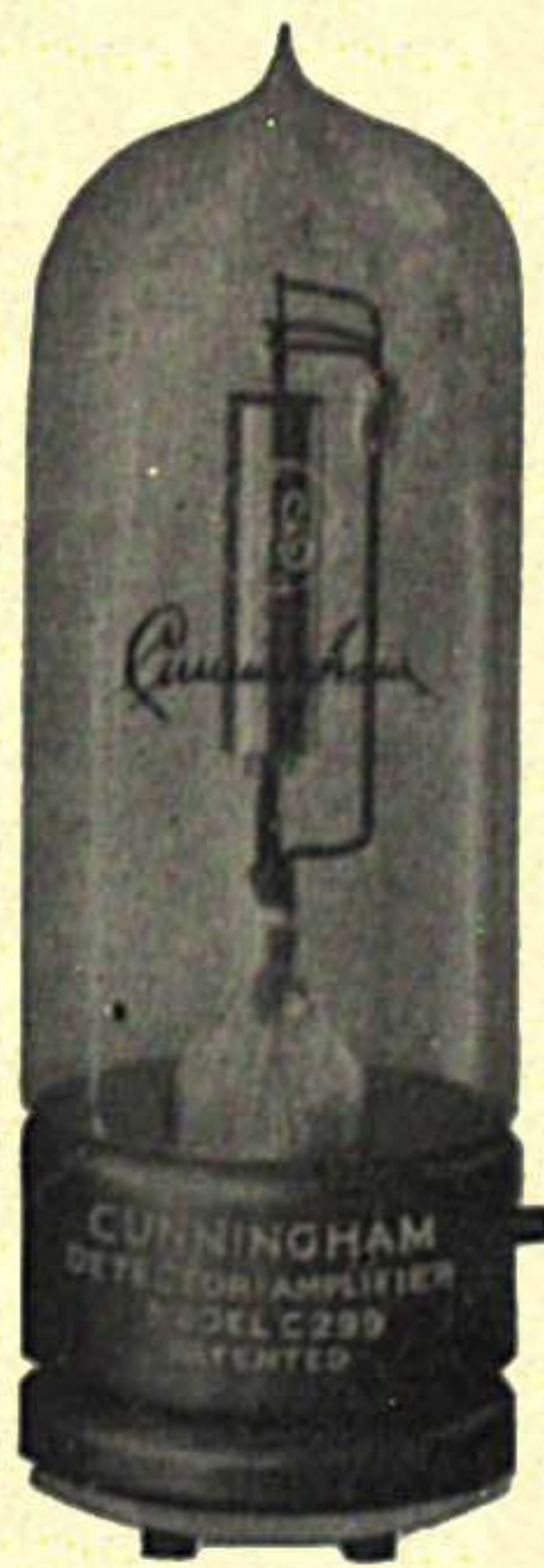

Fig. 140
C-299

TUBE CHARACTERISTICS

Radiotrons	Output		Filament Circuit Data			Plate Voltage		For Detection		Plate Impedance (Approximate) in Ohms	Amplification Constant (Approximate)	Mutual Conductance in Micro- Mhos.	Plate Current in Milliamperes (With Zero Grid)	
	Watts (Rated)		Battery Source Voltage	Filament Terminal Voltage	Filament Current	Detector	Amplifier Except Notes	Grid Leak Megohms	Grid Condenser Mfd.				Plate Voltage	Plate Current
WD-11.....			1.5	1.1	0.25	20 to 45	40 to 100 see Note (2)	2 to 3	.00025	19,000 at 40 Volts 17,000 at 80 Volts	6.5	340*	20 40 80	0.3 1.2 3.9
WD-12.....														
UV-199.....			4.5	3.0	0.06	20 to 45	40 to 100 see Note (3)	†† 2 to 9	.00025	18,500 at 40 Volts at Zero Grid 16,000 at 80 Volts with minus 4.5 Volt Negative Grid	6.25	340*	20 40 60 80	0.25 1.1 2.4 3.9
UV-200.....			6.0	5.0	1.0	15 to 23.5		½ to 2	.00025 to .0005	9,000				Detector: 0.25—1.0
UV-201-A.....			6.0	5.0	0.25	20 to 45	40 to 120 see Note (1)	†† 2 to 9	.00025	16,500 at 40 Volts at Zero Grid 12,500 at 100 Volts with minus 6 Volt Negative Grid	8.0	485*	40 60 80 90 100	1.0 2.6 4.8 6.0 7.5
UV-202.....	5		10	7.5	2.35		Oscillator 350			5,000 at 350 Volts at Zero Grid	7.5	1,500	350	50

NOTE 1 UV-201-A		NOTE 2 WD-11 AND WD-12		NOTE 3 UV-199	
Plate Voltage	Negative Grid Bias Voltage or "C" Battery	Plate Voltage	Negative Grid Bias Voltage or "C" Battery	Plate Voltage	Negative Grid Bias Voltage or "C" Battery
40	0.5 to 1.0	45
60	1.0 to 3.0	60	40	0.5 to 1.0
80	3.0 to 4.5	80 to 100	60	1.0 to 3.0
100	4.5 to 6.0	80	4.5 to 6.0
120	6.0 to 9.0	100†	6.0 to 7.5

Note: These figures on Impedance, Amplification Constant, Mutual Conductance do not apply when tube is oscillating.
 Note: All of above values are based on approximate averages taken over a long period of time. Individual tubes may vary somewhat from figures shown.
 Note: The Amplification Constant in itself is not a direct measure of the amplification given by the tube. The mutual conductance more nearly represents the amplification given in ordinary circuits.
 * Mutual Conductance Values are at 40 Volts on Plate and Zero Grid.
 †† A grid leak resistance between two and five megohms is satisfactory for average work. A resistance between five and nine megohms is somewhat better for very weak signals.

Fig. 141

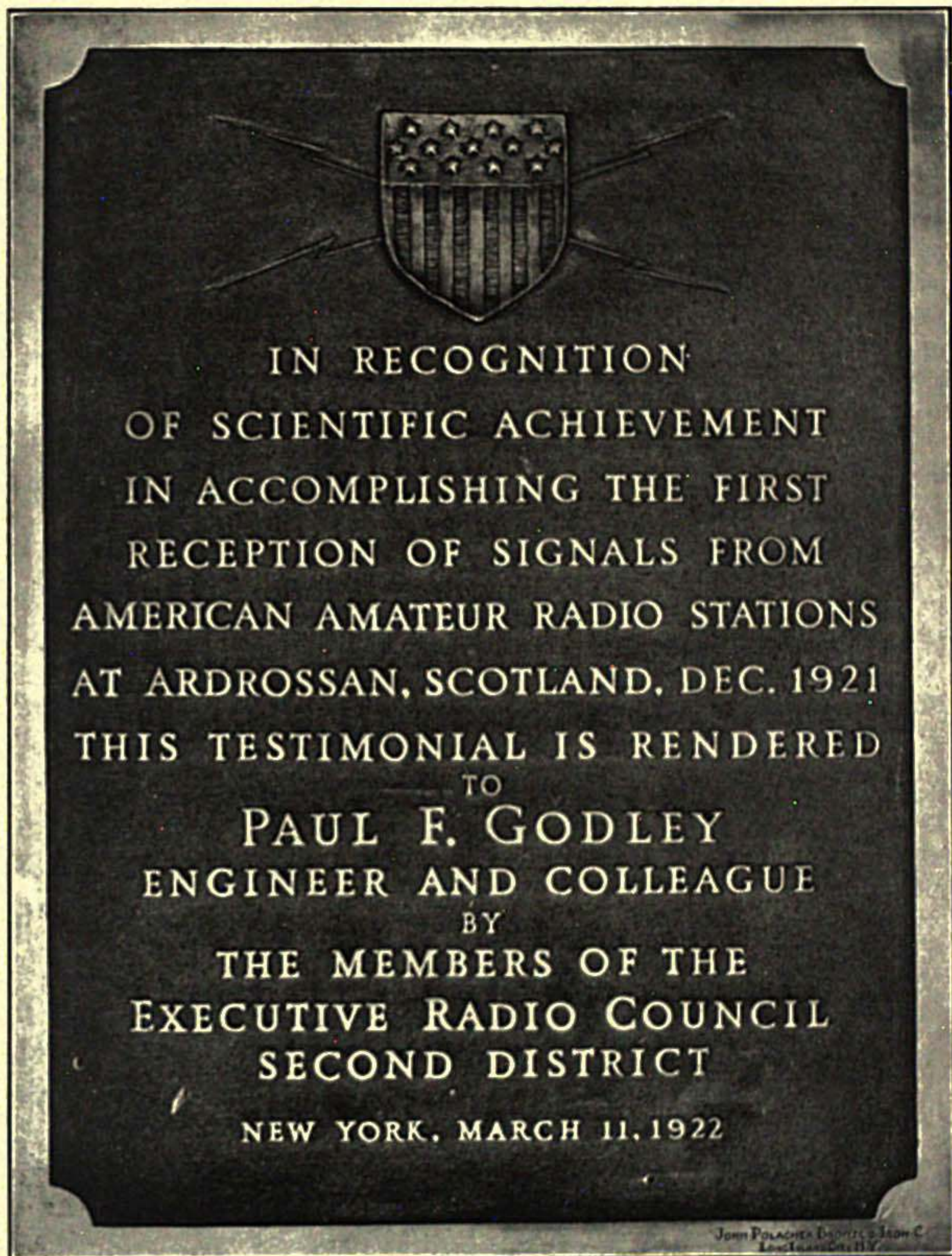

Fig. 142

Testimonial Rendered to Paul F. Godley in Spring of 1922. In Scotland Mr. Godley Used a Super-Heterodyne of His Own Design and Manufacture. Mr. Godley is Recognized as the Leading Receiving Expert in This Country.

line consists of one special gas content detector tube, three high vacuum type detector and amplifier tubes (one of which is mounted on two types of base) and three power tubes. These tubes meet every possible requirement of the broadcast listener.

The natural question follows: How shall I select the Cunningham Tube which best meets my individual requirements? What are the manufacturer's recommendations? No general recommendations can be made. A study of each individual case is necessary. What type of installation have you? What filament battery supply is available? How many tubes are you using? What is the type of loud speaker? Are you using radio-frequency amplification?

The following chart showing comparative ratings of Cunningham Radio Tubes with the appended comments is given to assist in the selection of the best type to meet your individual requirements.

COMPARATIVE RATINGS

CUNNINGHAM HIGH VACUUM RADIO TUBES

Mutual Conductance in Micromhos versus Filament Power in Watts

Type of Tube	Source of Filament Supply	Filament Power in Watts	Mutual Conductance in Micromhos		Recommended Plate Voltage		Recommended Negative Grid Voltage	
			Min.	Max.	Min.	Max.	Min.	Max.
C-301	6-volt storage battery	5.	310	400	40	100	0—1.5	1.5—3
C-301-A								
C-11	1.5-volt—single cell dry battery	.275	320	390	40	100	0—1	2—3
C-12								
C-299	4.5-volt—three cell dry battery	.18	340	410	40	90	0—1.5	3—4.5

Fig. 142A

Analyzing the possible situations under which the purchaser must decide, consideration should first be given to the radio functions to be performed.

DETECTION

Every radio tube set requires a detector and one or more amplifiers. Any Cunningham receiving tube can be used as the detector. Type C-300 is specially designed for detector action and is not recommended as an amplifier. It is the most sensitive detector in the Cunningham line, maximum audibility resulting from critical adjustment of plate and filament voltages. The gas content results in a low plate voltage, 18 to 25 volts; only a single 22½-volt B battery is necessary. If a high vacuum type tube is used selection will be determined by considerations hereinafter explained.

AUDIO-FREQUENCY AMPLIFICATION

All Cunningham tubes listed in the chart (Fig. 142A) operate satisfactorily as audio-frequency amplifiers, C-11, C-12 and C-299 having approximately equal outputs in amount slightly in excess of previous type C-301 and will satisfactorily operate any small loud speaker. Larger loud speakers can be operated by these types by using two tubes push-pull connected in the last audio stage. C-301-A is a super amplifier with approximately double the output of the other types and will readily operate all power amplifiers. Wherever extreme amplification is desired use C-301-A.

RADIO-FREQUENCY AMPLIFICATION

Types C-11 and C-12 are not recommended for this use. Selection is limited to C-301-A and C-299 as determined by filament supply considerations.

GENERAL CONSIDERATIONS

Use of the new types of tubes in sets designed for earlier types will depend principally on filament energy supply. From a radio standpoint all types are interchangeable by the use of suitable adaptors, except C-11 and C-12 in radio frequency amplifier circuits.

It is desirable to select one type of tube throughout a multi-tube set, thereby standardizing filament energy supply. However, for power amplification with minimum battery consumption, C-12 or C-299 can be used as the detector and in the preliminary stages, C-301-A being used in the auxiliary power amplifier connected to the loud speaker. Dry batteries can then be used to energize the C-12 or C-299 tubes, a 6-volt storage battery being provided for the C-301-A operation.

The large majority of sets now in use have been designed for standard based, 6-volt tubes such as C-300 and C-301, and require storage bat-

tery operation. A decided advantage can be obtained by replacing these earlier types with the new types.

Using C-301-A will reduce the current drain on the battery to one-fourth in addition to increasing the amplification. C-301-A is also extremely quiet in operation. No adaptor or change in rheostat resistance is necessary. Wherever storage battery filament supply is available and maximum amplification is desired, use C-301-A.

If it is desired to convert a standard based 6-volt set to dry battery operation C-12 or C-299 can be used. C-12 requires no adaptor and generally no change in rheostat resistance. C-299, with proper adaptor, is the more flexible tube and is considerably more economical in A battery consumption.

In sets provided with the special Westinghouse base, such as Aeriola Sr. and Aeriola Grand use C-11 for renewal. Only a slight economy in battery consumption will result from the use of C-299.

If your set has been designed for C-299, replace with that type.

In a single tube set C-11 or C-12 offers the advantage of minimum filament battery investment and bulk—only a single No. 6 dry cell is required. C-299 in a single tube set requires three dry batteries to energize the filament but as an offset is approximately 33 1/3 per cent more economical.

C-299 is the most economical radio tube ever developed. It is also extremely compact and functions perfectly as a detector or in radio or audio frequency circuits. It is truly the ideal dry battery tube.

There are three transmitting tubes, types C-302, C-303 and C-304. All of these tubes have been designed to give efficient operation in a transmitting set either as speech amplifiers, modulators or oscillators. The only difference in the three types is their power output, which necessitates considerable difference in size and manner of construction.

The C-302 is a 5-watt power tube, extensively used by amateurs for both telegraphy and telephony. It is specially recommended for use in small transmitting sets where low initial costs and low operating costs are desirable features.

The C-303 is a 50-watt power tube, and is largely used for amateurs who desire considerable power for telephone work, or for long distance telegraphy. For the experimenter or amateur desiring heavy power output from a single tube, type C-304, a 250-watt power tube, can be used.

INSTRUCTIONS FOR THE USE OF RECEIVING TUBE CHARACTERISTICS

And An Explanation of the Terms Used in Connection With Vacuum Tube Operation

Each of the characteristic curves shown in this book are graphic illustrations of some particular phase of vacuum tube action. For ease in reading values curves are plotted on a cross section sheet. The horizontal axis is arbitrarily subdivided into units of one variable factor, such as grid voltage, plate voltage, filament voltage, etc. For convenience these may be called the controlling factors. The horizontal axis is divided into units of the resulting factor. In each case all of the other values of voltage and current in the various circuits of the tube are definitely established and remain constant. In each case the curve illustrates the effect of the current or voltage in one particular circuit of the tube upon one other definite factor, such as current, voltage, impedance, or audibility.

Throughout the book certain letter symbols are used, to represent the various circuits of the vacuum tube and also the electrical constants of the circuit. These symbols and their meanings are as follows:

E = Electromotive force or voltage.

I = Current or amperage.

a or f = Filament circuit of the tube.

b or p = Plate circuit of the tube.

c or g = Grid circuit of the tube.

Z = Impedance.

μ = Amplification constant.

From this it is easy to see that the expression " $E_f = 5$ volts," means that the filament terminal potential of the tube is 5 volts. In the same way the expression " $E_c = -6$ volts," means that the grid has a negative potential of 6 volts with respect to the filament.

It is customary to plot tube characteristics such as the plate voltage-plate current, and plate voltage-plate impedance curves at zero grid potential. The curves in this book are all plotted in this manner, although it does not represent the usual condition of operation since a negative grid bias is ordinarily required. However, it is not necessary to plot additional curves for each value of grid voltage since within the limits of grid and plate voltage, ordinarily used, it is possible to calculate approximate values from the curve made at zero grid voltage. This

is due to the fact that applying a certain voltage to the grid has practically the same effect in the plate circuit as applying to the plate the same voltage multiplied by the amplification constant of the tube. It is then only necessary to find the equivalent plate voltage and make use of the curve drawn for zero grid voltage.

For example—Suppose that it is desired to find the plate current, plate impedance and mutual conductance of a C-301-A at 100 volts plate, and — 4.5 volts grid potential. Fig. 103 shows that the amplification constant at 100 volts plate and zero grid voltage is 8.1. For most purposes this value of amplification constant is sufficiently accurate for use in the remainder of the example, but for extreme accuracy a second approximation may be made. Thus 8.1 being the amplification constant, the equivalent plate voltage is found to be $100 + (8.1 - 4.5) = 63.55$. For this value of plate voltage the amplification constant is found to be 8, and from this the new value of equivalent plate voltage is $100 + 8 \times (-4.5) = 64$ volts. This refinement is only necessary in cases where extreme accuracy is desired, and the first value of 63.55 volts will generally be sufficient for the remainder of the example.

With 64 volts as the plate voltage it is found from the plate impedance curve in the same figure, that the plate impedance is 12,000 ohms. From Fig. 129 it will be seen that the mutual conductance at 64 volts is about 680 micromhos. In the same manner Fig. 111 shows the plate current to be 2.05 milliamperes.

For all practical purposes these readings taken from the curves with a plate potential of 64 volts may be considered correct for a plate potential of 100 volts and a negative grid bias of 4.5 volts. It is, however, obvious that the above method decreases in accuracy as the grid voltage, times the amplification constant, approaches the plate voltage.

AN EXPLANATION OF AMPLIFICATION

One of the most important uses of the vacuum tube is to amplify or increase the intensity of electric currents. Tubes of certain design are specially adapted to this purpose. These tubes are called "amplifier tubes." The single word "amplifier" generally refers to the combination of an amplifier tube and the necessary associated circuits to produce amplification.

Such an amplifier is most readily understood if looked at as a telephone repeater, that is, a device capable of receiving telephone currents and giving out other telephone currents of the same wave form but of greater magnitude. The increased energy in the output circuit is sup-

plied by the plate or "B" battery. In this manner the voice or music currents are amplified or built up without distortion.

Electric currents at both voice frequency and radio-frequency are often amplified as many as ten or twelve times between the microphone in the studio and the sound reproducing device of the receiving set.

THE USE OF THE TERM MILES IN THE MEASURE OF AMPLIFICATION

Since amplification plays such an important part in both radio transmission and reception it is obviously necessary that there be some convenient unit for measuring the amount of amplification between the input and output of an amplifier.

For many years prior to the advent of the vacuum tube, transmission losses in telephone lines were measured in terms of the mile of standard No. 19 gauge cable at a frequency of 796 cycles. When the vacuum tube came into use as a telephone repeater this same unit was adopted as the standard for measuring repeater or amplifier gains.

If a circuit is said to have an amplification of 25 miles, it means that it would take 25 miles of standard No. 19 gauge telephone cable to reduce the signal to its original value.

In an amplifier circuit the terms "power amplification," "current amplification" and "voltage amplification" are also used. These terms express the ratio of power, current or voltage delivered from the amplifier to the power, current or voltage received by the amplifier.

The gain in miles always depends directly on the power amplification, a given ratio between input power to the amplifier and output power from the amplifier always corresponding to the same number of "miles gain."

In a well designed amplifier circuit both the current and the voltage amplification ratio will be equal to the square root of the power amplification ratio. Under these conditions it is most convenient to think of the gain in miles as depending on the current ratio. This makes it possible to get a fairly accurate comparison between gain in miles and the increase in audibility or sound intensity, since within certain limits, depending on the mechanical construction of the sound reproducing device, sound intensity is directly proportional to current.

The table Fig. 142B shows current or audibility ratios and power ratios for gains between 1 and 30 miles of standard cable.

Miles of Standard Cable or Audibility	Current Ratio	Power Ratio	Miles of Standard Cable or Audibility	Current Ratio	Power Ratio
1	1.11	1.24	16	5.71	32.7
2	1.24	1.54	17	6.94	40.7
3	1.38	1.92	18	7.11	50.6
4	1.54	2.39	19	7.92	62.8
5	1.72	2.97	20	8.83	78.3
6	1.92	3.70	21	9.84	97.4
7	2.14	4.60	22	11.0	121.1
8	2.39	5.72	23	12.25	150.7
9	2.66	7.12	24	13.65	187.1
10	2.97	8.85	25	15.2	233.4
11	3.31	11.02	26	17.0	289.8
12	3.70	13.7	27	18.9	359.8
13	4.12	17.0	28	21.1	447.8
14	4.49	21.1	29	23.5	559.2
15	5.12	26.37	30	26.3	693.5

Fig. 142B

AMPLIFICATION CONSTANT

The amplification constant of a tube is a factor that expresses the maximum voltage amplification it is possible to obtain with that tube. If a tube such as the C-301-A has an amplification constant of 8, it is possible to obtain a maximum voltage amplification from that tube of 8 times.

MUTUAL CONDUCTANCE

The mutual conductance of a vacuum tube gives a measure for the controlling effect of the grid potential on the plate current. Since all vacuum tube circuits involve the use of grid potentials to control plate current this is a very important unit and expresses very accurately the degree of merit of the tube when used as amplifier, detector or oscillator. It is always desirable to have the mutual conductance as high as possible. A high mutual conductance means that small variations in grid potential will cause relatively large variation in plate current.

The mutual conductance of any tube can be computed directly from the plate impedance and the amplification constant. The unit of conductance is the mho. It is too large a unit for convenient use in vacuum tube work, and for this reason mutual conductance of tubes is generally expressed in micromhos. 1 mho = 1,000,000 micromhos.

$$G_m = \frac{\mu \times 1,000,000}{Z}$$

Z

where G_m = mutual conductance in micromhos, μ = amplification constant, Z = plate to filament impedance.

GRID BATTERY

The use of a negative grid potential in amplifier circuits is a very important factor in obtaining the greatest possible amplification without distortion and at minimum plate current.

The necessary grid potential depends upon the type of tube and the condition under which it is used, and varies from zero to 9 volts negative. In order to obtain this negative grid potential a battery is placed in the grid circuit at the point where the grid return is connected to the negative filament terminal with its negative terminal on the grid side in the manner illustrated in Fig. 96.

This battery is commonly referred to by several different names, grid bias battery, negative grid battery, or C battery. The symbols used to indicate grid potential are E_g or E_c , E standing for electromotive force, g for grid, and C for "C circuit," the grid circuit often being referred to as the C circuit of the tube.

The importance of using the proper negative grid potential in an amplifier circuit is clearly illustrated in a number of curves of C-299 and C-301-A. As an illustration, consider Fig. 102. Take the point on the bottom index, which represents a filament terminal potential of 3 volts. Follow the vertical line from this point upward until it intersects the first curve marked " $E_p = 40, E_g = \text{zero}.$ " Following the horizontal line from this point of intersection to the left hand index, we read a gain of 18.75 miles. For ease in explanation we shall consider this as being 19 miles. This reading represents the gain obtained with a plate potential of 40 volts, zero grid potential and a filament terminal potential of three volts. Following the three-volt vertical line on up until it intersects the third curve marked " $E_p = 40, E_g = 1.5,$ " and again reading the corresponding figures in the left hand index, we obtain a reading of 26 miles gain. Now refer to the table Fig. 142B. This table shows that a 19-mile gain represents a current ratio of 7.92, and that a 26-mile gain represents a current ratio of 17. Thus an increase in gain of 7 miles between 19 and 26 miles represents an increased current ratio of 2.14 times.

As previously explained, current ratio is also the ratio of relative audibility, so, when using a C-299 tube with 40 volts on the plate, and a

filament terminal potential of 3 volts, the use of a 1.5-volt negative grid potential more than doubles the audibility.

In addition to this important benefit the use of negative grid potential gives better tone quality, eliminates distortion at heavy loads, and reduces the total direct plate current, thereby increasing the active life of the B-battery. Examination of Fig. 98 shows that the plate current at 3 volts filament terminal, 40 volts plate and zero grid potential is 1.15 milliamperes. The application of 1.5 volts negative grid potential is equivalent to reducing the plate voltage by an amount equal to the amplification constant, times the grid potential. Considering the amplification constant of the C-299 to be 6.5, we can subtract approximately 10 volts from the plate potential. Taking a plate current reading at 30 volts from the same curve, we find it to be .65 milliamperes—about half its original value.

CUNNINGHAM DRY BATTERY TUBES TYPES C-11 and C-12

C-11, has an oxide coated platinum filament rated at 1.1 volts and .25 amperes. This is a power consumption of .275 watt. Base is a special Westinghouse type, permitting direct use in Aeriola, Sr., and Grand Receivers.

C-12 is the identical tube mounted on the standard navy base, similar to types C-300 and C-301-A, permitting its direct use without adaptors in sets equipped with standard sockets. In such cases, of course, proper supply voltage must be provided. In operation great care should be taken to prevent overheating the filament, as excessive fila-

SPECIFICATIONS

Filament Terminal Voltage.....	1.1 V.
Filament Supply Voltage.....	1.5 V.
Filament Current.....	.25 Amps.
Filament Power275 Watts.
Plate Voltage	20 to 100 Volts.
Plate Current	1 to 4 Milliamperes.
Amplification Constant	6
Mutual Conductance	320 Micromhos, at 40 volts plate and zero grid potential.
Dimensions (over-all)—C-11	1½" x 4½".
Base—C-11	4 Prong Special.
Base—C-12	4 Prong Standard.

ment current will greatly shorten the active life of the tube. A rheostat having a maximum resistance of at least 5 ohms should be used. This is approximately the resistance of the rheostat in most sets designed for standard six-volt tubes. C-12 can thus be used in such sets without making any changes other than reducing the filament supply potential to $1\frac{1}{2}$ volts.

Fig. 121 shows the hours of service obtainable with standard No. 6 dry cells when used at various discharge rates. The curve marked "25. ampere discharge" shows the hours of service obtainable from a standard battery when used with C-11 or C-12 two hours a day. The useful life of the battery which extends over the range from 1.5 to 1.1 volts is about eighty hours.

In sets using more than one tube a battery must be used for each tube. The filaments of this type of tube are carefully checked before leaving the factory, to ensure that the current readings are uniform at a given voltage. This permits the satisfactory operation of the tubes in parallel. When two or three tubes are used in the set the two or three dry batteries may be connected in parallel and controlled by a single rheostat.

C-11 and C-12 are very satisfactory for use both as detectors and audio-frequency amplifiers, but are not recommended as radio-frequency amplifiers. Their greatest application is in single or two tube sets, as the A battery need consist of only one or two dry cells. In sets using radio-frequency amplification or a greater number of tubes type C-299, is recommended.

C-11 or C-12 functions as a detector in the standard detector circuit employing a grid condenser and grid leak. The grid return should always be connected to the positive filament terminal, as illustrated in Fig. 97. The values of the grid leak and grid condenser are not critical. A grid^ocondenser of .00025 mfd. and a grid leak of from two to five megohms are recommended. These are the approximate values of grid leak and grid condenser most generally employed in standard receiving sets, and it will not be necessary to make any changes in their values when using C-12 in such sets. The normal plate potential for use as a detector is 20 volts, but higher potentials up to 40 volts may be used with slightly improved results, if such potential is available, due to the use of an amplifier.

• As an audio-frequency amplifier sufficient output can be obtained for the operation of small loud speakers using plate voltages between 40 and 100. The grid return should always be made to the negative filament terminal between the rheostat and the A battery. This gives the

grid a sufficient negative potential for operation at a plate potential of 40 to 50 volts. For operation with plate potentials between 60 and 80 volts an additional negative grid potential will be necessary, and a 1½-volt flashlight battery should be connected into the circuit in the manner shown in Fig. 96. If the plate voltage is between 80 and 100 use a 3-volt C battery.

The plate impedance of C-11 and C-12, as illustrated in Fig. 99, are sufficiently close to that of other standard tubes to permit the use of amplifying transformers designed for tubes such as C-300, C-299 and C-301-A, without the introduction of losses or distortion.

Figs. 131, 128 and 107 illustrate variation of plate current with respect to grid voltage at plate potentials of 20, 40 and 80 volts respectively.

CUNNINGHAM DRY BATTERY TUBE TYPE C-299

C-299 is a highly efficient dry battery tube, with a new patented low temperature filament, designed for use as a detector and amplifier. The vacuum is extremely high, making this tube very quiet in operation and eliminating the necessity for critical adjustment of plate and filament potential.

It is considerably smaller than all other models of Cunningham tubes and is mounted on a special base, the advantages of which are simplicity of wiring, low capacity between terminals and compactness.

As regards operating characteristics C-299 is interchangeable with all other types of Cunningham tubes. It may be used in sets designed for any previous type of tube if suitable adaptors are employed, and the correct filament voltage and rheostat resistance are used.

It is the properties of the special filament that makes this tube so very efficient. Its diameter is approximately one-fourth that of the average human hair, and the current consumption is 60 milliamperes at 3 volts, which means a power consumption of only .18 watt. This is less than the power consumed in the plate circuit when the tube is being used as an amplifier with a plate potential of 80 volts and the proper negative grid potential, a result not previously attained in any radio tube.

C-299 becomes highly discolored in the process of evacuation. This discoloration has absolutely no effect on the operating characteristics of the tube and does not in any way indicate its merit or the kind of filament material used.

SPECIFICATIONS

Filament Terminal Voltage.....	3 V.
Filament Supply Voltage.....	4.5 V.
Filament Current06 Amps.
Plate Voltage	20 to 80 V.
Plate Current	1 to 4 Milli-amps.
Amplification Constant	6.5
Mutual Conductance	340 micromhos at 40 volts plate and zero grid potential
Mutual Conductance	410 micromhos at 90 volts plate and 4.5 volts negative grid po- tential
Dimensions (over-all)	1" x 3½"
Base	4 Prong Special

Failure of C-299 is seldom due to actual burn out of the filament unless excessive voltage is applied. The end of its useful life is indicated by a decrease in the electron emission from the filament or by the necessity of using an increased filament terminal potential in order to obtain satisfactory results.

For the general purposes the filament current of these tubes should be supplied from three standard No. 6 dry cells in series with a suitable rheostat. From two to five tubes may be operated in parallel from a single set of three batteries in series, although six dry cells connected in series parallel will prove more economical when more than three tubes are used.

Filament current is not a critical factor in the operation of this new tube. It is only important that it is not allowed to exceed the rated value of 60 milliamperes. For this purpose the ordinary rheostat as used for C-300 and C-301-A does not have sufficient resistance. For a single tube used with a 4½-volt supply the filament rheostat should have a resistance of 30 ohms. For two tubes in parallel the total resistance of the rheostat should be at least 20 ohms, and when using 3, 4 or 5 of these tubes in parallel a single rheostat having a maximum resistance of 10 ohms may be used.

When extreme compactness and lightness is desired smaller batteries of the flashlight type may be used for filament lighting for a short period of time. In such cases a battery should be supplied for each tube used. All batteries may be connected in parallel and their output controlled by a single rheostat.

The output of the C-299 is sufficiently great to permit its use in the last stage of audio frequency amplifier circuits designed for the operation of small loud speakers. For greater output two C-299 tubes connected for push pull operation can be used in the last stage. When used as an amplifier it is extremely important to have the filament rheostat in the negative filament lead and to have the grid return made to the negative side between the negative battery terminal and the rheostat instead of between the rheostat and the filament terminal as has sometimes been done in the past. These connections which are illustrated in Fig. 96 provide a negative bias for the grid of the tube which is sufficient for all plate potentials up to 40 volts. For obtaining maximum efficiency in operation, maximum life from the B battery, and freedom from distortion, this negative potential should be increased with an increase in plate voltage. The following table gives an approximation of the grid bias voltages necessary at various plate voltages:

Plate Potential	Required Negative Grid Potential
40 Volts.....	0.5—1.0 Volt
60 Volts.....	1.0—3.0 Volts
80 Volts.....	3.0—4.5 Volts
100 Volts.....	4.5—6.0 Volts

For this purpose dry cells, such as are commonly used in the small type of flashlight, should be satisfactory, although the use of the larger type of flashlight batteries will be more economical.

This tube is an extremely good detector and when used in that capacity the grid return should be made to the positive side of the filament in the manner illustrated in Fig. 97. Critical adjustment of the grid leak and grid condenser are not required, but it is recommended that a condenser of approximately .00025 mfd. and a grid leak of from 2 to 5 megohms be used. These are the approximate values of grid condensers and grid leaks now used in the detector circuits of standard sets designed for the C-300 and C-301-A. This tube will, therefore, work satisfactorily in such sets without making any changes in the values of these parts. Best results will be obtained with a plate potential of 40 volts, although very satisfactory detector action can be obtained with a single 22½-volt battery for plate supply. Never apply a potential of over 40 volts to the plate when the tube is used as a detector. Higher plate voltages will cause excessive plate current shortening the active life of the B battery.

OPERATING CHARACTERISTICS

The life of dry batteries is proportional to the current drawn from them, and also to the length of time they are used for a continuous period. The four curves in Fig. 121 illustrate the hours of service obtainable from a standard No. 6 dry cell, used two hours a day, for the purpose of lighting one, two, three or four C-299 dry battery tubes. The curve for the .25-ampere discharge rate is also representative of the life obtainable from a single C-11 or C-12 dry battery tube.

It is the properties of the special patented filament used in C-299 that make it so efficient. The outstanding feature of the filament is its extremely high electron emission at a low temperature. Fig. 117 shows the electron emission in milliamperes obtained at filament terminal potentials between 1 and 3 volts.

Within the limits of electron emission the plate current is proportional to both plate voltage and grid voltage. Fig. 98 illustrates the variation of plate current with plate potentials between zero and 80 volts, and at zero grid potential.

The most important static characteristic of a vacuum tube is the grid voltage control of plate current. In a well-designed amplifier tube this curve is practically a straight line at all negative grid potentials. The steepness of the curve roughly indicates the relative effect of grid voltage variation on plate current. Fig. 12A shows the values of plate current obtained at grid potentials between negative six and positive two volts, at two fixed values of plate potential.

C-299 is an extremely good detector tube when used either in a regenerative circuit or a straight circuit with radio-frequency amplification. The curve in Fig. 106 illustrates the amount of detector action or relative audibility obtained with filament terminal voltages between 2 and 4 volts. The curve is very steep between 2 and 3 volts, but is almost flat between 3 and 4 volts. This illustrates that practically nothing is gained in audibility by the use of an excessive filament voltage. On the other hand such use will greatly decrease the life of the tube.

Fig. 118 shows the detector action or relative audibility obtained with plate potentials from 20 to 70 volts, with the filament terminal potential fixed at 3 volts. Between these values audibility is almost directly proportional to the plate voltage. Very good audibility is obtained at 40 volts, and it is not recommended that this voltage be exceeded, in general practice, as doing so will cause excessive plate current and shorten the active life of the B battery.

As more fully explained on Page 158, of this book, mutual conductance is the factor that most accurately expresses the relative merit of a vacuum tube as an amplifier, oscillator or detector. The over-all efficiency of the vacuum tube is adequately expressed in the ratio of mutual conductance to power consumed by the cathode or filament. The mutual conductance of the tube varies with several factors. Variation with respect to plate voltage is illustrated in Fig. 120, with respect to grid voltage in Fig. 104.

Amplification constant and plate impedance are the two factors that determine the mutual conductance of the tube. Mutual conductance is directly proportional to the amplification constant and inversely proportional to the plate impedance. The amplification constant varies slightly and plate impedance varies widely with both plate and grid potential. Fig. 112 illustrates these variations with respect to plate voltage. Fig. 113 shows the variation of plate impedance with grid voltage between negative 6 and positive 2 volts at two fixed values of plate potential.

As more generally and fully explained on Page 157, of this book, the term "miles amplification" is used in expressing the gain obtained in a vacuum tube circuit. The gain in miles obtained in any circuit is within certain limits proportional to a number of factors. One of these is the potential applied to the plate of the tube. The curves in Figure 108 show the gain in miles obtained at plate potentials between 15 and 85 volts, at two fixed values of grid potential. These curves are a good illustration of the importance of using a negative grid potential in the amplifier circuit. The curve for zero grid potential shows that with a plate potential of 40 volts the gain is 20 miles. With a negative grid potential of $1\frac{1}{2}$ volts and the same plate potential the gain is 26 miles. Referring to the table, Fig. 142B, it will be seen that a 20-mile gain represents a current ratio of 8.83, and that a gain of 26 miles represents a ratio of 17. Thus under the conditions stated the use of a negative grid potential of $1\frac{1}{2}$ volts almost exactly doubles current ratio or audibility.

Another controlling factor of the gain in miles is the filament voltage. The curves in Fig. 102 show the gain in miles obtained with filament voltages between $1\frac{1}{2}$ and 3 volts. Two values of plate potential are used, 40 and 80 volts. For each of these potentials two curves are shown, one with the grid potential at zero, and the other with a grid potential of -1.5 volts. Note that greater gain is obtained with 40 volts on the plate and a negative grid potential of 1.5 volts, than when using 80 volts on the plate with zero grid potential.

The curves in Fig. 127 again illustrate the necessity of using a negative grid potential in an amplifier circuit in order to obtain the maximum gain. They also show that the amount of grid potential necessary is proportional to the plate potential used. When using 80 volts on the plate, and zero grid potential, the gain is approximately 23 miles. When using a negative grid potential of 3 volts, the gain is approximately 30 miles. Referring to the table, Fig. 142B, it will be seen that 23 miles gain represents a current ratio of 12.25, and that a 30-mile gain represents a current ratio of 26.3. This means that the use of the negative grid potential a little more than doubles the audibility.

Fig. 122 shows the comparative power outputs of the C-299 and C-301. These curves, which refer particularly to an amplifier circuit of the type commonly used, show that at an alternating grid potential of 3 volts, the output of the C-299 is 3.6 milliwatts, while the output of the C-301 is only 1.8 milliwatts. This clearly shows the superiority of this new Cunningham dry battery tube over the previous 5-volt 1-ampere storage battery tube.

CUNNINGHAM DETECTOR TUBE TYPE C-300

Cunningham detector tube type C-300 is a gas content tube of extreme detector sensitiveness and mounted on the standard navy base. Its design characteristics permit of critical adjustment of plate potential and filament voltage. When these factors are very carefully adjusted this tube is the most sensitive detector manufactured.

For accurate filament current control a rheostat having a low maximum resistance, between 2 and 4 ohms, should be used. This permits very fine adjustment of filament terminal voltage at the critical value, which is generally just below 5 volts.

Due to its gas content it operates at plate voltages between 18 and 25 permitting operation on a single 22½-volt B battery. Initial B battery and upkeep cost are, therefore, lower than with tubes requiring 40 to 100 volts.

Adjustment for maximum detector sensitiveness is quite critical and often changes in the plate potential as small as half a volt cause considerable change in audibility. It is, therefore, recommended that circuits designed for this type of tube be provided with a suitable means for making fine adjustment of plate voltage. The most satisfactory method of doing this is to use a potentiometer of 200 to 400 ohms resistance, connected directly across the 6-volt A battery. The contact

arm of this potentiometer should be connected to the negative terminal of the B battery, as illustrated in Fig. 97. A grid condenser and grid leak should always be used with this tube. Their values are not critical, but it is general practice to use a grid condenser having a capacity of .00025 mfd. and a grid leak having a resistance between 2 and 5 megohms. The proper location of these parts is illustrated in Fig. 97. C-300 can be used as a detector in any receiver equipped with standard audiofrequency amplifying transformers.

SPECIFICATIONS

Filament Terminal Voltage.....	5 V.
Filament Supply Voltage.....	6 V.
Filament Current	1.0 Amp.
Plate Voltage	18 to 25 V.
Plate Current	¼ to 1 Milliamps.
Output Impedance	10,000 ohms at 20 volts
Dimensions (over all).....	1¾ x 4 5/16 inches
Base	4 Prong Standard

CHARACTERISTICS OF OPERATION

Although the filament current of the C-300 detector tube is rated at 1 ampere, with a terminal potential of 5 volts, a 5 per cent. variation in either direction is allowable. Fig. 132 shows the variation of filament current with respect to filament voltage for a tube with a normal filament, and also for two tubes having current readings 5 per cent. above and 5 per cent. below their normal value.

The gas content detector tube, for maximum audibility, requires extremely critical adjustment of filament voltage as illustrated by the curve in Fig. 116 showing two maximum values of relative audibility, one, at a little less than 5 volts, and the other at 6 volts. The first one, which gives by far the greatest detector action or signal strength is the point at which the tube should be operated for obtaining best results. Under normal operation conditions practically all gas content detector tubes will develop a hissing noise at some particular filament temperature. This is commonly called "the hissing point" and the tube should always be operated just below it rather than above it. The audibility falls very low at the hissing point. This is illustrated in Fig. 116, where the hissing point occurs at about 5.3 volts.

The curve in Fig. 133 shows the necessity for critical adjustment of the plate voltage. In this case the maximum detector action is obtained at a plate potential of 20½ volts. This does not hold true for

all tubes but varies between 18 and 25 volts. The maximum audibility at $20\frac{1}{2}$ volts is approximately 70. If the plate voltage is reduced to 18 volts the audibility drops to 36. Again, if the plate voltage is increased to 22 volts the audibility drops to 40. This is an extremely good illustration of the necessity of using an "A" battery potentiometer or other means of making fine adjustment of plate voltage when using a gas content detector tube.

The amount of detector action obtained is to a large extent proportional to the effect of grid voltage in controlling plate current. The steepness of the curves in Fig. 126 which illustrates plate currents obtained with varying grid voltages at two fixed values of plate potential, indicates the extreme sensitiveness of this tube as a detector.

CUNNINGHAM AMPLIFIER MODEL C-301-A

C-301-A is a highly efficient storage battery tube designed for use both as an amplifier and detector. It replaces our previous amplifier tube, type C-301, and will operate efficiently in any circuit designed for that type of tube.

The great superiority of this tube is due to the new and patented filament. It is similar to the filament in our C-299 dry battery tube and draws only one-fourth of an ampere at a terminal potential of 5 volts. This is only one-fourth the power required for heating the filament of the C-301.

In addition to the tremendous saving in filament energy, this new tube has a higher amplification constant and a higher mutual conductance than the C-301, giving it a power output more than twice as great.

Unlike previous tubes, failure of the filament is seldom due to actual burn out unless excessive voltage is applied to the terminals. The end of the useful life of the tube is indicated by a decrease in the electron emission from the filament, or by the necessity of using an increased terminal potential in order to obtain satisfactory results.

If by accident excessive filament or plate voltage is applied to the tube it may lose its activity, and will function in a manner similar to a tube whose useful life is completely exhausted. In most cases the activity may be restored by lighting the filament at the rated voltage for a period of 20 to 30 minutes with the plate voltage entirely off.

The mechanical construction of the elements of this new tube is far more rugged than that of any previous type. The method of mounting

the elements has been improved along lines that insure constancy of location.

SPECIFICATIONS

Filament Terminal Voltage.....	5 V.
Filament Supply Voltage.....	6 V.
Filament Current25 Amp.
Plate Voltage	40 to 100 V.
Plate Current	1 to 6 Milliamps.
Amplification Constant	8
Mutual Conductance	475 micromhos at 40 volts plate and zero grid potential
Mutual Conductance	710 micromhos at 100 volts plate and 4 volts negative grid po- tentai
Dimensions (over all).....	1¾ in. x 4 5/16 in.
Base	4 Prong Standard

This new tube, due to its high mutual conductance, is an extremely good amplifier in both radio-frequency and audio-frequency circuits. When used as an audio-frequency amplifier the grid should always be kept at a negative potential with respect to the filament, in order to obtain maximum gain, maximum B battery life, and a minimum of distortion. The grid potential for best results depends upon the plate voltage, and should be approximately of the value given in the following table:—

<i>Plate Potential</i>	<i>Necessary Grid Potential</i>
40 Volts.....	0.5—1.0 Volts Neg.
60 Volts.....	1.0—3.0 Volts Neg.
80 Volts.....	3.0—4.5 Volts Neg.
100 Volts.....	4.5—6.0 Volts Neg.

For this purpose extremely small dry cells, such as are commonly used in the small type of flashlight, should be satisfactory, although the use of the larger type of flashlight battery will be more economical. The proper method of connecting such a battery into the circuit is illustrated in Fig. 96.

C-301-A is also a very good detector. Although not quite as sensitive as a critically adjusted C-300, it is in some cases more desirable due to its low filament current. It is particularly efficient as a detector when

used in circuits employing radio-frequency amplification. For detector use the grid return connection should be made to the positive filament terminal as illustrated in Fig. 97. Critical adjustments of the grid leak and grid condenser are not required, but it is recommended that a condenser of .00025 mfd. and a grid leak of from 2 to 5 megohms be used. These are the approximate values of grid condenser and grid leak now used in the detector circuits of standard receiving sets and therefore no change of these parts is necessary. Although the plate voltage for detector action is not critical, it is recommended that approximately 40 volts be used.

The extremely high vacuum used in C-301-A makes it very quiet in operation. Receiving sets that give good results and operate quietly when first installed often develop noises, similar to those caused by static, after they have been in use for some time. Unfortunately many owners of receiving sets immediately jump to the conclusion that these noises are due to a defect in one or more of the vacuum tubes in the set. This is seldom if ever the case, and the cause of the noise can generally be traced to a discharged B battery, a loose or corroded connection somewhere in the wiring or a poor contact in the filament rheostat.

It is generally hard to distinguish such noises from those caused by static. When operating a set if static is apparently very bad it is recommended that the antenna system be entirely disconnected from the set. If any part of the noise continues it is being developed within the set itself and should be traced and eliminated before further operation is attempted.

CHARACTERISTICS OF OPERATION

The AC characteristics of a vacuum tube illustrate its performance under actual operating conditions. The curves in Fig. 110 show the comparative effect of equal effective AC grid voltages on the effective AC plate currents of the C-301 and C-301-A. These curves are determined by the mutual conductance of the respective tubes and illustrate the superiority of the new C-301-A over the previous type C-301 not alone as an amplifier but also as a detector and oscillator.

The curves in Fig. 119 show comparative power outputs of the C-301-A and the C-301. They were made from tests with a standard amplifier circuit at a frequency of 2,000 cycles, which is a fair average of the frequency encountered in broadcast reception, and illustrates the comparative merits of these tubes under actual operating conditions.

As previously stated when using the C-301-A as a detector, satisfactory operation can often be obtained with a filament potential as low

as 4 volts. This act is well illustrated in Fig. 130, which shows the detector action (as determined by the relative audibility of signals) obtained with filament voltages between $2\frac{1}{2}$ and 5 volts. Note that in this curve, which was plotted from the averages of readings taken with five C-301-A tubes, maximum audibility is obtained at about 3.75 volts. It should always be remembered that the use of the lowest possible filament voltage will tend to prolong the active life of the filament. It is not necessary to use a separate source of filament supply for this purpose, as the terminal voltage can be sufficiently reduced with a suitable rheostat.

This type of tube, as well as the C-299, becomes highly discolored in the process of evacuation. This discoloration has absolutely no effect on the operating characteristics of the tube. It does not indicate the type of cathode or filament material used and is in no way an indication of the tube's merit.

The operation of the tube is not critical, with respect to filament current. Operating the filament at the lowest possible temperature at which good results may be obtained will naturally increase the life of the tube. When used as a detector satisfactory results are often obtained with a filament terminal potential as low as 4 volts. When using a 6-volt battery as a source of filament current supply, the rheostat should have a resistance of at least 4 ohms, and the use of rheostats with resistances up to 10 ohms will be found useful, particularly when the tube is used as a detector. For all ordinary purposes rheostats designed for the C-300 or C-301 will be satisfactory for use with the C-301-A.

When using a filament terminal potential of 5 volts, detector action or audibility is almost directly proportional to plate voltage, as indicated in Fig. 114. However, it is not recommended that more than $4\frac{1}{2}$ to 50 volts be used for this purpose, due to the fact that the necessary lack of negative grid potential in a detector circuit will cause excessive plate current, thereby reducing the active life of the B battery.

The direct plate current of a vacuum tube, is, within the limits of the electron emission of the filament, proportional to both plate current and grid voltage. Fig. 111 shows the plate current in milliamperes at plate potentials between zero and 140 volts and with zero grid potential. Fig. 109 shows variations of plate current obtained with grid potentials between negative 10 and positive 6 volts, at two fixed values of plate potential. These two curves will permit the user to calculate the plate current in a vacuum tube circuit under any normal operating condition.

The mutual conductance of a vacuum tube is a very important factor, being indicative of the ability of the grid potential to control plate current. The mutual conductance of the C-301-A is higher under any given condition than that of any other tube on the amateur market. Mutual conductance varies with both plate voltage and grid voltage. Fig. 129 illustrates this variation with respect to plate voltage. Fig. 101 illustrates the values of mutual conductance obtained with grid potentials between negative 10 and positive 2 volts, at plate potentials of 40 and 100 volts. Although the two curves in this figure show that the mutual conductance is higher at zero grid potential than when using a negative grid potential, they must not be taken to mean that the tubes should operate at zero grid voltage as doing so would introduce distortion.

Amplification constant and plate impedance are the two factors from which the mutual conductance of a vacuum tube is calculated. The amplification constant varies slightly and the plate impedance widely with both plate voltage and grid voltage. For convenience the curves of these two factors are plotted on the same graph. Fig. 103 shows their variation with respect to a varying plate potential between 20 and 100 volts.

Although the amplification constant remains practically constant plate impedance is directly proportional to the value of the negative grid potential. Fig. 100 illustrates these features with two fixed values of plate voltage. Note that there is little difference in the amplification constant, even between the two values of plate voltage.

As more fully explained on Page 157 of this book, the term "miles amplification" is used to express the gain obtained in any vacuum tube circuit. The gain in miles is proportional to a number of factors, one of which is plate voltage. The curve in Fig. 123 is illustrative of this feature.

Fig. 105 shows the miles amplification obtained with filament voltages varying between $2\frac{1}{2}$ and 5 volts, at two fixed values of plate potentials. These curves again illustrate the value of using a high plate voltage in an amplifier circuit in order to obtain the highest possible audibility. Note that the maximum gain shown here with a plate potential of 40 volts is $26\frac{1}{2}$ miles, while the maximum gain with a plate potential of 100 volts is 30 miles. Referring to the table, Fig. 142B, it will be seen that these two values of gain expressed in miles amplification represent current ratios of approximately 18 and 26.3 respectively. This means that the use of the higher plate potential will give an increased audibility of over 45%.

The curves in Fig. 115 illustrate the gain obtained in miles amplification at two fixed values of plate voltage with a grid potential varying between negative 5 and positive 2 volts. These curves are both illustrative of the necessity of using a negative grid potential in an amplifier circuit. For instance, if the rheostat is placed in the positive filament lead and the grid return from the secondary of the amplifying transformer is made between this rheostat and the battery, the grid will have a positive potential in the neighborhood of 1 or 2 volts. Note the greatly reduced gain under such conditions and always be sure that your A battery leads are not reversed.

The three curves shown in Fig. 125 are plotted from the results of tests made with an amplifier of design similar to that generally used in broadcast reception. They show voltage across the load, the current through the load, and the power in the load at grid potentials between zero and 8 volts.

EXTRA NOTES ON C-7 MODEL

1. The latest UV-201-A and C-301-A tubes oscillate more freely than the original types. In the C-7 model this may cause the intermediate frequency amplifier to oscillate beyond control. This is true when the Heterodyne dial is rotated (with volume condenser fully retarded), and a series of "whistles" or beat notes are heard. To eliminate this difficulty run the grid returns of the two R. F. Transformers (Terminals S-1 and S-1) direct to Negative 6 volt lead and not to the bias battery.

2. Likewise in the audio amplifier, it may be found contrary to general opinion, that better quality and volume may be obtained without the audio C bias, unless 120 volts are used on the amplifier.

3. To obtain sharp tuning on the lower wavelength range, a series antenna of .00025 MF should be connected between the antenna and the post on the antenna inductance. A small switch should be provided to short circuit this condenser when receiving the longer wavelengths.

CHAPTER III

ADAPTERS AND ATTACHMENTS

To use the Model C Super-Heterodyne with an antenna, provision must be made to tune the antenna to the desired signal and to transfer this energy to the input of the Super-Heterodyne which must also be tuned. An ordinary variocoupler will do this, but only for certain wavelengths depending upon the specifications of the variocoupler, and even then with a doubtful degree of selectivity.

A special Antenna Adapter known as the model K has been designed for this purpose, and is illustrated in Figs. 143 and 144. The schematic wiring diagram is shown in Fig. 145.

The antenna tuning circuit of this device consists of an inductance variable by taps through a switch, and a variable condenser designated as the Antenna Condenser. Through the use of certain portions of the inductance and certain adjustments of the variable condenser the antenna can be tuned from wavelengths of from 160 to 850 meters. This holds true on the average antenna consisting of a single wire 80 to 170 feet long, total, and about 30 to 60 feet high. The amount of inductance and condenser to use for a given wavelength will depend upon the individual antenna and can only be found accurately by experiment. Suppose that the antenna circuit is tuned to 400 meters the wavelength of Havana, this energy will then be transferred to the Secondary inductance L-2 if L-2 is also tuned to 400 meters by adjusting the wavelength dial on the C Model.

It will be seen from Fig. 145 that the inductance L-2 and L-3 have taken taken place of the loop. However, these inductances are too small in diameter to pick up any great amount of signal energy directly, but will pick up energy from a tuned antenna circuit. A wavechange switch is provided to short circuit L-3 when operating on the shorter wavelengths.

From the graph in Fig. 23 it will be noted that with L-2 used alone, the wavelength condenser covers a wavelength range of 160 to 500 meters (antenna adapter wavechange switch on S). When the wavechange switch is on L, placing both L-2 and L-3 in series, the wavelength dial then tunes from wavelengths of 400 meters to 850 meters. Some of the wavelengths, those from 400 to 500 meters, can be received on either the S or L position and this is called the overlap, in this case about 20 per cent. Greatest signal strength is obtained

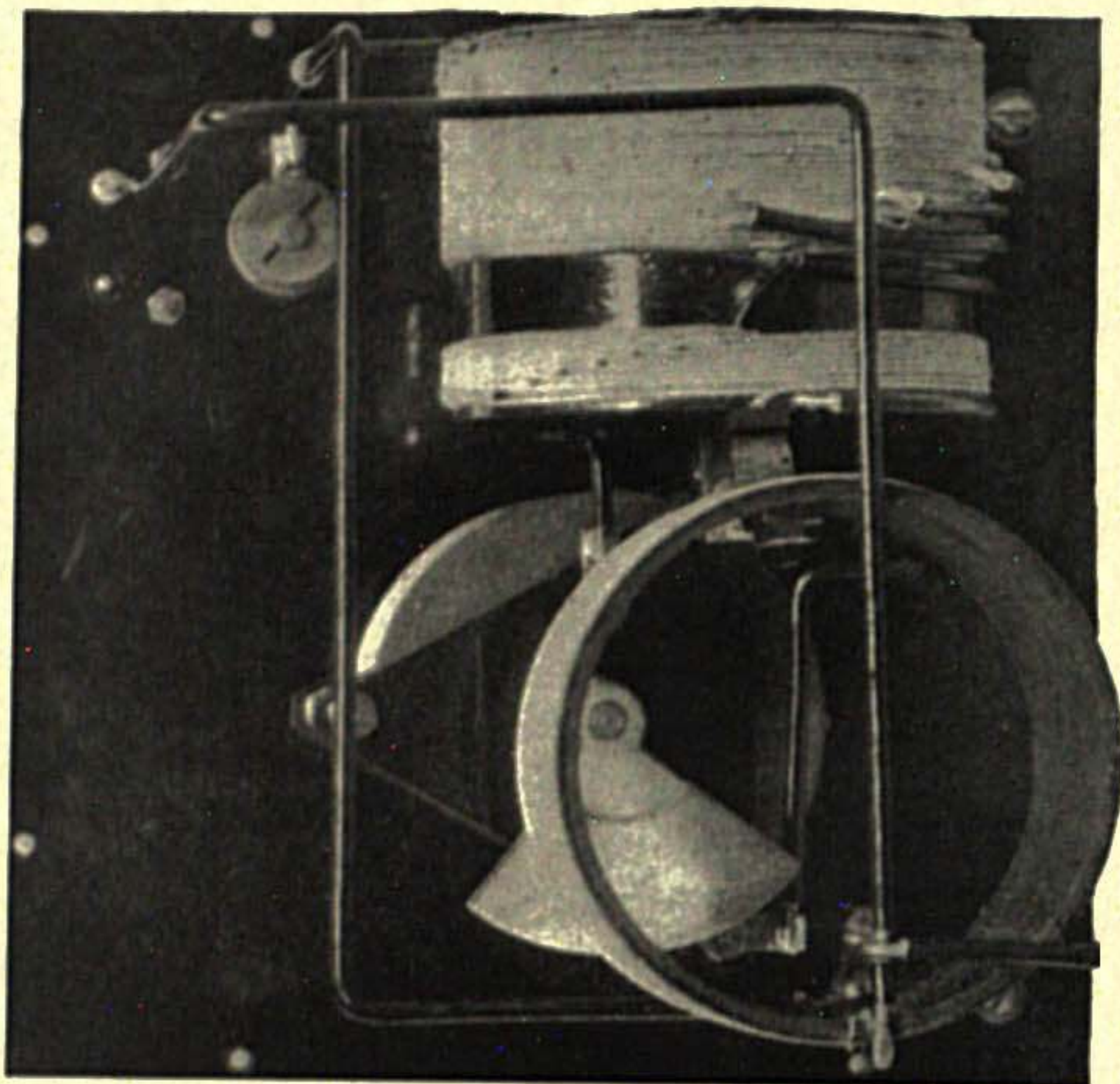

Fig. 144
Rear View Model "K" Antenna Adapter.

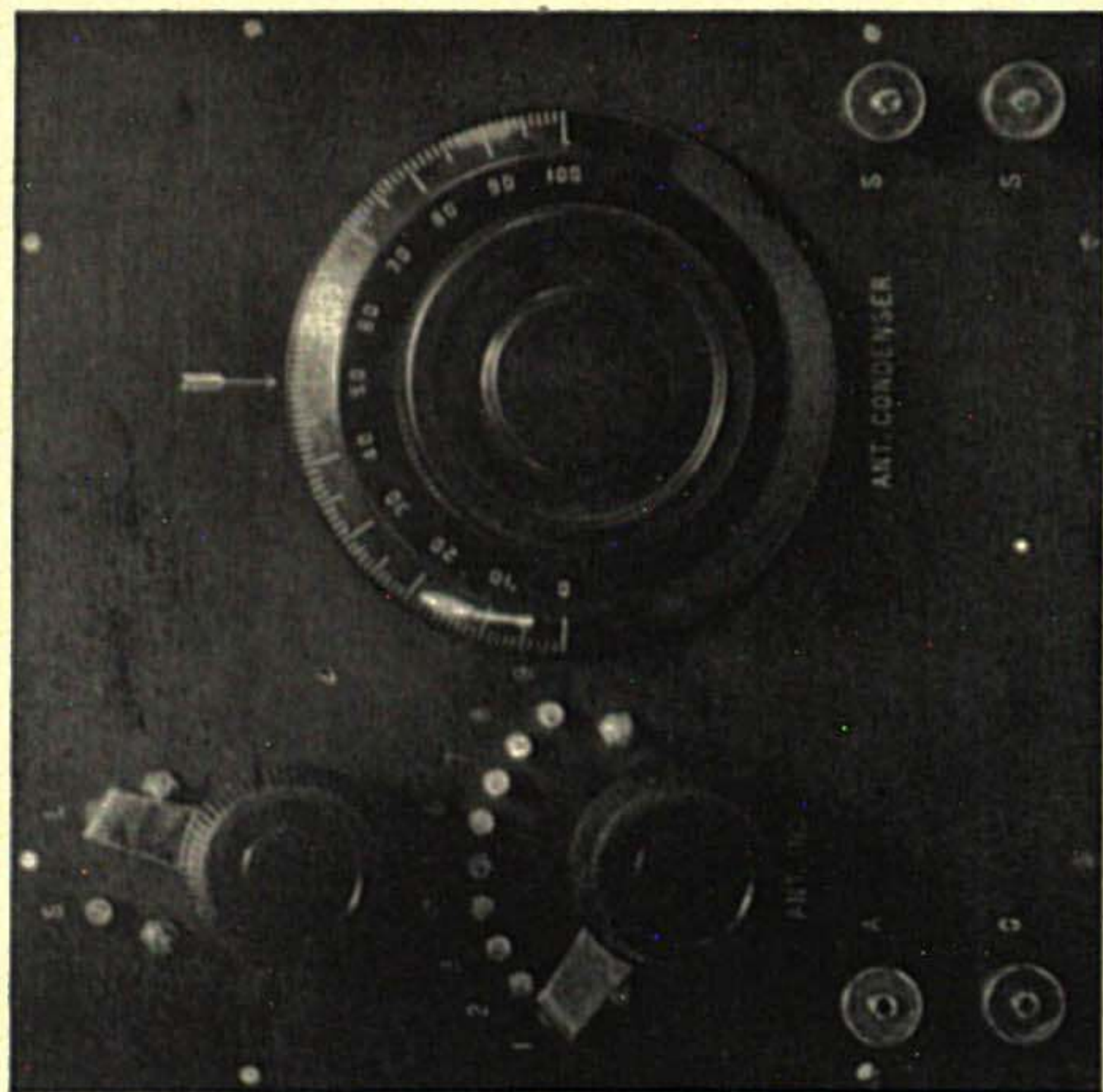

Fig. 143
Front View Model "K" Antenna Adapter. Size 8" x 8" x 8"

in the Antenna Circuit when using maximum condenser and minimum inductance, but this gives the least degree of selectivity. Greatest selectivity is obtained when using a maximum of inductance and the smallest amount of antenna condenser, but this gives a considerably weaker signal. A combination of the two can be used for the desired result. In the secondary circuit, if there is an opportunity for choice, best results are obtained by using maximum inductance and a minimum of condenser. For example, when tuning to 500 meters a stronger signal would be obtained by having the wavechange switch on L and working the wavelength dial at the lower portion of the scale.

When operating this adapter in connection with the C Model it must be remembered that the Heterodyne adjustments for any particular wavelength will be same as for loop operation. To tune to, say, Detroit's wavelength, 517 meters, set Heterodyne wavechange switch on L and also adapter wavechange switch on L. Consult graph Fig. 24 for approximate setting for 517 meters and see graph Fig. 23 for setting of Wavelength dial for the same wavelength. With these two dials set, then regulate Antenna Inductance and antenna condenser until maximum static is heard, which will indicate that antenna circuit is being brought into resonance with the secondary circuit. Re-regulating the Heterodyne dial will bring in the station and then the signal can be cleared up by re-regulating the Antenna Condenser and Wavelength dial. Similar operations are made for stations having different wavelengths.

The experimenters that build this unit should bear certain things in mind. Do not use any commercial soldering flux such as muriatic acid, Nokorode, etc. Use only a solution of alcohol and rosin as previously explained. Test the coils and circuits for continuity and also test for grounds to be sure that none of the windings touch or make contact with the holding bracket. The coil L-1 should be insulated from the supporting bracket by a small piece of tape to prevent the anchor wires from touching the bracket (part No. 4).

With the antenna and ground disconnected from this unit, the coils within the cabinet can be used as a small loop and the real sensitiveness of this set is then demonstrated. Thirty miles from New York the New York stations can be received on these small coils with sufficient audibility to operate a 10 D Loud Speaker with plenty volume. Philadelphia stations WFI and WDAR are received with sufficient audibility to operate a loud speaker, this distance being 90 miles and during daylight. At night Schenectady, 165 miles distance, and KDKA, 400 miles distance, can be heard quite audibly but not quite

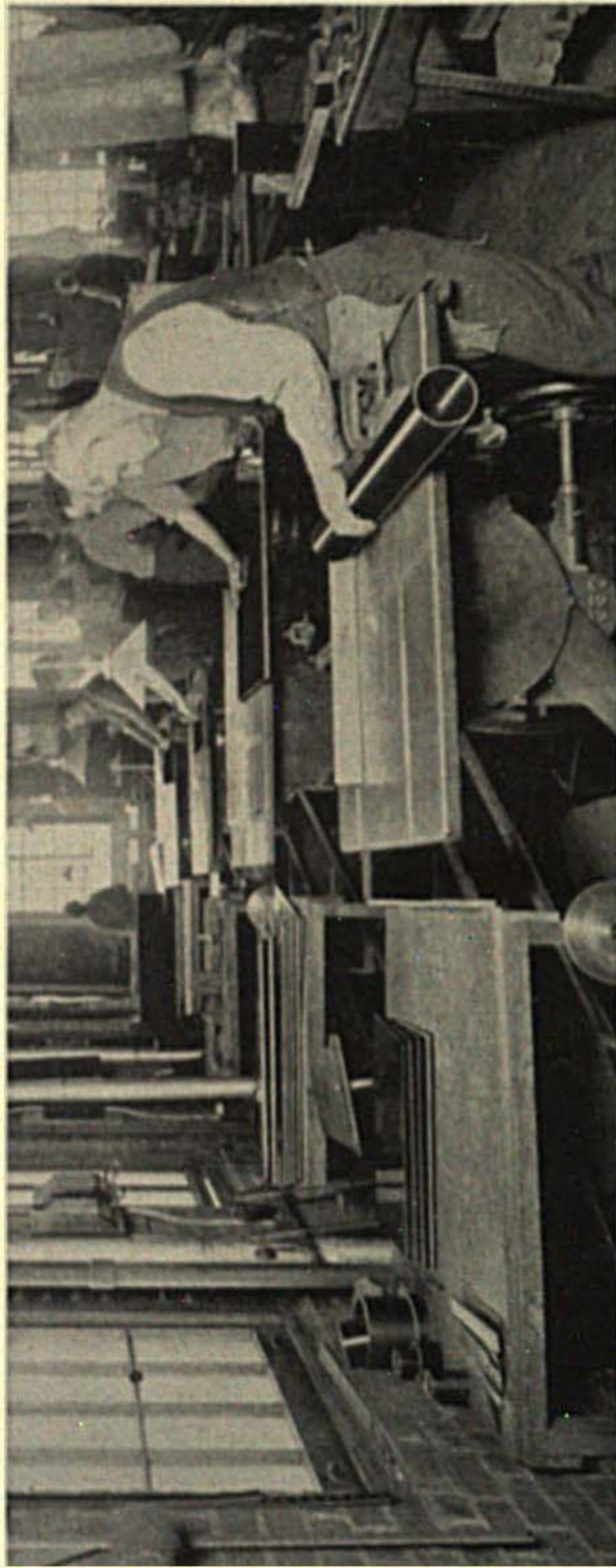

Manufacturing Formica.
Saws Trimming up the Finished Formica Sheet and Tubing.

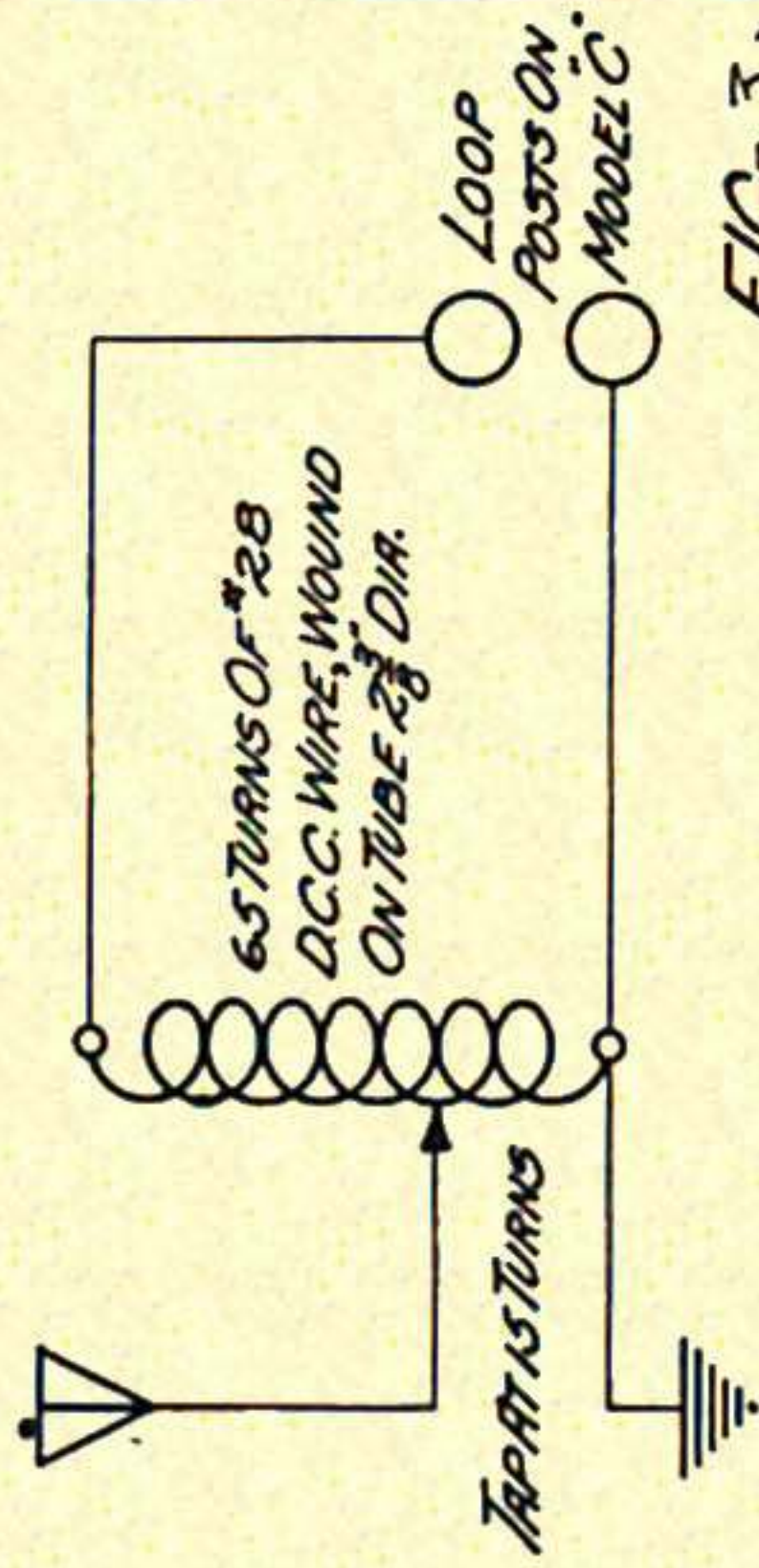

FIG. 3a

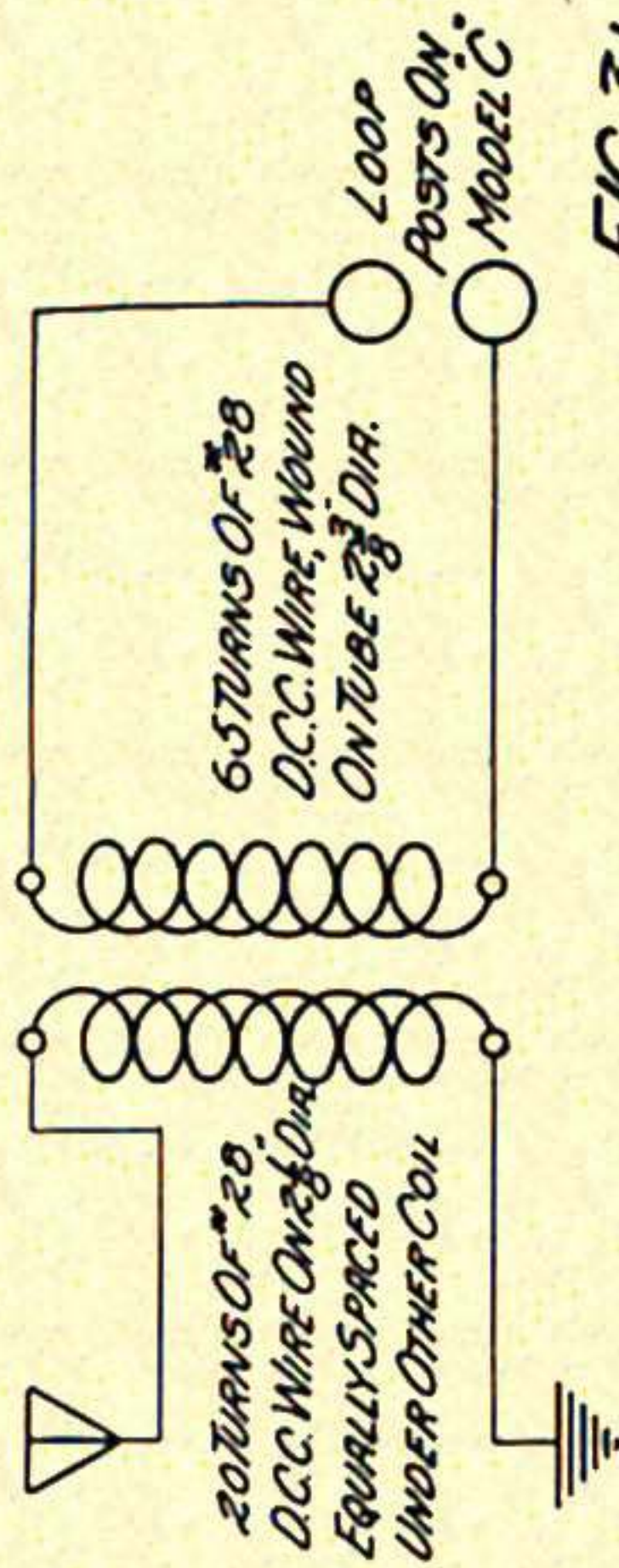

FIG. 3b

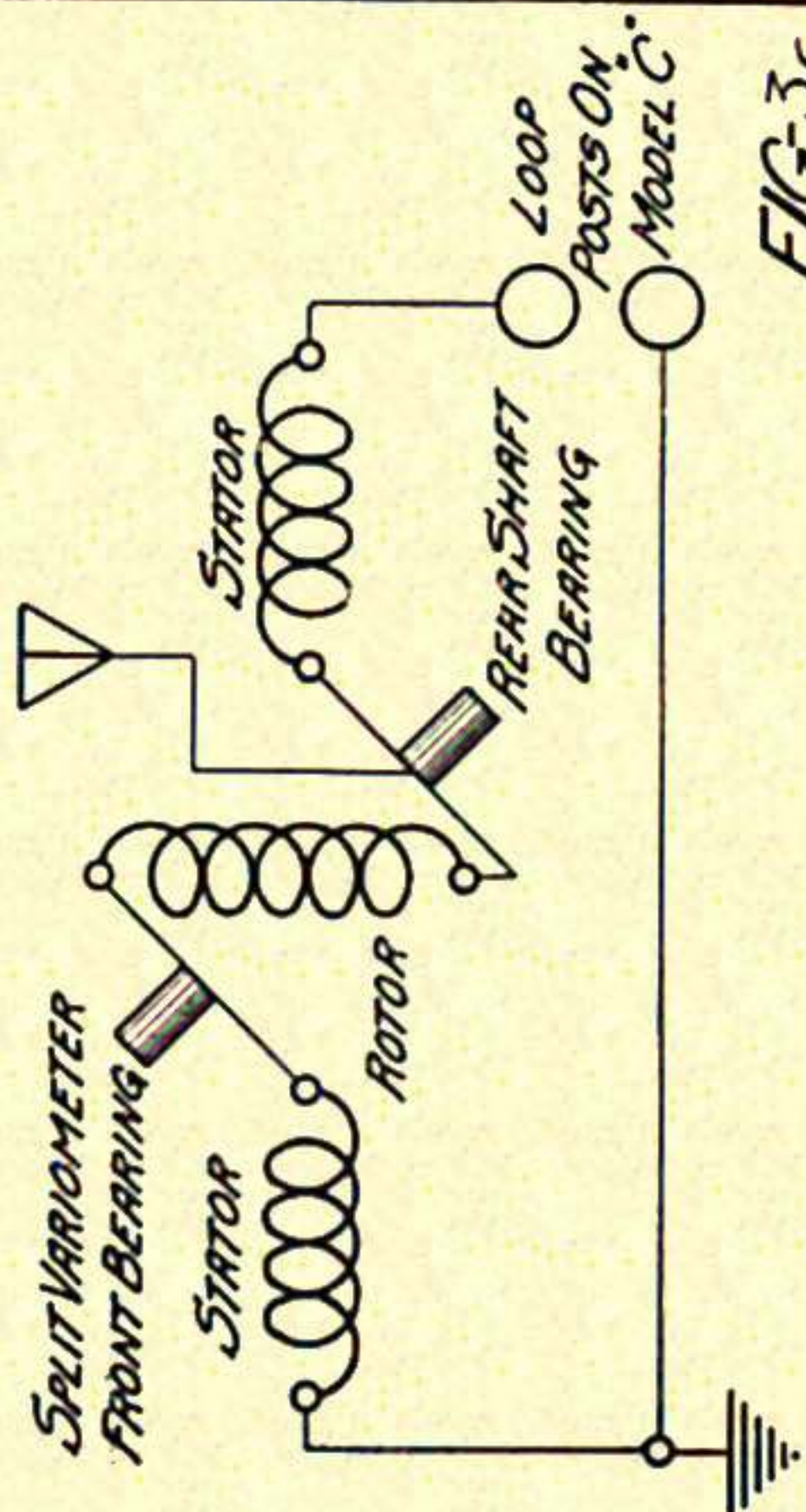

FIG. 3c

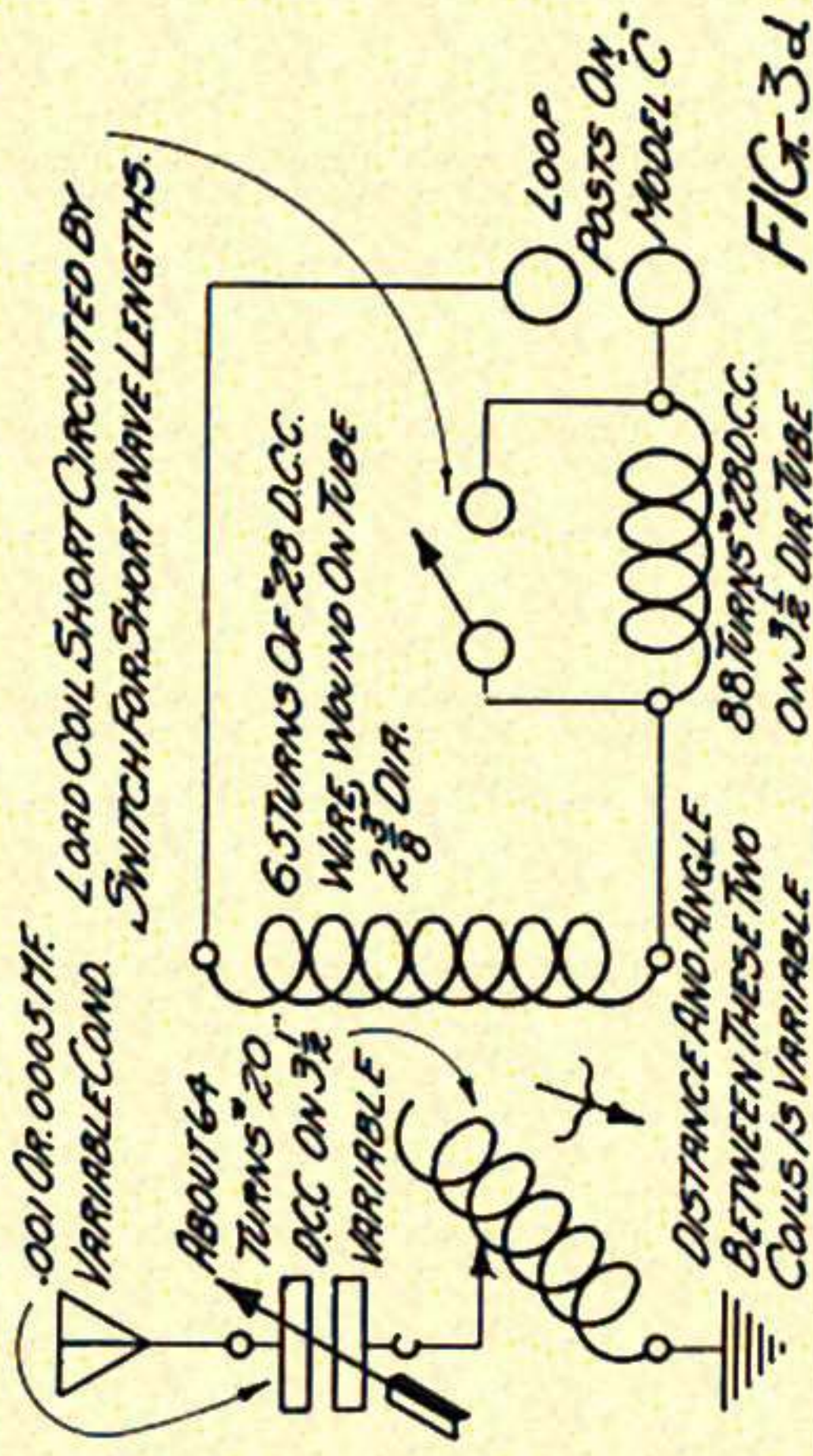

FIG. 3d

SHOWING FOUR METHODS OF SUBSTITUTING ANTENNA TUNING DEVICES IN PLACE OF A LOOP FOR MODEL C - SUPER HETERODYNE. WHILE THE FIRST THREE METHODS SHOWN ARE GOOD COLLECTORS, THE DEGREE OF SELECTIVITY OBTAINABLE IS NOT VERY HIGH. THE FOURTH METHOD SHOWN IS MOST DESIRABLE AS THE UNDESIRABLE INFLUENCES OF A POOR ANTENNA CAN BE ISOLATED FROM THE SECONDARY CIRCUIT AND THE BEST POSSIBLE COMBINATION OBTAINED BY CAREFUL MANIPULATION.

Fig. 147

ANTENNA ADAPTER, MODEL "K"

Do Not Depart From These Specifications by Substituting

LIST OF MATERIAL REQUIRED

Part No.	Name	Quantity	SPECIFICATIONS	Price
1	Cabinet	1	African Mahogany 8"x8"x7 $\frac{3}{4}$ " Deep, Open Front Std. Finish.....	\$5.85
2	Panel	1	Grade M Black Formica 8"x8"x $\frac{1}{4}$ " Plain.....	2.45
3	Variable Condenser	1	Gen. Radio Type 247 .001 MF. with Special Long Shaft.....	4.00
4	Primary Inductance	1	Special as per Specifications, with Bracket (L-1).....	2.60
5	Secondary Inductance	1	Special as per Specifications, with Bracket (L-2).....	1.25
6	Sec. Load Inductance	1	Special as per Specifications, with Bracket (L-3).....	2.25
7	Ant. Ind. Switch	1	Gen. Radio Type 139A with 9-138D Contacts 2,138Q Stops.....	1.41
8	Wave Change Switch	1	Gen. Radio Type 139A with 2-138D Contacts 2-138Q Stops.....	1.13
9	Binding Posts	4	Gen. Radio Type 138X.....	.60
10	Dial and Knob	1	4" Dial with 2 $\frac{1}{2}$ " Moulded Bakelite Knob.....	1.50
11	Wire	6 ft.	No. 12 Soft Drawn Copper Tinned, B. & S. Gauge.....	.12
12	Empire Tubing	6 ft.	No. 12 Black Impregnated.....	.66
13	Screws		Miscellaneous16
				<hr/>
				\$23.98
EXTRAS				
14	Drilling Panel		As per Specifications	\$.75
15	Graining and Engraving Panel		As per Specifications	5.40
				<hr/>
				\$6.15

loud enough to operate a loud speaker. The combination in the hands of an experienced operator will receive WDAP, WJAZ and KYW Chicago station, about 900 miles distance, without an antenna and ground; and with a good, audible signal.

The best antenna recommended for this unit would consist of a single wire 100 to 150 feet long, 30 to 60 feet high.

To further increase the range of the Model C Receiver, or to increase the volume from stations within its range, it is possible to add one stage of tuned radio frequency amplification before the signal enters the antenna unit. The unit designed for this purpose is shown complete in Figs. 148 and 149 and the schematic wiring diagram is shown in Fig. 150.

It will be noted from the wiring diagram that the antenna circuit is tuned to the incoming signal frequency in the usual manner and this voltage applied to the amplifier tube grid. The grid circuit of the C Model detector circuit is tuned to the same frequency. With both these grid circuits tuned to the incoming signal frequency there is an amplifying action present in the Model S unit tube, amounting to an amplification about 6 to 7 times or equal to about $\frac{1}{2}$ stage of audio frequency amplification. However, through the use of the potentiometer this amplifying action can be made regenerative and this amount of amplification considerably increased.

When using this unit, it is necessary to short circuit the antenna series condenser in the Model K antenna unit, otherwise the plate circuit of the S amplifying tube would be open. When using these units together, the plate circuit of the amplifier tube is tuned by varying the antenna inductance taps in the K model only.

A loop may be used by plugging it in the jack provided and in this case an external variable condenser must be added to tune the loop circuit. A variable condenser of .0005 M.F. maximum with shaped plates is suggested.

The successful operation of this S Model is quite complicated and difficult and only recommended to one skilled in careful tuning. It is possible, however, to master these tuning operations by practicing on a local station and later trying for results on a distance station. In the hands of a skilled operator it is possible to greatly strengthen the signals received from a distance station.

For the general layman, the two stage tuned radio frequency amplifier and antenna unit combined is recommended as a better combination than the S and K together. This unit is described further on.

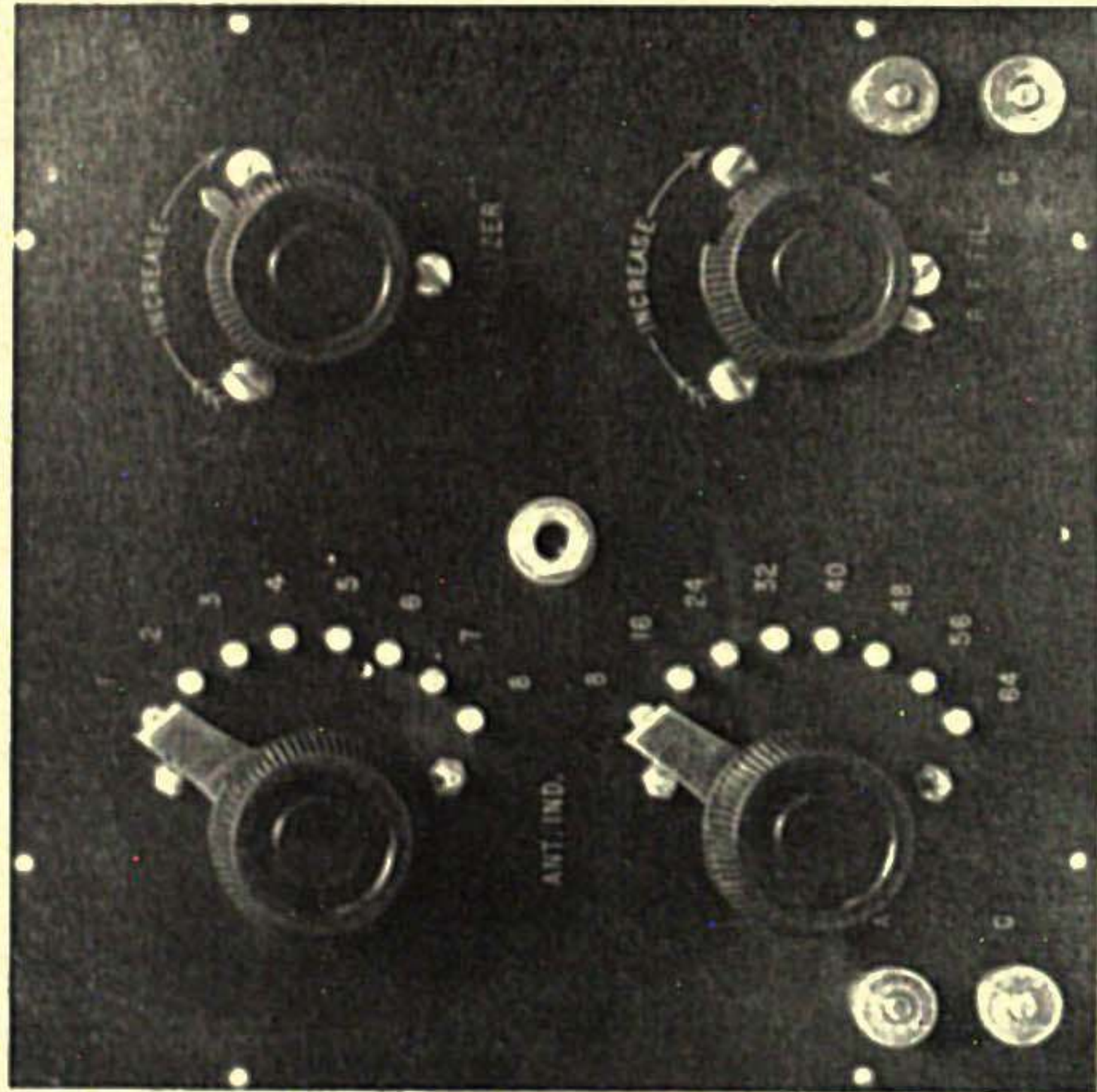

Fig. 148

Front View Model S 1-Stage Tuned Regenerative Amplifier

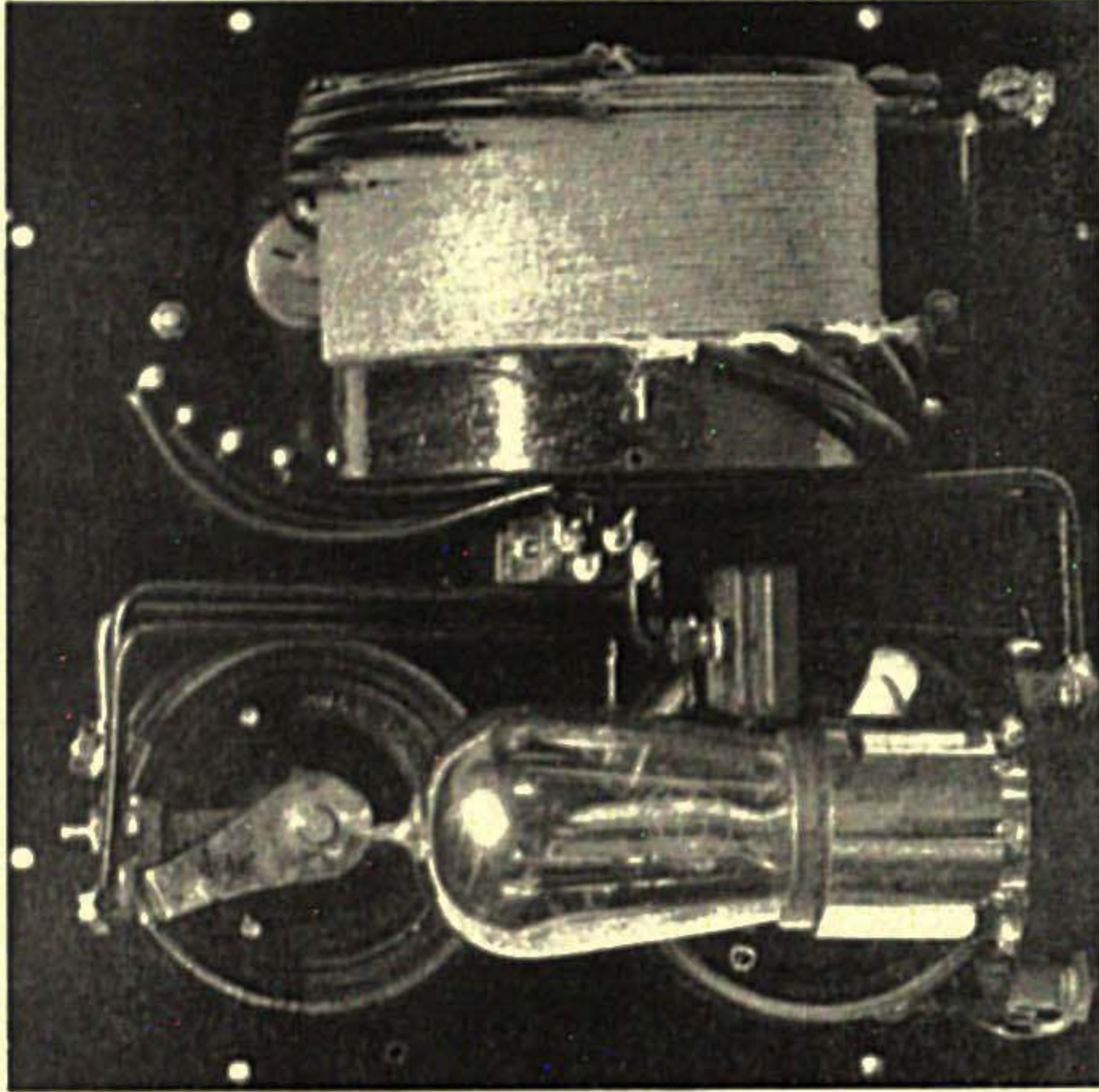

Fig. 149

Rear View Model S 1-Stage Tuned Regenerative Amplifier.

TUNED RADIO FREQUENCY AMPLIFIER, MODEL "S"

Do Not Depart From These Specifications by Substituting

LIST OF MATERIAL REQUIRED

Part No.	Name	Quantity	SPECIFICATIONS	Price
1	Cabinet	1	African Mahogany 8"x8"x7 ³ / ₄ " Deep, Open Front, Standard Finish.....	\$5.85
2	Panel	1	Grade M Black Formica 8"x8"x ¹ / ₄ "	2.45
3	Ant. Inductance	1	As per Blue Print Specifications, Complete with Bracket.....	2.90
4	Ind. Switches	2	Gen. Radio Type 139A with 16 Contacts 138D, 4 Stops 138Q.....	2.74
5	Rheostat	1	Gen. Radio Type 214A, 20 Ohm.....	2.25
6	Potentiometer	1	Gen. Radio Type 214 A, 400 Ohm.....	3.00
7	Socket	1	Gen. Radio Type 156	1.25
8	Bracket	1	For Socket as per Blue Print Specifications.....	.35
9	Jack	1	Closed Two Circuit Premier No. 131.....	.95
10	Condenser	1	.005 MF. Dubilier Typ: 600.....	1.00
11	Binding Posts	4	Gen. Radio Type 138X.....	.60
12	Screws		6 Rheostat Oval Hd., 2 Socket Rd. Hd., 4 Panel Screws, Rd. Hd. N. P. Bracket Screw28
13	Wire	12 ft.	No. 12 B. & S. Soft Drawn Copper, Round, Tinned.....	.24
14	Tubing	12 ft.	Empire Cloth, Tubing, Impregnated No. 12 Black.....	1.32
15	Wire	4 ¹ / ₂ ft.	No. 14 Flexible Lamp Cord.....	.45
				<u>\$25.63</u>
EXTRAS				
16	Labor		Drilling Panel as per Blue Print Specifications.....	\$.75
17	Labor		Graining and Engraving Panel.....	4.50
				<u>\$5.25</u>

A new instrument has been recently perfected for use with the Model C Super-Heterodyne, consisting of a 2 stage Tuned Regenerative Radio Frequency Amplifier and Antenna Adapter Combined.

With this instrument in front of a Model C Super-Heterodyne, one has practically all the amplification that is possible to utilize in a practical manner. The front and rear views of the finished instrument are shown in Figs. 151 and 152 and the schematic wiring diagram is shown in Fig. 156.

The function of this instrument is to pick up and amplify at radio frequency the very weak signals and then to transfer this energy to the Super-Heterodyne where it is further amplified at radio and audio frequencies.

A study of the wiring, Fig. 156, will simplify an explanation of its operation.

V-1 and V-2 are Radiotrons UV201A, the plate and filament voltages supplied from the same batteries as used for the Super-Heterodyne. A Master rheostat is provided to control the filament temperature of both tubes simultaneously. A potentiometer Stabilizer is provided for the second tube grid to enable its potential to be varied with respect to filament which gives the regenerative amplifying action at this point.

T-1, T-2 and T-3 are special transformers, the primaries and secondaries of which are quite loosely coupled. The ratio of the turns is quite high. The secondary of each transformer has a certain amount of inductance so that the variable condensers in parallel to these secondaries tune to wavelengths from 160 to 550 meters. In the first transformer T-1, the primary winding is so closely coupled to the secondary, that the secondary tuning also tunes the antenna circuit and it is not necessary to tune the antenna circuit individually.

Condenser C-2 marked Wavelengths tunes the 1st stage transformer T-1, Condenser C-2 tunes the 2nd stage transformer T-2 and the Wavelength Condenser in the C Model tunes the transformer T-3. For Wavelengths higher than 550 meters the Wavechange switch is placed in the Long position; this connects a small fixed condenser in parallel to each of the three condensers and the wavelength range of each of the three dials is then 300 to 750 meters.

The simplest system of connecting a Model S Amplifier to a Model C or any other loop receiver is to use a type C7 Antenna Adapter as the Radio Frequency Transformer. Secondary terminals 1 and 3 of the Transformer are connected in place of the loop used for the receiver.

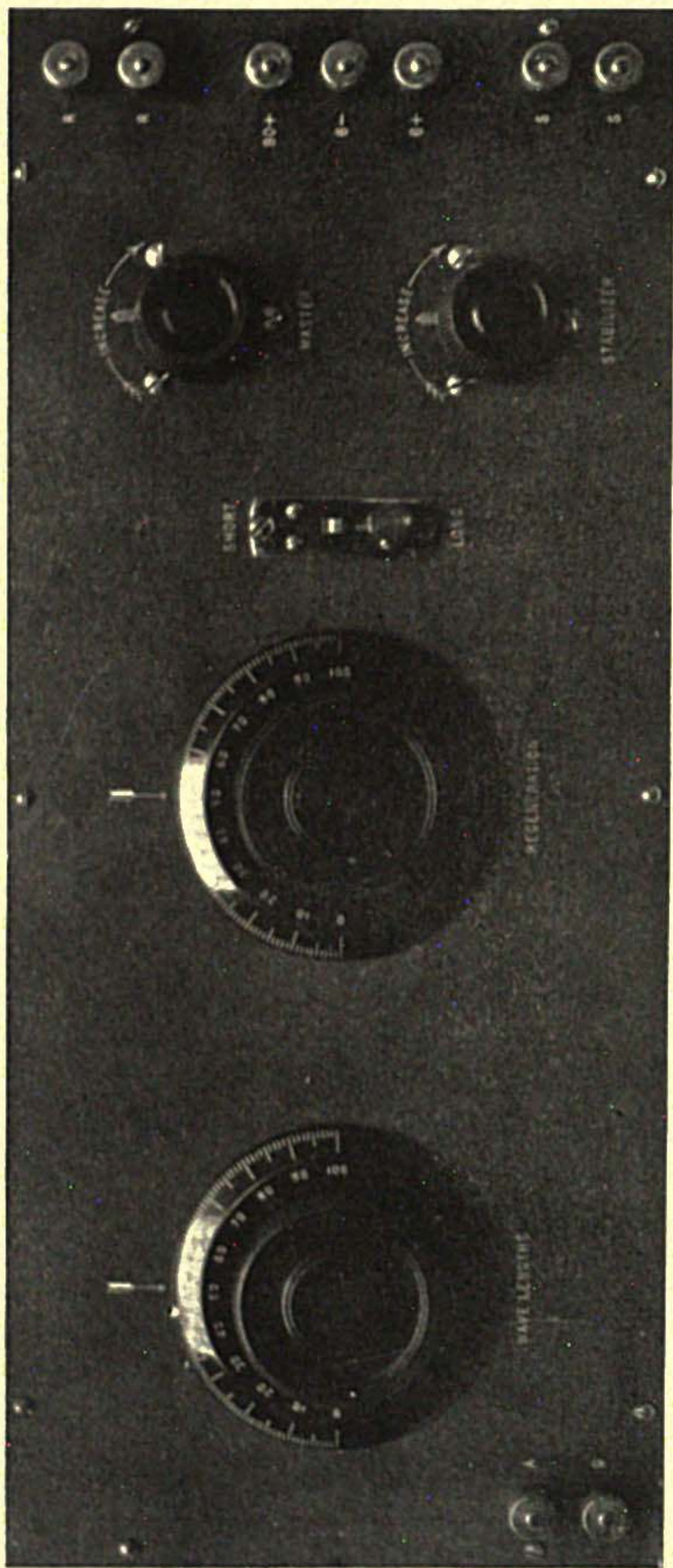

Fig. 151
2-Stage Tuned Regenerative Radio Frequency Amplifier Model "J" Front View.

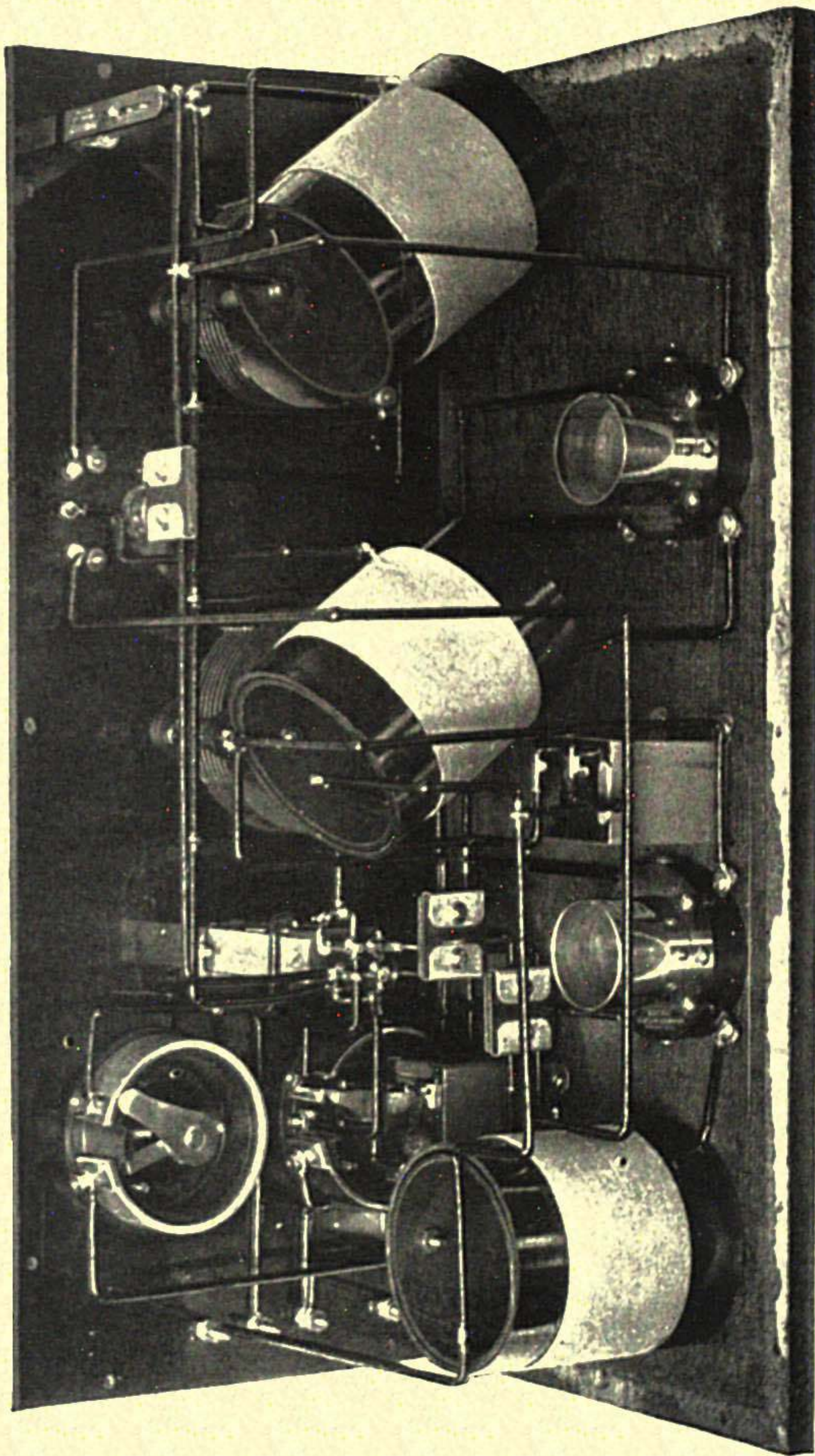

Fig. 152
2-Stage Tuned Regenerative Radio Frequency Amplifier Model "J" Rear View.

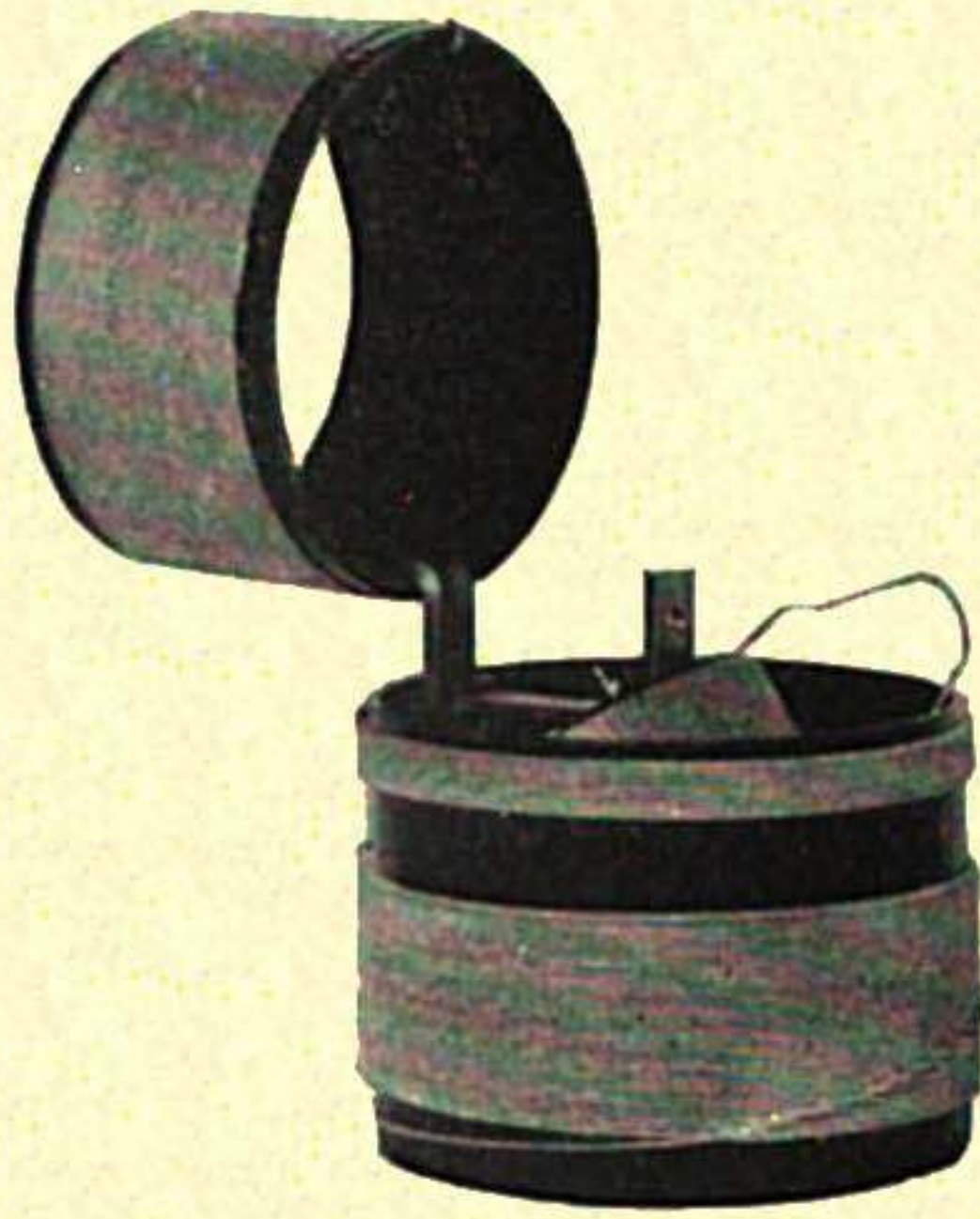

Fig. 154
Type "K" Adapter Inductances

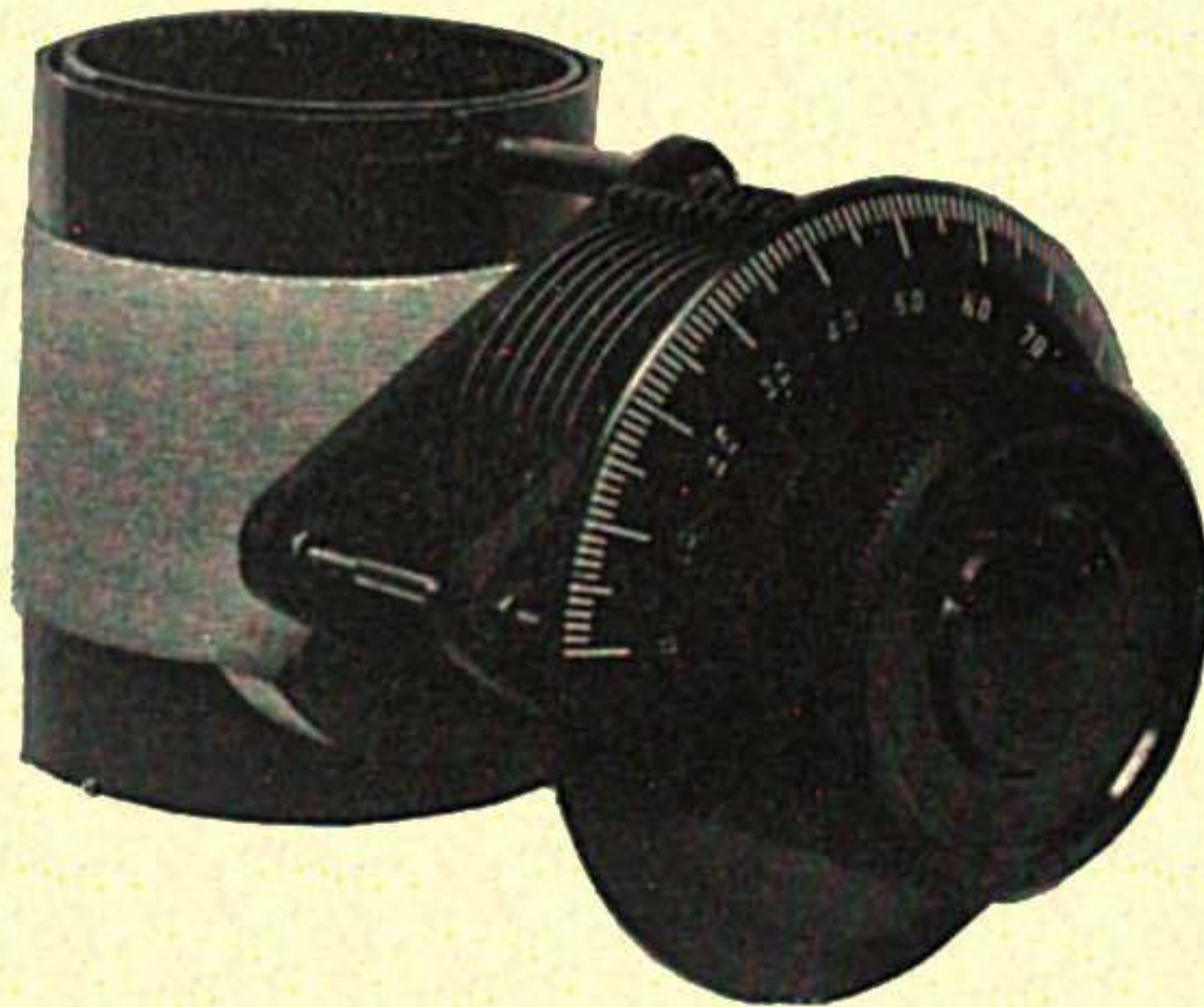

Fig. 155
Type "J" Transformer and Condenser

Posts S and S on the S unit are connected to Posts L and G on the Transformer. The Model S can be adapted to the C7 without the additional Antenna Inductance as it is already located in the C7 Receiver. In this case the Terminals S and S on the S unit are connected to posts L and G on the C7 Terminals. The same batteries can be used for both the amplifier and receiver. It should be determined that the Post G is not connected to the filament line of the receiver.

The elaborate Model K is not really required for the Model C Receiver if it is only desired to receive the standard broadcast wavelengths, 240 to 560 meters. A C7 Antenna Inductance can be located in the Model C Receiver, the terminals 1 and 3 connected to the loop posts in place of a loop and the Antenna and Ground connected to posts L and G.

In a similar manner the Model J Radio Frequency Amplifier can be added to any loop receiver. In this unit the output transformer is made a part of the amplifier. To connect the Model J to the Model C it is only necessary to connect the binding posts S S directly across to the loop posts, omitting the loop. Binding Posts are also provided to supply filament and plate current directly across; these posts are marked A Plus, A Negative and 90B. There is no necessity of a 90 negative post as this is connected to the A Plus. Two Jacks are provided in the J Model to insert a plug to which is connected a loop. Inserted in the first jack, the two stages of amplification are employed. In the second Jack these stages are cut out and the loop is directly connected to the C Set. In this last case, the Control Switch should be in the center position to cut off the filament current from the J tubes.

A J Model Amplifier can be connected in front of a C7 Receiver if desired. Referring to the diagram in Fig. 156, the transformer T-3 should be omitted, the Plate P of V-2 is run directly to the lower binding post S and the upper Binding Post S is run to the 90 volt Plus. When connecting this altered J Model to the C7 the two posts S and S are connected to the Posts L and G on the C7 Receiver. The lower S post should preferably run to post G on the C7. Care should be taken to see that post G is not connected to the filament line of the C7 Receiver.

When the C7 Receiver is operated as a unit by itself the post G can be connected to the Negative Filament line, but when operated in connection with a J or S Model, the connection between G and Negative A should be removed, if it is there.

Fig. 155 is J Tuning Unit consisting of a Low Loss Variable Condenser and Special Transformer. The J Model can be placed in front of a Neutrodyne set and with this combination a total of four stages of tuned

radio frequency is obtained. To accomplish this, wind ten turns of No. 20 B. & S. Copper wire over the secondary of the first Neutrodyne Transformer and run the start and finish to two binding posts on the left end of the Neutrodyne. In the J Model leave out the last Transformer T-3 and connect P or Plate of Tube V-2 direct to lower post S. Run upper post S to 90 Volts Plus. When using the two units together, connect the two new binding posts on the Neutrodyne to posts S S on the J Model. The ten turn winding added to the Neutrodyne should be spaced to occupy the same winding space as the secondary.

A layer of paper should be laid between the secondary and the ten turn winding. The same batteries can be used for the J Model and Neutrodyne.

When operating the J Model and it is found that the first dial tunes broad, it is an indication that the antenna is too long. Either reduce the length of the antenna or add a series antenna condenser. For those who like to tinker, the best antenna series condenser consists of a General Radio Type 247F Mounted Variable Condenser, the antenna run to the condenser and a lead from the condenser to the antenna binding post being used. After changing the antenna series condenser adjustment, the other tuning dials should be regulated to note the change. It will be found in practice that the smaller value of condenser used in series with the antenna, the sharper the tuning results, with corresponding decrease in signal audibility.

When it is desired to tune to wavelengths lower than the standard transformers allow, a few turns can be taken off of each of the secondaries of the Transformers T-1, T-2, T-3, the exact number of turns to be determined by experiment.

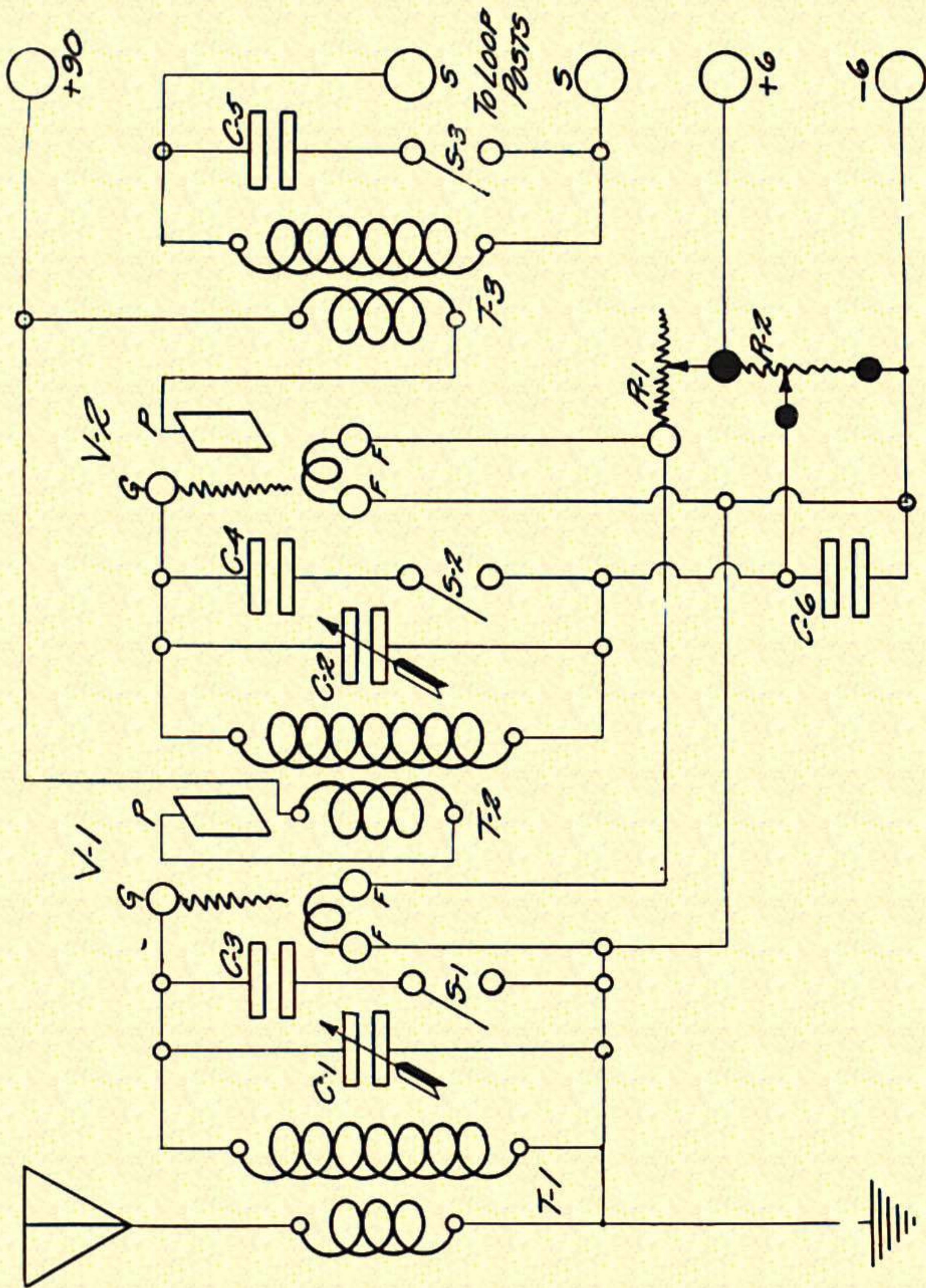

Fig. 156
Schematic Wiring Diagram of Model "J" Two-Stage Tuned Regenerative Radio Frequency Amplifier.

CHAPTER IV

PLIODYNE RECEIVERS

The standard Neutrodyne Receiver gives two stages of Tuned Radio Frequency Amplification, Detector and Two Stages of Audio Frequency Amplification, a total of five tubes. In some models only four tubes are used, the last audio stage being reflexed on the first radio frequency amplifier tube. During the 1923 Fall season this was the most popular method of reception, the sales of Neutrodynes probably exceeding those of any other type of receiver. There are three dials to tune the two stages of amplification and this is the outstanding disadvantage as an operator only has two hands, and the three dials must be moved proportionally to change from one wavelength to another. The Radio Frequency Amplifier is balanced by the capacity neutralizing method and this method does not neutralize completely enough to allow over two stages of amplification to be employed without making extensive shielding provisions. Furthermore the balance is very critical and if not properly adjusted the receiver will oscillate, particularly at the low end of the wavelength scale. This is not really a disadvantage as it actually adds regenerative amplification to the radio frequency amplifier, equivalent to adding one or two stages of further amplification. The oscillations, when existing do however cause radiation and the necessity of tuning to the zero beat method. The selectivity of the Neutrodyne is not anywhere as sharp as the selectivity obtainable when using Amplifying Transformers having an independent grid winding, as will be described further on.

The Pliodyne method of neutralizing or nullifying tube capacities is the invention of C. L. Farrand, formerly Chief Designer of the Marconi Wireless Telegraph Co. of America. (Fig. 163.)

The Pliodyne 6 was designed by the writer with the engineering cooperation of Mr. Farrand and is manufactured by Golden-Leutz, Inc., under Farrand and Hogan Licenses. This receiver is such an ideal instrument and its popularity is proving so great that the details are given in full and should prove very interesting to students of radio reception. There are two stages of non-regenerative Radio Frequency Amplification, Detector and three stages of Audio Frequency Amplification. The disadvantage of three dials is eliminated by tuning two amplifying transformers simultaneously through the medium of two separate condensers mounted on a single shaft. This feature is covered

by Hogan Patent No. 1,014,002 and the manufacturers are licensed under this patent.

It would not be possible to use the two condensers, situated so close to each other without shielding them electrically from each other. This feature of condenser shielding is covered by another Patent application of Farrand's.

The "Super-Pliodyne 9" a front and rear view of which is shown in Figs. 157 and 158 as manufactured by Golden-Leutz, Inc., was the first broadcast receiver in which several circuits were tuned simultaneously by a single dial. This design was drawn up by the writer about December, 1923, and at that time not another single manufacturer had advertised a receiver having this feature. Since then, however, this original feature of Golden-Leutz, Inc. has been widely copied by many manufacturers.

Tuned radio frequency amplification is known in engineering circles to be the best method for building up weak signals of long distance reception, and although most popular receivers on the market at this time employ two stages of tuned radio frequency amplification with detector and two stages of audio amplification, giving very good results, they are lacking in efficiency for bringing in the greatly desired, long range reception which is only possible with additional stages of radio frequency amplification.

Up to the present time no one has been able to design and manufacture a receiver containing more than two stages of tuned radio frequency amplification. There are two good reasons for this: *First*, the former systems of neutralizing the tube capacities would not hold effectively for more than two stages; *Second*, an individual dial was required for each stage and for the detector; that is, for five stages it would require six dials, making operation unreasonably difficult.

The "Super-Pliodyne 9" overcomes both of these difficulties with five stages of tuned radio frequency amplification operated by a single dial, and a vernier to compensate for differences in antennae. Through the use of the Farrand System of nullifying internal tube capacities five stages of tuned Radio Frequency Amplification are used to decided advantage and without any regenerative feed back or local oscillations.

The operation of the receiver is very simple, each station or wavelength has a definite position on the Kilocycle Dial and by turning this dial through a complete turn of 360 degrees the receiver is automatically tuned to each of the stations that are operating at that moment. One "Super-Pliodyne 9" located on Long Island, eight miles from New

York City, copied and actually logged 93 different stations in two evenings including KPO San Francisco, KFI Los Angeles and KGW Portland, Ore. All stations were of loud speaker audibility reproduced on a Western Electric 10D Loud Speaker. From a more favorable location in the central west undoubtedly twice this number of stations could be heard in the same length of time.

The use of dry cell tubes is not recommended at the present time for it has been found that the dry cell tubes available are not entirely satisfactory and will not give as good results as the storage battery tubes. While it would be possible to make a self contained receiver including batteries through the use of dry cell tubes, the receiving range and quality of reproduction would be seriously impaired.

The Left Dial marked "Vernier" is the compensating adjustment to take care of variations in Antennae. The "Kilocycle" Dial, or main tuning adjustment, is effective through the entire 360°. The Meter on the left is the Special Voltmeter and the other Meter is the Ammeter. The control between the two Meters is the Detector Filament Adjustment.

The right hand lower control regulates the Amplifier Tube Filaments indicated as "Master." The control to the left of this is the plate voltage regulating Potentiometer for the Detector. The Cutler-Hammer Control Switch is shown in the upper right hand corner. The two Loud Speaker Jacks are located at the right hand lower end of the panel and are designated "1" and "2". If a loop is desired it is connected between Antenna post "L" and ground, and tuned with the "Vernier" dial.

The Special Condenser can be seen aligned in its position and the gears adjusted. Particular note should be made of the wiring which, we believe, is the "neatest" wiring work done in any radio apparatus. The arrangement of wiring is a very important item and in this Receiver the final wiring arrangement was patiently worked out and all succeeding models are being wired as exact duplicates. All joints are locked or soldered and there is no possibility of any parts becoming loose in transit. This view also shows how the interior surfaces are lined with sheet copper for electrical shielding.

Cabinet removed clearly shows the sub-panel and at the extreme right the first Radio Frequency Transformer. Notice that a tube is mounted between each two sockets and that the relation of each Transformer to its neighbor is selected to reduce any stray coupling between Transformers. The Nullifying Resistors, Blocking Condensers

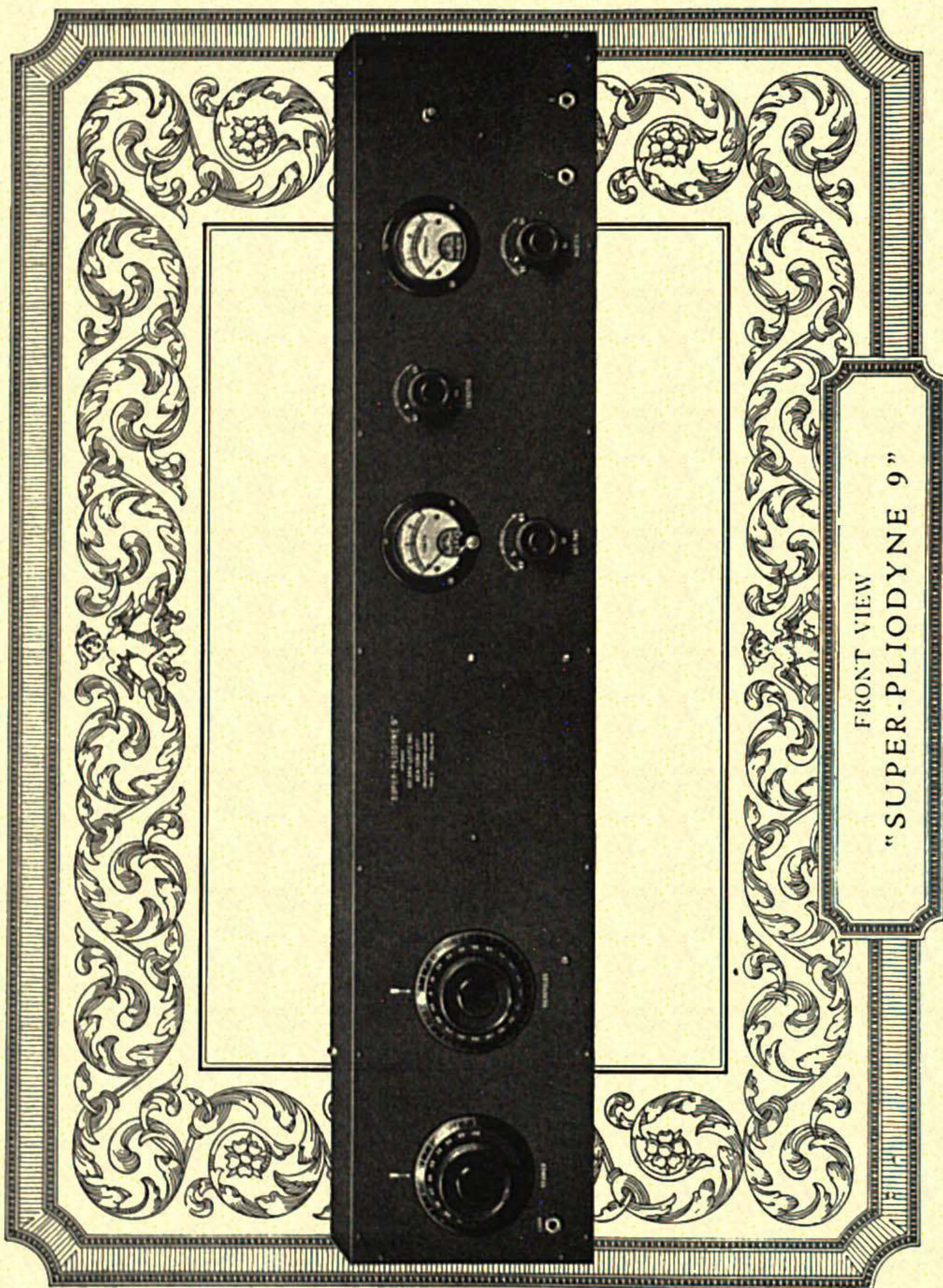

FRONT VIEW
"SUPER-PLIODYNE 9"

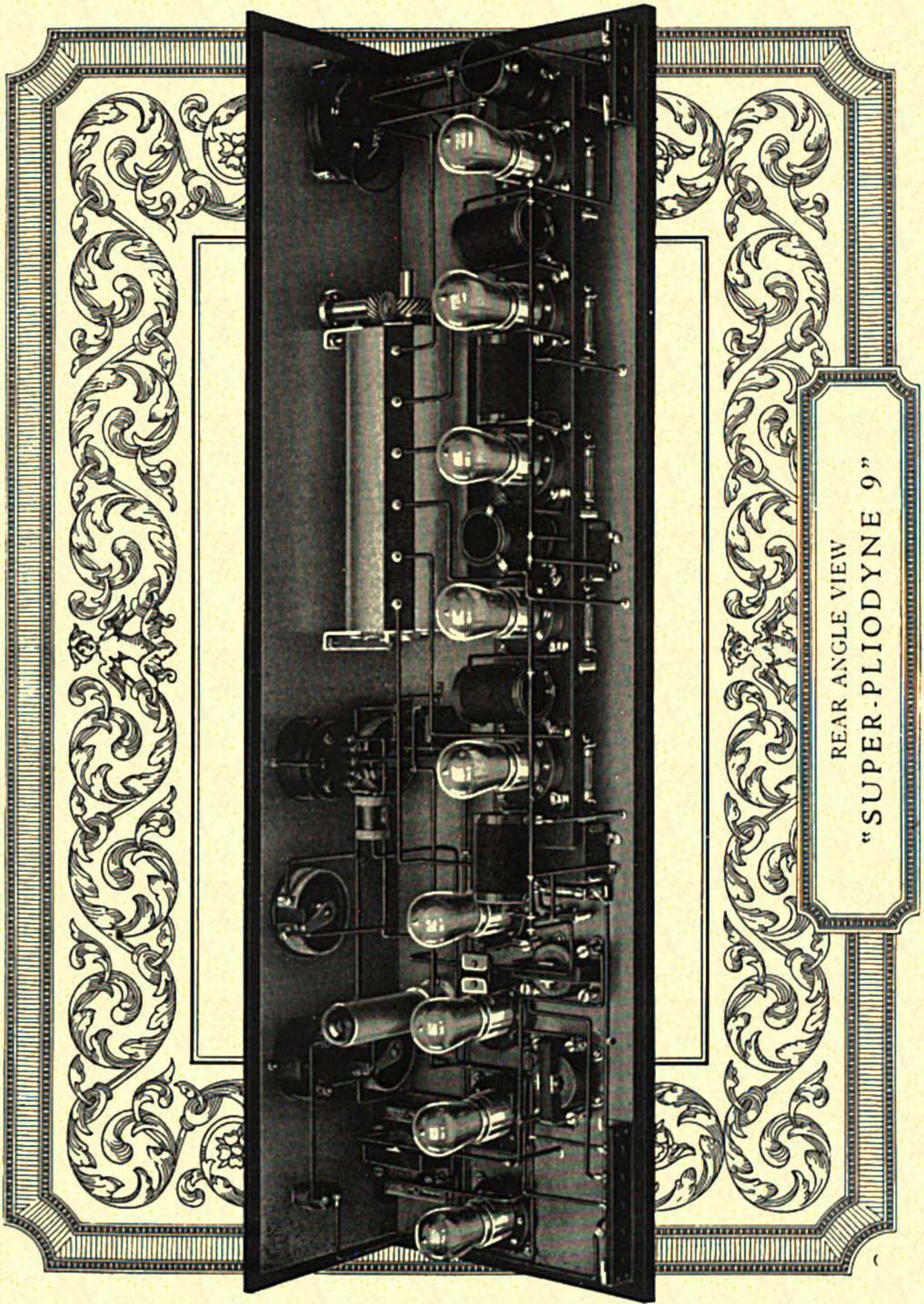

REAR ANGLE VIEW
"SUPER-PLIODYNE 9"

and By-pass Condensers are under the sub-panel mounted as units. The Audio Amplifier system is located at the left-hand end of the base.

All terminal Binding Posts are fastened rigidly to the base, making it possible to remove the cabinet during manufacture without disturbing any of the internal parts of the Receiver.

Fig. 160 shows the External Connections for the "Pliodyne 9" and Fig. 161 is the schematic wiring diagram of the entire Receiver. Incidentally while this shows a correct diagram to illustrate the circuits, this does not show the final wiring as used in the "Super-Pliodyne 9." The actual final wiring differs from this diagram and comparison will only tend to confuse you. Under no circumstances should any alterations or adjustments be made to any part of the Receiver. If the seal is broken the manufacturer's responsibility ceases.

SPECIAL MULTIPLE CONDENSER

There is a total of six condensers in this unit. Each condenser consists of a rotor unit on a shaft and a stator unit permanently fixed. The plates on the rotor unit are punched from brass and soldered to each other to form a single piece of metal of low contact resistance. The stator plates are assembled in a similar manner. These rotor and stator units are made specially for Golden-Leutz Corp. by the General Radio Co. employing their superior manufacturing methods. The separating barriers between the condensers and the end plates are machine punched from hard drawn 3/32 inch aluminum sheet. All the rotor units are connected together on a common accurate steel shaft. The stator units are insulated from the barrier and end plates by Grade P Natural Formica which insures a negligible electrical loss. The condenser plates are specially shaped to give a nearly uniform wavelength variation with respect to angular motion of the rotor plates. ●

The barriers are separated from each other by aluminum spacers and brass tie rods resulting in a very strong unit which will not get out of adjustment easily.● These condensers are adjusted by experts to check within one-quarter of one per cent of a standard at five points on the scale. The transformers are checked in a similar manner and this results in each stage of the amplifier tuning to the same wavelength with respect to angular movement of the Kilocycle Dial.

SPECIAL VERNIER CONDENSER

Inasmuch as no two antennae are alike, a means must be provided to compensate for the variations.

The instrument used for this purpose consists of a low loss variable air condenser (Fig. 3) in connection with a fixed inductance. The inductance is in inductive relation to the first radio frequency transformer.

When the antenna is connected on the S post, the vernier is not connected in the circuit and is not used. With the antenna connected on the L post the Vernier Dial must be tuned accurately for best results.

For long wave stations the short circuiting jumper on the primary inductance should be disengaged.

SPECIAL RADIO FREQUENCY TRANSFORMERS

The first Transformer consists of a secondary only and has a different electrical value than the others because it works in connection with the compensating Vernier.

The other five transformers have both primaries and secondaries. Each winding is wound on a Natural Formica Tube, one fitting inside the other.

German Litzendraht wire is used consisting of 10 wires each No. 38 B & S Gauge, enameled. This conductor of ten wires is insulated as a group by green silk twisting. The use of Litzendraht gives an inductance of very low high frequency resistance at short wavelengths, corresponding to high frequencies. The use of Natural Formica prevents any appreciable loss of the small currents being handled.

TUBE SOCKETS

General Radio Type 156 Socket is shown with a tube inserted in Fig. 34. The strong positive side contacts are clearly shown. When inserting tubes in this type socket the tube prongs must not be coated with lumps of solder. If there is an excess of solder on the prongs it should be removed with a sharp knife, before inserting the tube in the socket. In our factory the metal shells of the sockets are grounded to the negative A Battery line.

RHEOSTATS

General Radio Type 214A (Fig. 35) Rheostat and Potentiometers are used in the "Super-Plidyne 9." These rheostats are of excellent design. The mounting base is of moulded Bakelite, heat resisting and non-warping. The metal parts are of brass heavily nickel plated. The resistance wire has a zero temperature coefficient and wound by a special method that prevents the wire from loosening at any time. All wires are of the proper resistance and current carrying capacity.

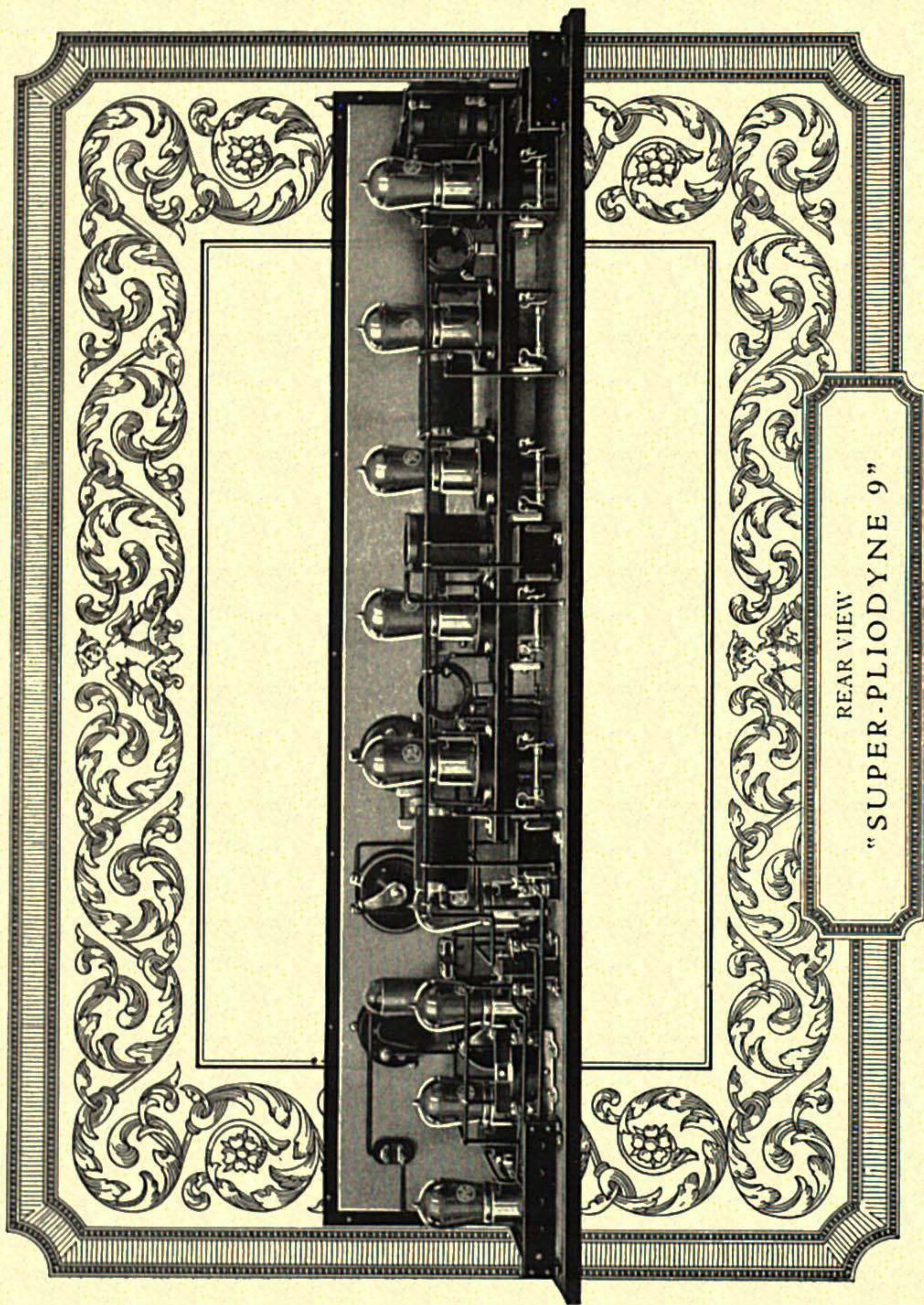

REAR VIEW
"SUPER-PLIODYNE 9"

One Rheostat is provided for the Detector and a Master Rheostat is provided for all the Amplifier tubes. A potentiometer is supplied to regulate the Detector Plate Potential when using UV200 Detector.

THE VOLTMETER AND AMMETER

The special indicating meters used on the "Super-Plidyne 9" (Fig. 33) are manufactured by the Weston Electrical Instrument Co. for Golden-Leutz, Inc. The Voltmeter has two scales, one reading 0 to 7.5 volts and the other 0 to 150 volts. The lower scale is to read the tube filament voltages and the upper scale to read the plate battery voltage as supplied to the receiver. To read these voltages a four-point selector switch is provided and in the different positions reads as follows:

1. Voltage of A Battery, should show about 6 volts or slightly over when fully charged.
2. Voltage supplied to the Detector Tube Filament which will run from 4 to 6 volts depending upon the individual tube used and the plate battery voltage used in connection with the detector tube.
3. Voltage applied to the amplifier tube filaments, usually about $5\frac{1}{2}$ to 6 volts depending upon condition of the filament battery.
4. Voltage applied to the amplifier tube plates, this depends upon the B Batteries connected to the receiver and the condition they are in. This reading should be at least 90 volts for good operation and may be as high as 120 to 130 volts with increased signal strength. The ammeter has a 0 to 5 scale and the reading is normally $2\frac{1}{4}$ amperes when using UV201A throughout or 3 amperes when using a UV200 Detector.

AUDIO TRANSFORMERS

The General Radio Type 231A Audio Transformers Fig. 32 are used in the "Plidyne 9." These transformers are the result of expert design and give maximum amplification without distortion over a very wide range of frequencies. The windings are extra heavy and there is no danger of burned out coils. Each transformer is run through a series of tests before assembling in a receiver.

FIXED CONDENSERS

Dubilier Fixed Condensers (Figs. 38 and 39) are used exclusively in this receiver. There are five type 601 Blocking Condensers, three 1 MF Radio Frequency By-Pass Condensers, one Type 600 ByPass, one type 60' Grid Condenser. Each condenser is tested for capacity and dielectric strength before placing in a receiver.

JACKS AND PLUGS

The Jacks used in this receiver are of the Premier Type (Fig. 40) and found to be the finest and most reliable telephone Jack manufactured. These Jacks are adjustable and each one is properly adjusted to a Weston Plug during assembly.

WINDING TRANSFORMERS

A battery of winding machines is employed that turn out the special transformers. Each coil when finished is inspected and tested to insure that not even one of the ten wires in a strand is broken. If one or more strands are broken the coil must be rewound. The second test is to insure that the coil has the proper electrical value within given limits. If the value is high it can be adjusted by subtracting, but if it is low it must be rejected and rewound.

PANEL ENGRAVING

All Panels are engraved at the Golden-Leutz factory by a battery of eight Gorton Engraving Machines, each being equipped with individual motor drive. The lettering to be reproduced is copied from a master, usually six times as large as the finished work. The reduction is effected through a pantograph arrangement. The cutter revolves at approximately 3,000 revolutions per minute and cuts a V-shaped groove about 5/1000 of an inch deep.

A graph, indicating the wavelengths, plotted from the Dial divisions on the "Kilocycle" Dial is furnished with each Receiver. This curve is only typical, as each individual Receiver has a curve different than the others, although in some cases the difference is very slight.

It is impossible to make an accurate calibration against Broadcasting stations as the Broadcasting stations change Wavelength from time to time. For example some night WDAP in Chicago is lower in Wavelength than WHN, other times WDAP tunes higher in Wavelength than WHN and at other times they are less than 2,000 cycles apart causing an audible beat "whistle" between the two carrier waves. Another example is WIP and WOO both in Philadelphia and both supposed to be on 509 meters yet actually they are several meters apart. Accordingly the best plan is to note the Dial divisions for different stations and plot a Graph for your particular Receiver and for stations within your range. A blank Graph for this purpose is provided with each Receiver. Ruled Calibration Sheets are also provided with Receivers.

SPECIFICATIONS OF THE "SUPER-PLIODYNE 9"

Cabinet—Solid African mahogany, dimensions 40 inches long by 8 inches high by $10\frac{1}{4}$ inches deep. Manufactured from carefully selected bone dry half inch stock. Top equipped with heavy nickel-plated full length piano hinge, and back catch. Exterior surfaces hand polished to a dark piano finish. This cabinet is made to our special requirements by one of the finest cabinet makers in the East.

Panel—Genuine Grade "M" Black Formica, size 40 inches by 8 inches by one-quarter inch. All mounting holes in the panel are located from steel drilling jigs and accurately cut to proper sizes. The front surface is given a dull satin finish through a combined Peerless Grinding Machine and hand grinding process. The use of this grade of Formica insures the highest insulating qualities combined with negligible electrical losses.

Shielding—The entire interior surfaces of the cabinet and panel are lined with 12-ounce soft drawn pure copper sheet. This prevents undesirable coupling from wires and apparatus external to the receiver proper. While shielding is used extensively in commercial and governmental apparatus, this is the first broadcast receiver to incorporate this advantageous feature.

Engraving—The main front panel and rear terminal blocks are lettered by the Gorton Machine process which is standard on high grade electrical apparatus. This results in engraved white lettering on the black satin finish panels.

Tuning Control—There is only one main tuning control. This control through a 2 to 1 Helical Reduction Gear actuates six separate condensers on a common shaft. By turning this "KILOCYCLE" Dial any wavelength may be selected instantly from 250 to 575 meters.

Vernier—A "Vernier" Dial is provided to give an individual adjustment on the first Radio Frequency Transformer to compensate for the use of various sizes of antennae and for the use of an indoor loop.

Wavelength Range—This receiver will tune accurately to Broadcasting stations working on wavelengths from 250 to 575 meters which includes all the important Broadcasting stations in the United States.

• **Selectivity**—When receiving stations of equal signal intensity the receiver will differentiate within one per cent in wavelength. With a test receiver located one-half mile from WEAFF which operates on 492 meters, Philadelphia on 509, Detroit on 517, Omaha on 526, Chicago on 536 and St. Louis on 546 meters have been received without the slightest

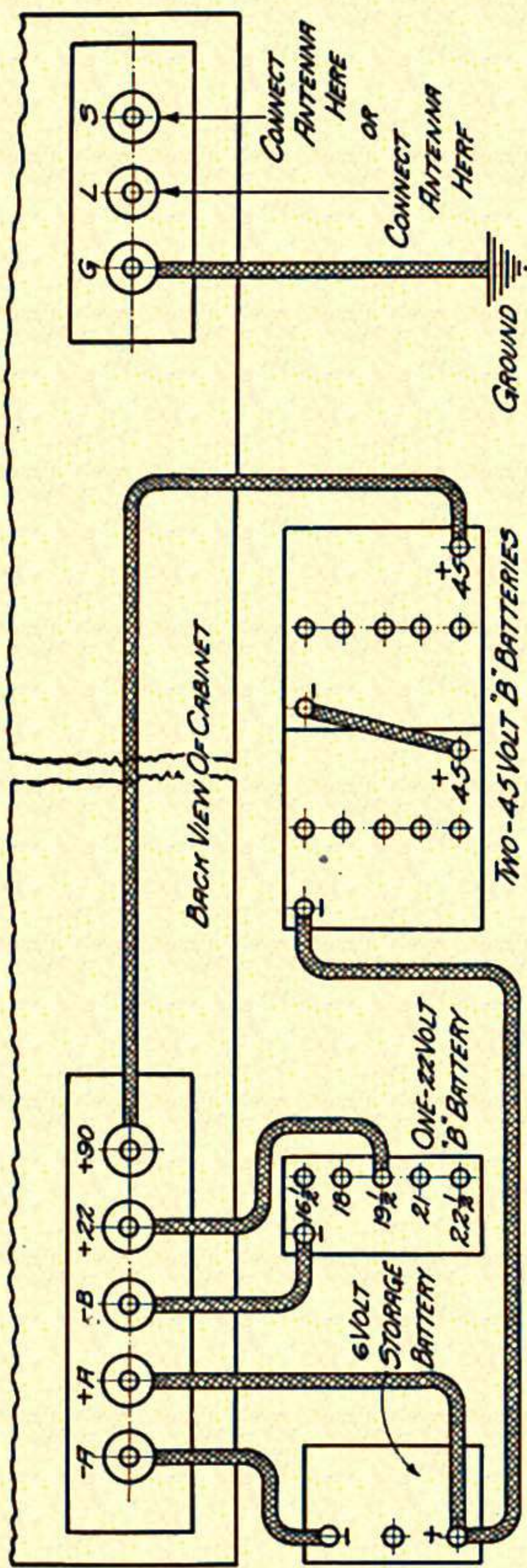

Fig. 160

External Connections Golden-Leutz "Pliodyne 9"

interference from WEAJ. Using a test receiver in the suburbs of New York City KGO Oakland, Calif., has been received clearly through Cincinnati, a difference in wavelength of approximately 3 meters.

Tubes—Radiotron UV201A should be used throughout. A Radiotron UV200 Detector may be used if desired.

Detector Rheostat—Provided to give an accurate filament adjustment to the detector tube. Wound to suitable resistance to regulate either a Radiotron UV201A tube or a Radiotron UV200 Gassy Detector. General Radio Type 214A, Moulded Bakelite Base, Moulded Bakelite Knob, zero temperature coefficient rustless resistance wire.

Master Rheostat—Provided to regulate the five radio frequency and three audio frequency amplifier filaments simultaneously and wound to suitable resistance and current carrying capacity. General Radio 214A.

Potentiometer—This instrument is inserted in the Detector circuit to provide a close adjustment on the Detector Plate Voltage when using a Radiotron UV200 Gassy Detector. Moulded Bakelite Base, Moulded Bakelite Knob, zero temperature coefficient resistance wire, enameled, wound to proper ohmic value.

Indicating meters—A double scale Weston Voltmeter is provided to enable following readings:

1. Voltage of "A" Battery.
2. Voltage applied to Detector Filaments.
3. Voltage supplied to Amplifier Filaments.
4. Plate Voltage supplied to Amplifier Tubes.

A special four-point switch enables the change to any of the four readings. The voltage scales on the meter are 0 to 7.5 volts and 0 to 150 volts. An ammeter is provided to measure the total filament current consumption from the "A" Battery. Both meters are Model No. 301 manufactured by the Weston Electrical Instrument Co. specially for this receiver.

Multiple Condenser—This special instrument consists of six individual condensers mounted on a common steel shaft. The plates of each condenser are made of brass properly soldered as a unit insuring very low contact resistance. Each one of the individual condensers is shielded from the other through the use of barrier plates. The stator plates are insulated in accordance with the latest research data on that subject, resulting in a complete condenser having practically no electrical losses. The unit is self contained in a heavy aluminum case.

Sub-Panel—The five Radio Frequency Amplifier Tubes and their transformers are mounted on a sub-panel of Grade M Black Formica 24 inches by 3 inches by one-quarter inch. On the under side of this panel are mounted the nullifying resistors, blocking condensers and bypass condensers, also the bus wiring for these five tubes.

Nullifying System—To prevent oscillations or any regeneration in the Radio Frequency Amplifier bank, the Farrand System of nullifying tube capacities is used under a license agreement. This system has the advantages of being applicable to more than two stages of radio frequency amplification, the adjustments are not critical in relation to tube capacities and the nullifying effect is just as effective at short wavelengths as it is at high wavelengths.

Compensator—A Compensator in the form of a hot wire resistor is connected in series with the Radio Frequency Amplifier tube plates. An increase in plate voltage at the terminal block will increase the voltage applied to the audio frequency amplifier tubes, but the compensator will limit the voltage applied to the Radio Frequency Amplifier tubes and prevent improper operation automatically.

Condenser—Special General Radio Type 247V low loss straight line shaped plates. Brass conductors soldered. The best obtainable.

Terminals—All terminals are in the rear of the cabinet, and consist of heavily nickel-plated brass binding posts. The various connections are designated by engraved lettering on Black Formica Nameplates.

Jacks—Premier Adjustable Jacks are provided to enable the loud speaker to be inserted at two points, one point supplying two stages of audio amplification and the other point supplies three stages of audio amplification. A Jack is also provided to enable a Loop Plug to be inserted. Weston Telephone Plugs should be used in connection with these Jacks.

Sockets—General Radio Type 156 Sockets are used throughout. The base is moulded of heat resisting Bakelite. The shell is made of seamless heavy brass tubing heavily nickel plated. The Tube Prong Contacts are punched from special spring bronze and give a positive side contact unobtainable in any other type of socket.

Switch—A Cutler-Hammer Switch is provided and this switch when in the off position disconnects the entire receiver without touching any other connections.

Gearing—The Multiple Condenser is controlled by the KILOCYCLE Dial through two Helical Gears having a 2 to 1 reduction ratio,

accordingly a very fine tuning adjustment can be made on this tuning dial. One of the gears is machined from soft steel and the other from Formica Canvas, providing a combination that is very smooth running and noiseless. Each of the two shafts has extra heavy brass bearings and proper provision made for occasional lubrication.

Wiring—All connections between units is with No. 12 tinned copper wire covered with General Electric Insulating Tubing. Alcohol and rosin is the only soldering flux used.

Dials—The two dials used are punched from heavy sheet brass and etched a deep satin black with white silvered graduations. The Vernier Dial is graduated from 0 to 100 and the Kilocycle Dial graduated from 0 to 200. The use of metal for the dial extends the shielding externally and prevents warping which is common with all moulded dials. The knobs are Moulded Black Bakelite with a tapered surface to fit the hand comfortably when tuning.

Radio Frequency Transformers—The Radio Frequency Transformers are wound on Natural Formica Tubing to prevent electrical losses. The windings are Silk Covered German Litzendraht Wire, each conductor being composed of 10 No. 38 enameled copper wires twisted together and then covered with the green silk outer coating. In terminating these wires special processes are employed to ensure proper contact to each of the ten wires fully and without any breakage. The use of Litzendraht is very expensive but is an excellent method of excluding electrical losses in inductances used at low wavelengths. The mechanical mounting arrangement between transformers prevents inter-coupling.

Fixed Condensers—All fixed condensers are supplied by the Dubilier Condenser and Radio Co. The products of this company are standard on all commercial and government apparatus. All condensers and other individual parts are tested separately to pass certain limits before assembling in the receiver proper.

Audio Frequency Transformers—The 1st and 2nd Stage Audio Transformers are made by the General Radio Co. known as their Type 231A and they give perfect reproduction without distortion. The 3rd audio transformer is of special manufacture and design to prevent any possibility of distortion. The audio circuit is so arranged that bias batteries are not required.

Receiving Range—Normally 1,500 miles using a 30-foot indoor antenna, normally 2,000 miles using a 3-foot indoor loop and approximately 3,000 miles using a 75 to 100 foot outdoor antenna clear of steel build-

ings. These ranges are based on receiving from 500 watt Broadcasting stations and with Loud Speaker reproduction at the receiver.

Batteries—A six-volt storage battery is required for the filament line, 80 to 110 ampere hour is sufficient for two weeks' operation. A 90 to 120 volt B Battery is required for the plates of the tubes. Two 48-volt 5-ampere hour storage battery sections are suggested. When using a UV200 Detector a separate 22½-volt battery is recommended for the Detector plate.

Antenna—For ordinary purposes an indoor antenna consisting of a single strand silk covered lamp cord 30 feet long can be strung along the picture moulding. For longer receiving ranges an outdoor antenna consisting of 75 to 100 feet of antenna wire stretched clear of surrounding objects and as high as possible will afford an excellent antenna. A suitable ground connection can be had by connecting to water or steam pipes, preferably the former. When using the small wire antenna the ground connection is not important.

If it is desired to use a loop, the Radio Corp. Type AG1380 loop is of the proper size and capacity. An Indoor Antenna is preferable to any loop.

Weight and Packing—The receiver proper weighs 55 pounds net. The receiver is packed in a strong corrugated carton and sealed. This carton is packed in a heavy wood packing case 48 inches long, 18 inches high and 18 inches wide, the space between the carton and case being carefully filled with clean excelsior. In this manner domestic shipments are made to any part of the country with safety.

Instructions—A complete Instruction Book showing the proper care and operation of the Receiver is supplied with each Receiver.

Guarantee—Guarantee each Receiver for a period of one year to be free of all defects of workmanship and material provided the seal is not broken and that the instrument has not been used in any manner other than described in the instruction book.

"PLIODYNE 6"

• The "Pliodyne 6" (a front and rear view of which is shown in Figs. 164 and 165) was designed to meet all competition in quality small sets. The simple operation is ideal only two dials used compared with three for most five-tube sets. The audio amplifier is constructed using special audio transformers which give very clear and true reproduction. The tuning is very sharp and consequently the selectivity is

INSTRUCTIONS: BOTH DIALS TUNE CLOSE TO THE SAME DIVISION FOR A GIVEN WAVE LENGTH, FOR EXAMPLE, 36° ON THE FIRST DIAL AND 41° ON THE SECOND DIAL, WITH THE SWITCH ON TAP #1. FOR GREATER SELECTIVITY OR FOR RECEPTION OF LOW WAVE LENGTHS, TAP SWITCH SHOULD BE ON TAP #1 OR #2. WHEN CHANGING SWITCH TAPS, ALWAYS RETUNE 1st DIAL WITHIN THE SET AS A SERIES ANTENNA CONDENSER AND SWITCH OPEN THIS SWITCH FOR GREATER SELECTIVITY.

A SENSITIVE DETECTOR ADJUSTMENT IS VERY IMPORTANT AND THIS IS OBTAINED BY TRYING DIFFERENT VOLTAGE TAPS ON THE #766 BATTERY, USING 16 TO 22½ VOLTS AND TRY FOR A CLOSE FILAMENT ADJUSTMENT WITH EACH TRIAL OF BATTERY VOLTAGE, USING THE UV200 DETECTOR RADIOGRAM.

IMPORTANT! THESE INSTRUCTIONS MUST BE FOLLOWED EXACTLY FOR PROPER OPERATION OF THIS SET.

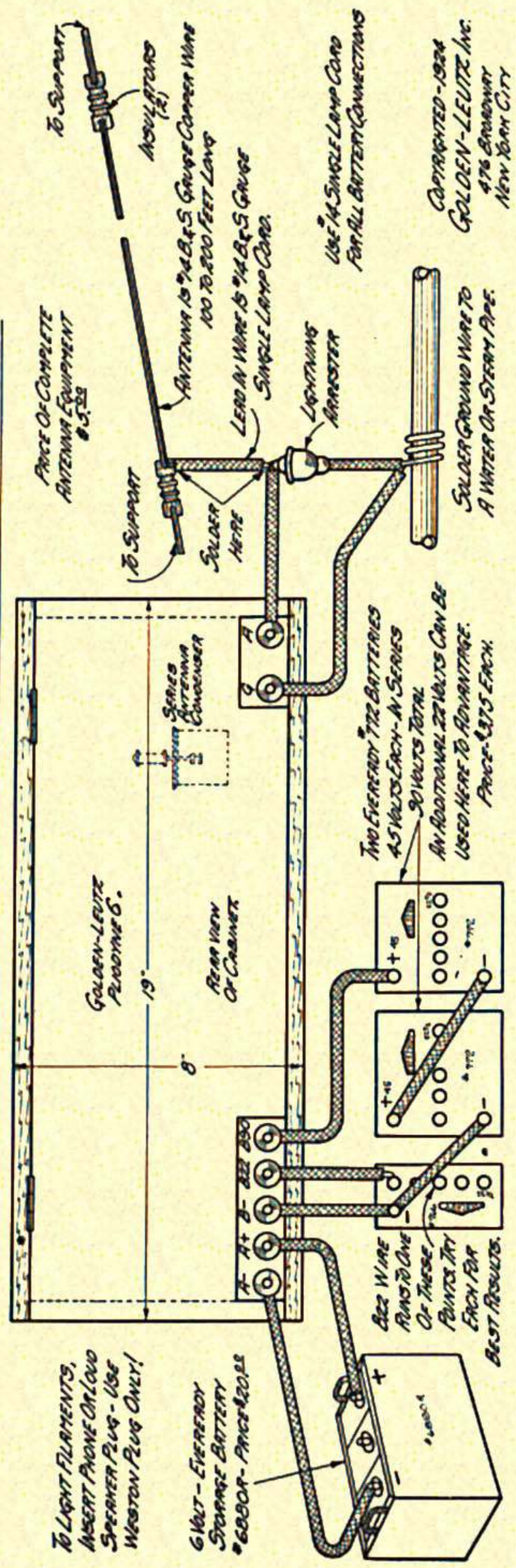

Fig. 162

Instructions and External Connections for Golden-Leutz "Pliodyne 6."

Insert tubes as follows, from left to right looking at front of panel, 1st, 2nd, 3rd, 4th, 5th tubes UV-201A or C-300A, 6th tube UV-200 or C-300.

high. The extra tube which is the third audio amplifier is a decided advantage for loud speaker operation of relatively weak signals.

The circuit is absolutely non-regenerative and cannot be made to regenerate or oscillate, accordingly it will not interfere with neighboring receivers in any way. External connections are shown in Fig. 162 and a schematic wiring diagram of the complete Receiver is shown in Fig. 166.

SPECIFICATIONS

Cabinet—African Mahogany, dark Polished finish.

Panel—Genuine Grade M Black Formica 19"x8"x $\frac{1}{4}$ " Grained to Satin Oiled Finish, U. S. Navy Standard.

Engraving—Gorton Machine Engraved by experts, White lettering, U. S. Navy Standard.

Dials—Black moulded one piece, engraved white lettering, 4" diameter with heavy tapered Knob, 2 $\frac{1}{2}$ " diameter.

Antenna Switch—Three point Laboratory type, heavy spring Bronze contacts, brass buttons, Bakelite Knob, nickeled metal parts.

Rheostat—For Amplifier Tubes, internal automatic regulating—for Detector, special heavy duty type.

Jack—Heavy Brass Frame, Spring Bronze Arms, Silver Contacts, Nickel Plated Finish.

Antenna Condenser—Special Construction, shaped plates for straight line wavelength variation, General Radio Type 247 stator and rotor units, low loss rigid.

Multiple Condenser—Special Construction, shaped plates for straight line wavelength variation, General Radio Type 247 stator and rotor units, low loss, entirely shielded and the two condensers shielded from each other, counterbalanced.

Tube Shelf—Genuine Grade M Black Formica $\frac{1}{4}$ " thick, grained. U. S. Navy Standard.

Sockets—Moulded-black, with square base. Positive contact, bronze contacts.

• **Radio Frequency Amplifying Transformers**—Special design having three windings. Low loss secondaries, all windings moisture excluded and properly baked. U. S. Navy Standard. Formica winding forms.



Fig. 163

C. L. Farrand, Inventor of the Pliodyne Method of Reception. With the Original Golden-Leutz Super-Pliodyne 9, December, 1923.

Audio Frequency Amplifying Transformers—Special Construction to give uniform and true reproduction over the range of musical frequencies.

Fixed Condensers—All Dubilier, U. S. Navy Standard.

Binding Posts—Solid Brass Heavily Nickel Plated, located at rear of cabinet and provided with Black Formica Name Plates.

Connecting Wires—No. 12 B & S Soft Drawn Tinned Copper Wire. U. S. Navy Standard.

Wiring Insulation—General Electric Insulating Tubing. U. S. Navy Standard.

Soldering Flux—Alcohol and Rosin Flux exclusively. U. S. Navy Standard.

Hardware—Solid Brass Heavily Nickel Plated, non-rusting, non-magnetic.

Radio Frequency Amplification Factor—10 per stage, two stages, absolutely free from regeneration.

Audio Frequency Amplification Factor—20 per stage, three stages, distortionless.

Radiation—Free from regeneration or oscillations will not cause interference with neighboring receivers under any circumstances.

Volume—Used with an outdoor antenna will give loud speaker volume from stations 2,000 to 3,000 miles or more depending upon location and conditions, absence of static, etc.

Sensitiveness—Used with a 50-foot indoor antenna, loud speaker signals can be obtained up to about 1,000 miles during favorable weather.

Manufacture—All manufacturing operations are in accordance with highest principles and methods. All experienced radio mechanics. No piece work operations. All inspections and final tests supervised by men experienced on U. S. Navy apparatus standards.

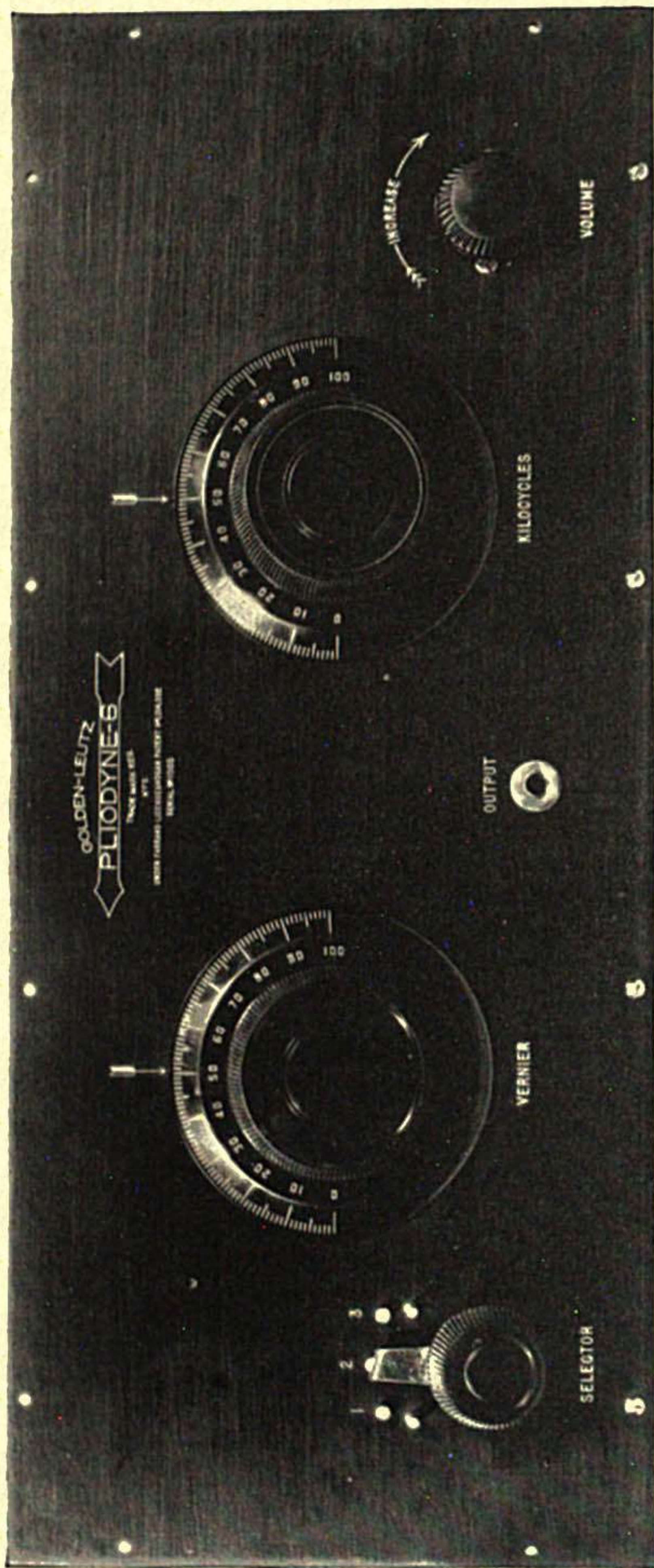

Fig. 164
Front View, Golden-Leutz "Pliodyne 6"

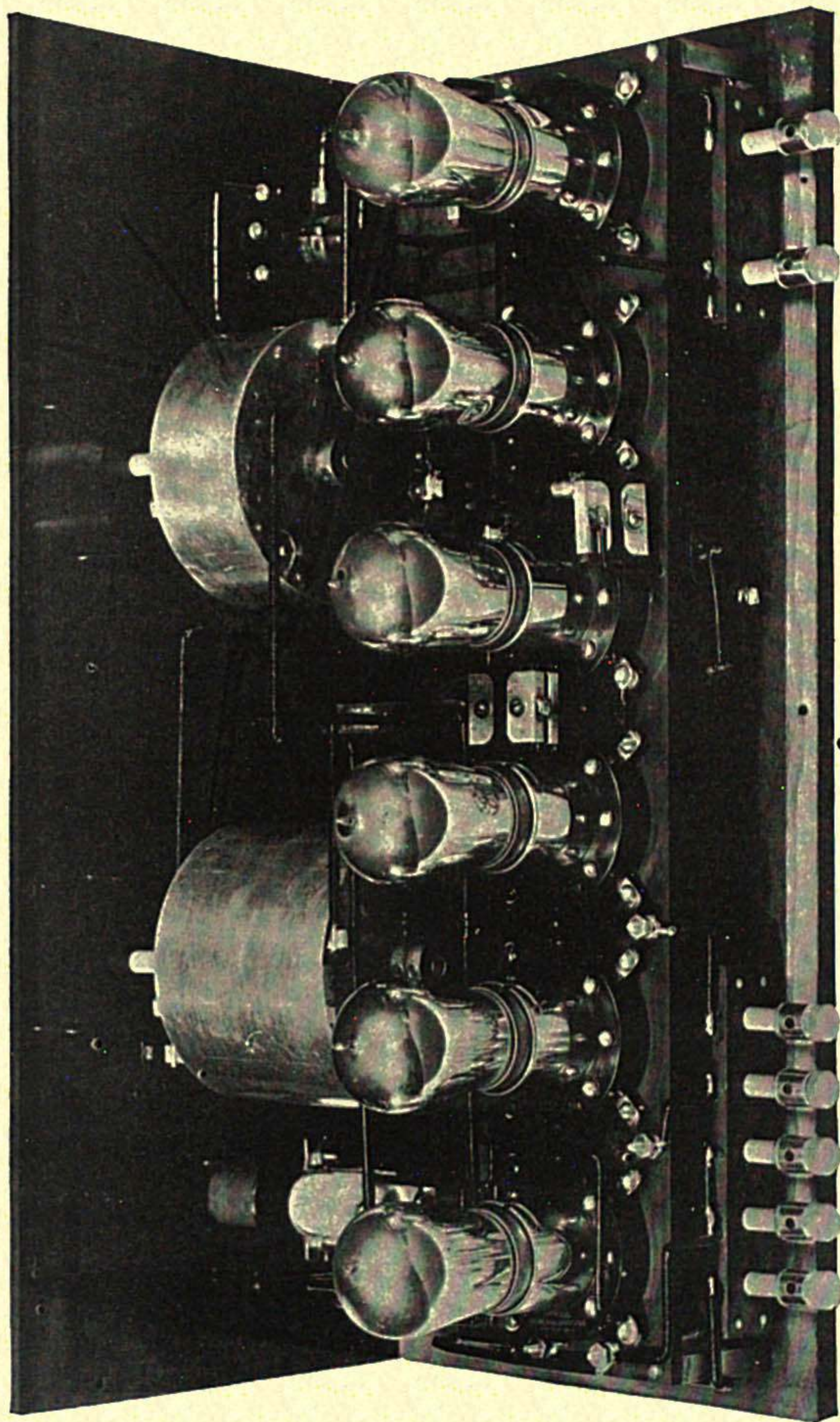
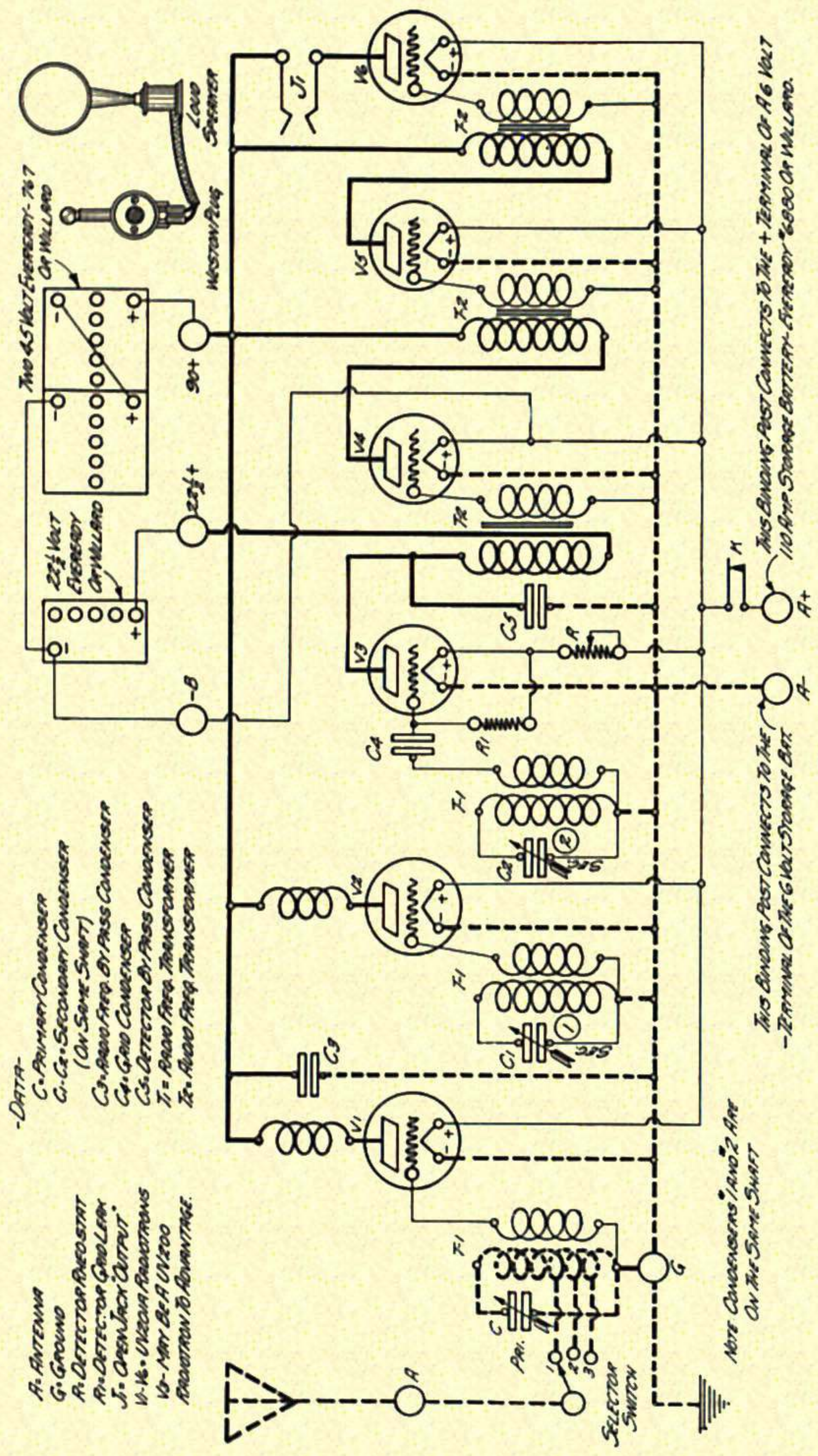

Fig. 165
Rear View, Golden-Leutz "Pliodyne 6," Cabinet Removed



-DATA-

C. PRIMARY CONDENSER
 C1-C2. SECONDARY CONDENSER
 (ON SAME SHAFT)
 C3. RADIO FREQ. BY-PASS CONDENSER
 C4. GRID CONDENSER
 C5. DETECTOR BY-PASS CONDENSER
 T1. RADIO FREQ. TRANSFORMER
 T2. AUDIO FREQ. TRANSFORMER

A. ANTENNA
 G. GROUND
 R1. DETECTOR RHEOSTAT
 R2. DETECTOR GRID LEAK
 J1. CHEN-JACK OUTPUT
 V1-V6. VACUUM RADIOTRONS
 V3-MAY BE A UN1200
 RADIOTRON TO ADVANTAGE.

NOTE CONDENSERS 1 AND 2 ARE
 ON THE SAME SHAFT

THIS ENDING POST CONNECTS TO THE
 - TERMINAL OF THE 6 VOLT STORAGE BXT.

THIS ENDING POST CONNECTS TO THE + TERMINAL OF A 6 VOLT
 110 AMP STORAGE BATTERY-FIREFLY-76800 OR WILLARD.

Fig. 166

Internal Wiring "Plodyne 6." Schematic Diagram, not actual. In actual set last tube to right (V-3) is the detector

CHAPTER V
LABORATORY EQUIPMENT



Fig. 167

Interior view of the Meginniss Radio Control Table. The Storage A and Storage B Batteries are contained within the table. Each battery is individually fused. A Tungar Charger is provided and so arranged to charge either the A or B Batteries. Upon lifting the top of the table, the main bus connections are automatically broken and leads to the receiver opened. In this manner the batteries can be readily filled with distilled water every two weeks. The batteries rest on slats and under the slats is a sand tray to take care of any possible leakage. Ventilation is provided to prevent charging gasses from accumulating under the top of the table. The table is constructed of mahogany and the top finished with inlaid battleship linoleum. All the wiring is carried out in a neat permanent manner and the wire used is oversize to take care of an emergency.

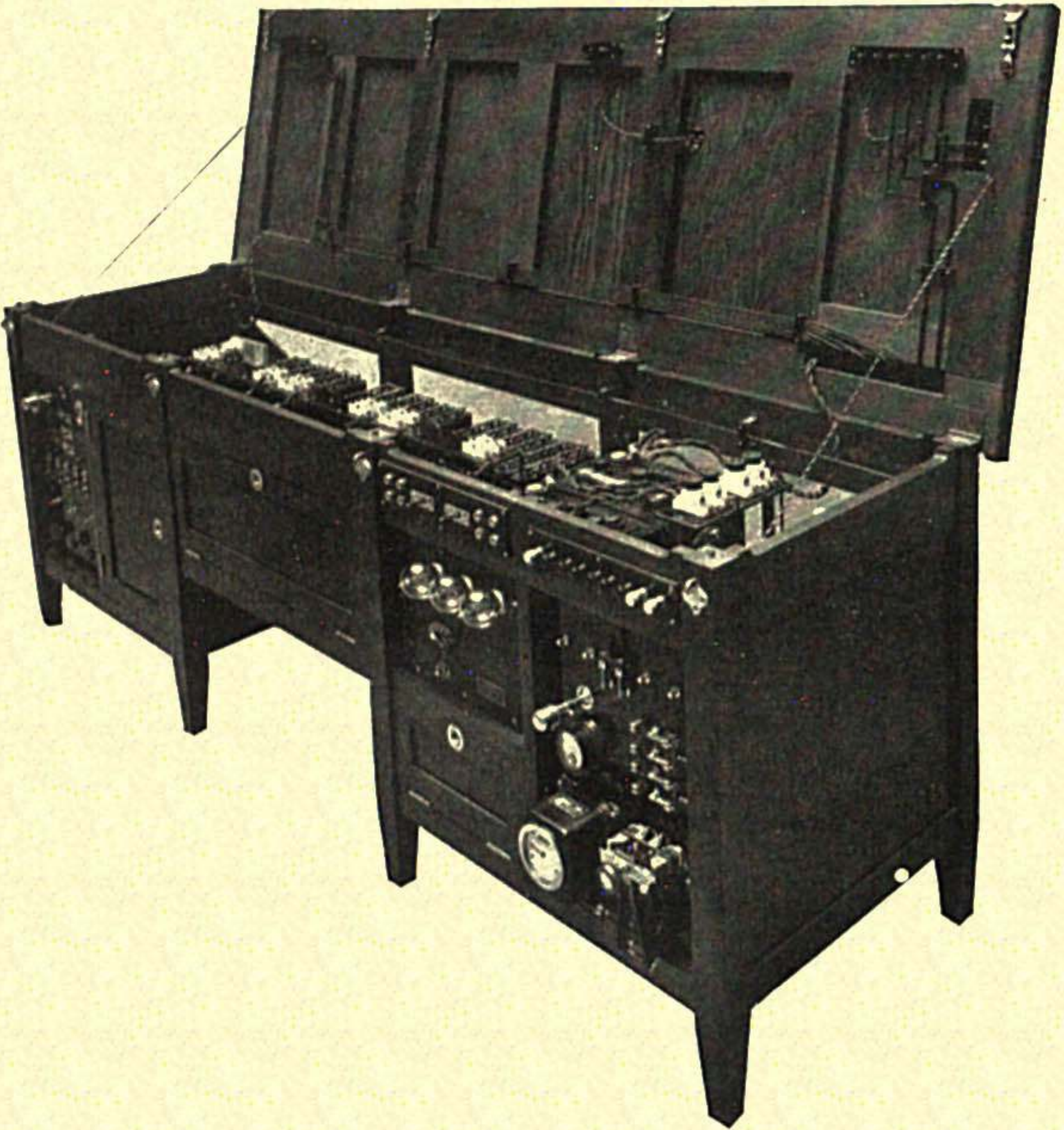

Fig. 168

In order to use all the B batteries continuously regardless of the voltage required, the total bank of batteries are all in series with a variable resistance. In this manner each cell contributes to the total voltage and the drop in voltage occurs at the resistance. A separate battery is likewise provided for the Detector Circuit and another separate battery for the Power Amplifier Unit. Separate A batteries are also provided for the Main Receiver and Power Amplifier Unit. The B battery control board is located to the left, A battery switchboard to the right and the Power Amplifier to the right also.

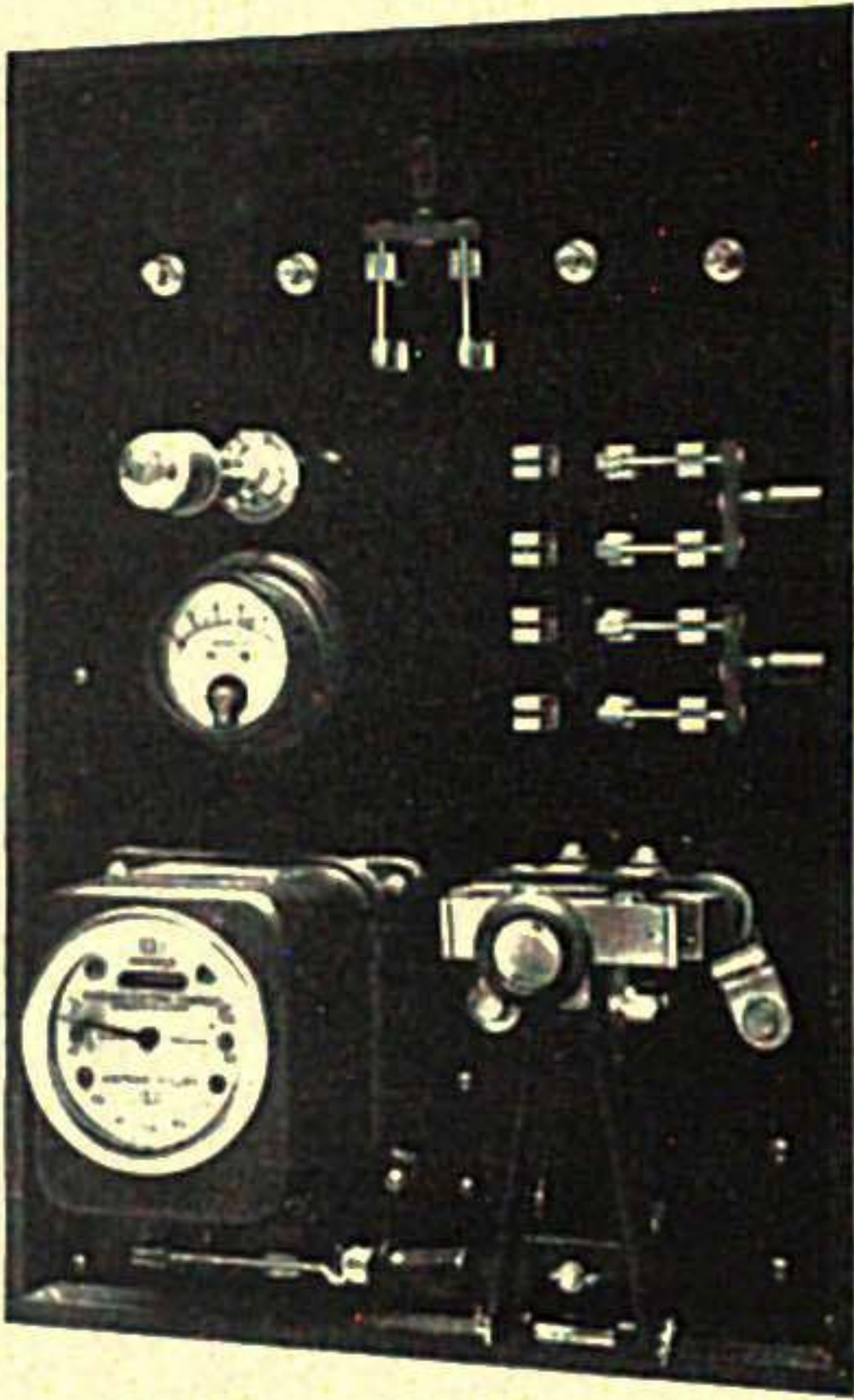

Fig. 169

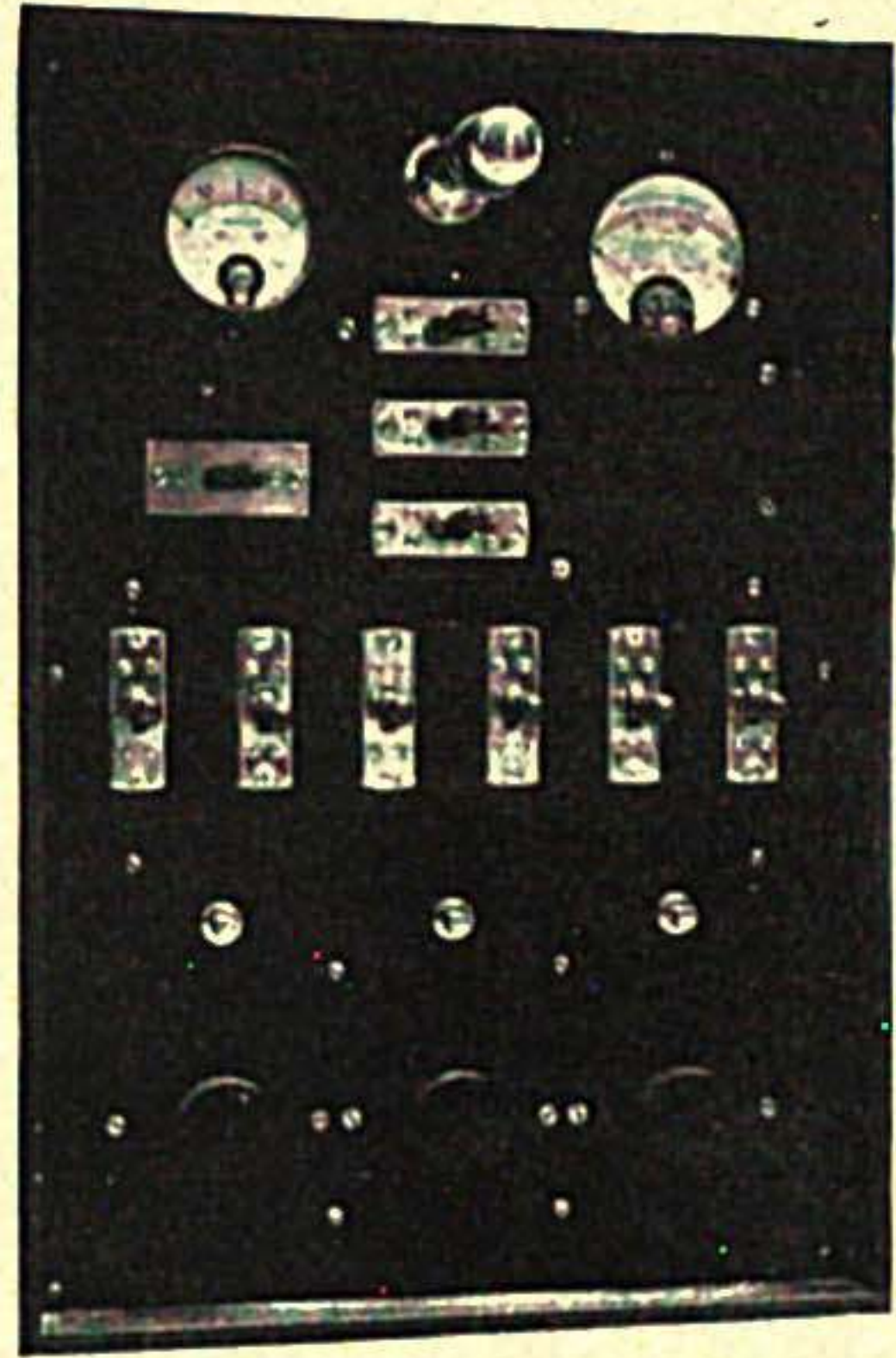

Fig. 170

The above two cuts show the A Battery Panel with Charging Equipment and the B Battery Panel to the right. The charging is so arranged that the Ampere Hour meter can be set for any desired charge, say 100 ampere hours and when that charge has been reached, the meter automatically opens the circuit by opening the circuit breaker. In a similar manner the ampere hour discharge is always indicated on the ampere hour meter and the condition of the battery can be instantly noted. An ammeter is provided to note the charging rate in amperes.

On the B Battery Panel the three lower knobs are the variable resistors which give fine regulation to the amplifier, detector and power amplifier B voltages. The other switches are to enable readings of any particular section of B Batteries and to give different distribution of voltages.

THE STORY OF THE VARIABLE CONDENSER

Do you appreciate the importance of the variable condenser in Radio? It was by connecting a condenser to an inductance, that Sir Oliver Lodge formed the first tuned radio circuit, the application of which made possible the advance of wireless telegraphy from the laboratory into the commercial field.

A rotary plate condenser was patented in 1893 by a German, named Korda. For radio use, however, variable condensers first made their appearance about 1902. The earlier forms consisted of two concentric cylinders, one of which was movable; then came the sliding plate types, and finally the rotating plate. The improvements during the next ten years were mostly mechanical, and it was only with the introduction of undamped wave transmission that the importance of reducing the power losses in condensers began to be appreciated. Therefore, the next step forward in condenser development was the design of a condenser in which these losses—largely due to "dielectric absorption" in the material insulating the rotating from the stationary plates—were minimized. In this work the Bureau of Standards took the lead, developing, in 1915, a practically resistanceless condenser, using supports of quartz properly placed.

No one would purposely put a resistance of a hundred ohms or so, in the tuned circuit of a receiver, yet the resistance of the condenser you are using may be even higher. Some people say, "I don't see how a condenser can have resistance," but, as a matter of fact, condensers do behave just as if there were a resistance in series with the capacity.

At the present time, it is fairly well known that low resistance receiving condensers aid in securing maximum signal strength and sharpness of tuning. Few manufacturers, however, are making use of this knowledge.

The first commercial low-loss laboratory condensers available for general use were manufactured by the General Radio Co., in the latter part of 1915, and since that date the company has devoted a large amount of time to the development and manufacture of such condensers.

HOW TO JUDGE CONDENSER DESIGN

Before purchasing a variable condenser for use in a receiving set, examine first its mechanical construction, then look for electrical faults. Are the bearings smooth-running? Is the end thrust properly cared for? What about the assembly as a whole? Are the plates rugged, accurately spaced and rigidly clamped? Are the rotary plates locked together and

firmly secured to the shaft? Is a counterweight provided, for the panel mounting types? Is the dial true-running and easily read?

The mechanical properties can readily be observed, but unfortunately the electrical properties can be determined only by accurate laboratory measurements. However, the kind of insulating material and its location should be noted. Good insulating materials are quartz, porcelain and hard rubber; bakelite is fair, and fibre poor. The insulating material should be placed where the electrostatic field is weak, therefore, beware of variable condensers having small insulating bushings between metal parts which are at different potentials; for instance, at

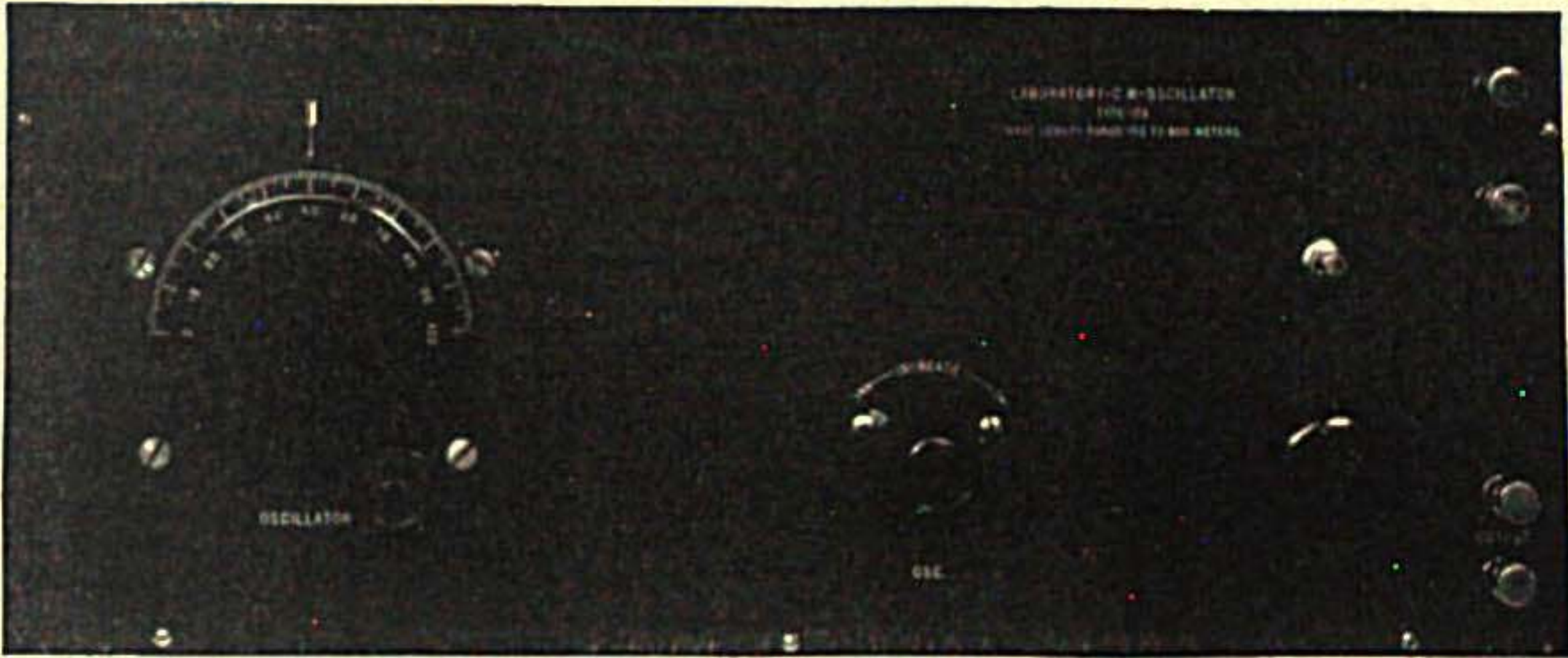

Fig. 171

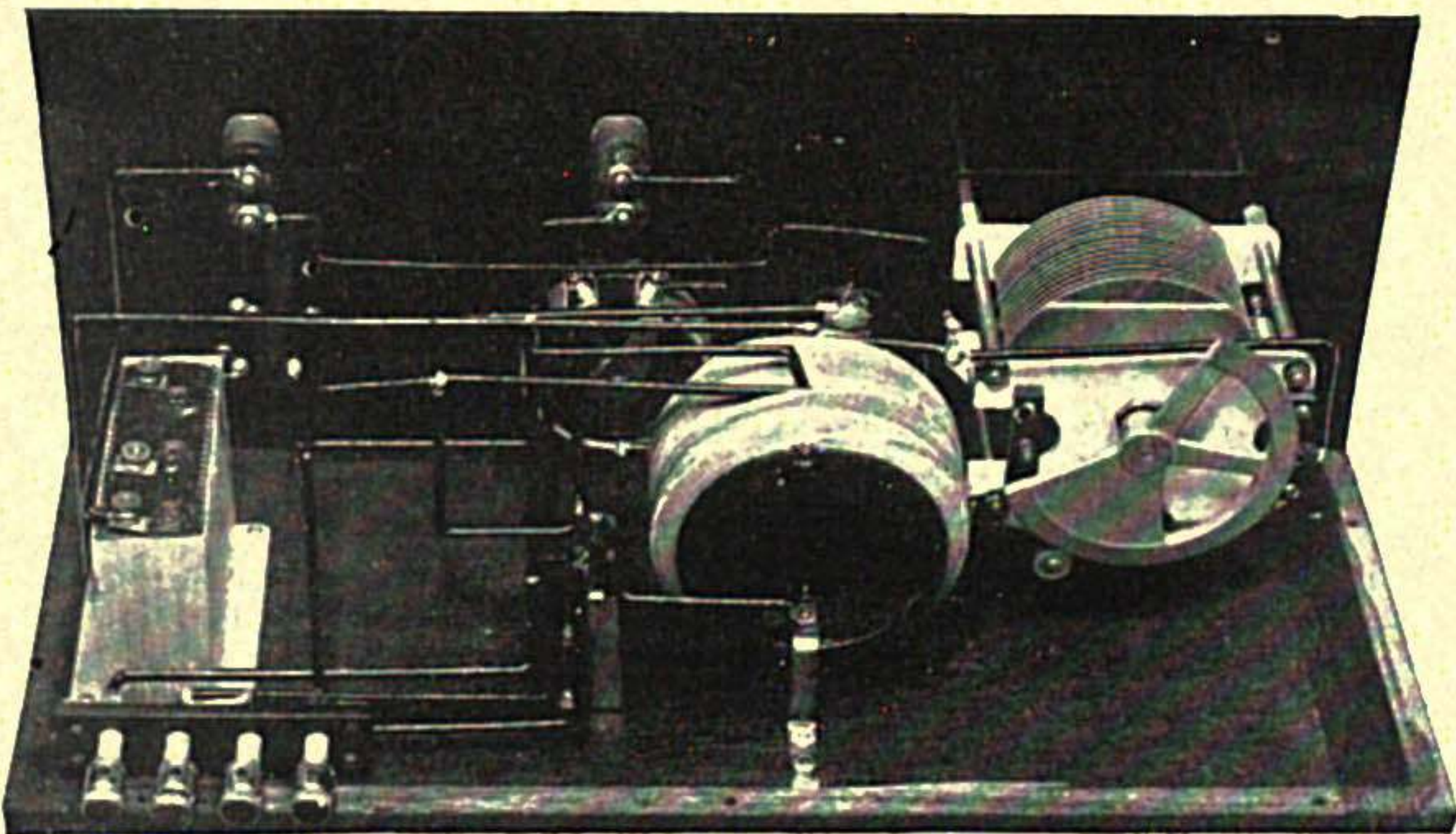

Fig. 172

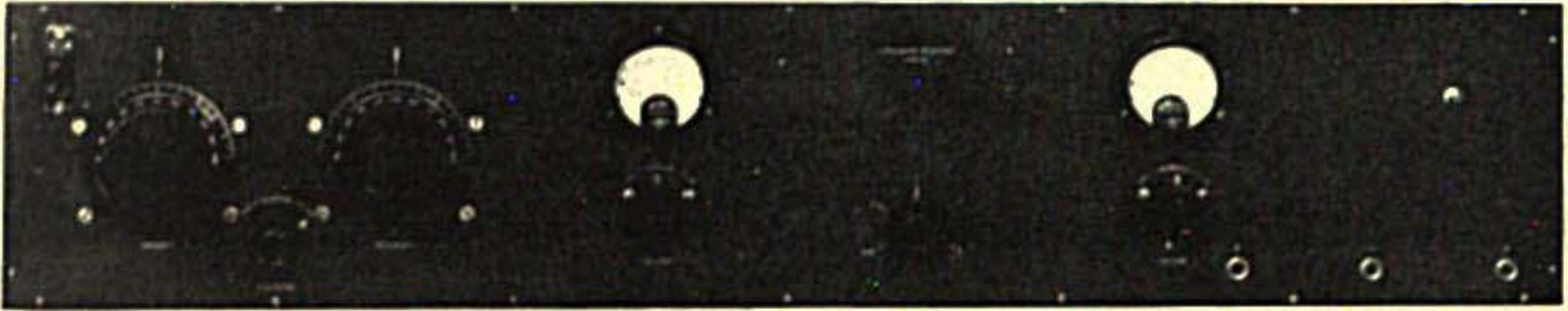

Fig. 173

Long Wave Receiver, Type 722.

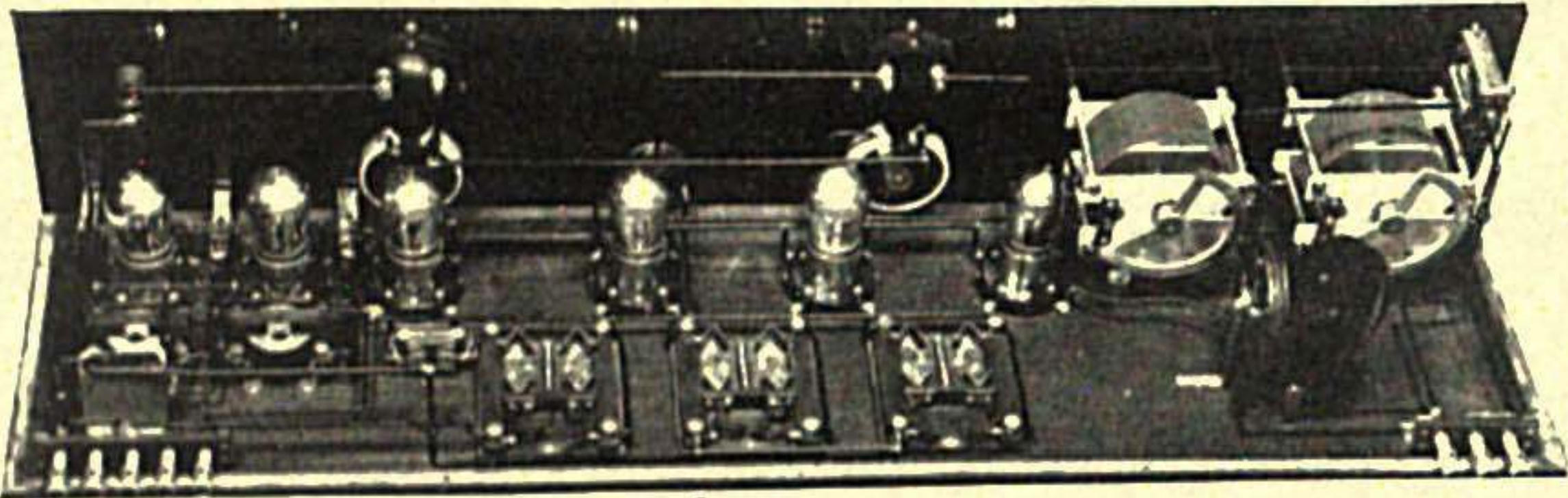

Fig. 174

Long Wave Receiver, Type 722.

the bearings, and in places where an extra vernier plate is insulated from the main shaft. Notice how the electrical contact is made with the moving plates; either a flexible conductor or a positive pressure contact should be used.

TYPE 247 VARIABLE AIR CONDENSERS

Quality condensers, at a reasonable price, are made possible by the General Radio Company's years of experience in building condensers used as laboratory standards. The careful design of Type 247, provides not only for low dielectric losses, but for a rigid mechanical assembly with a special type of spring bearing which supplies the correct amount of friction, compensates for wear, and assures positive electrical contact with the moving plates. All the thrust is on the upper bearing, which is so arranged that there can be no change of capacity, nor short-circuiting, if the distance between bearings becomes changed. The plates, of heavy brass sheet, are soldered together and to the shaft and supports, thus increasing the rigidity and lowering plate resistance.

As shown in the cut, Fig. 183, the condenser is fitted with reduction gearing and a small knob for fine capacity adjustment required in tuning to continuous wave stations. This is much more satisfactory and reliable than the usual complicated types of vernier.



Fig. 176
Laboratory Detector Unit
Size 8" x 8" x 8"

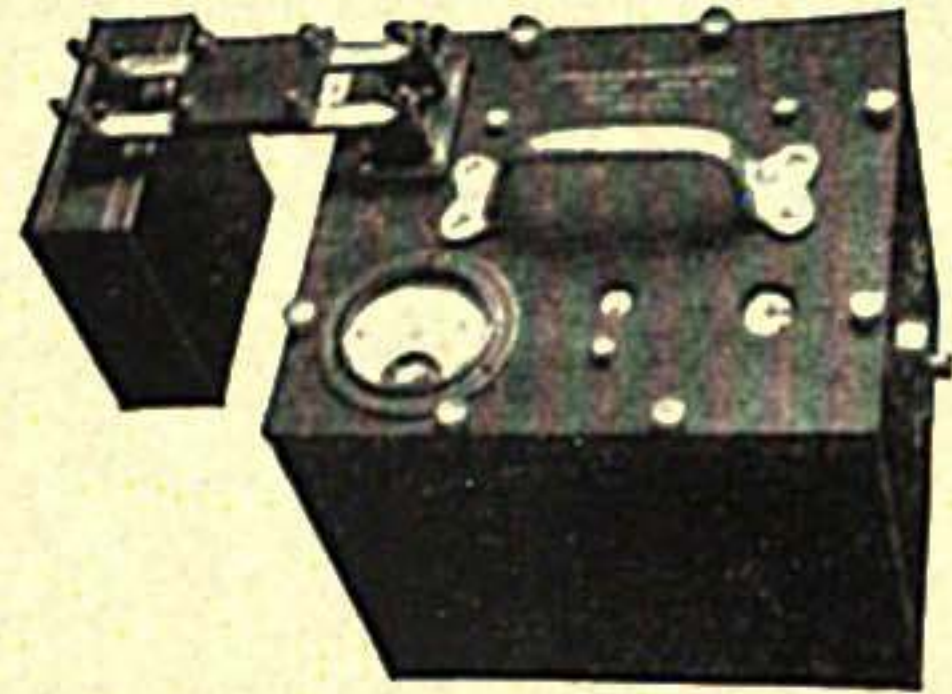

Fig. 177
General Radio Type 224 Precision Wave Meter

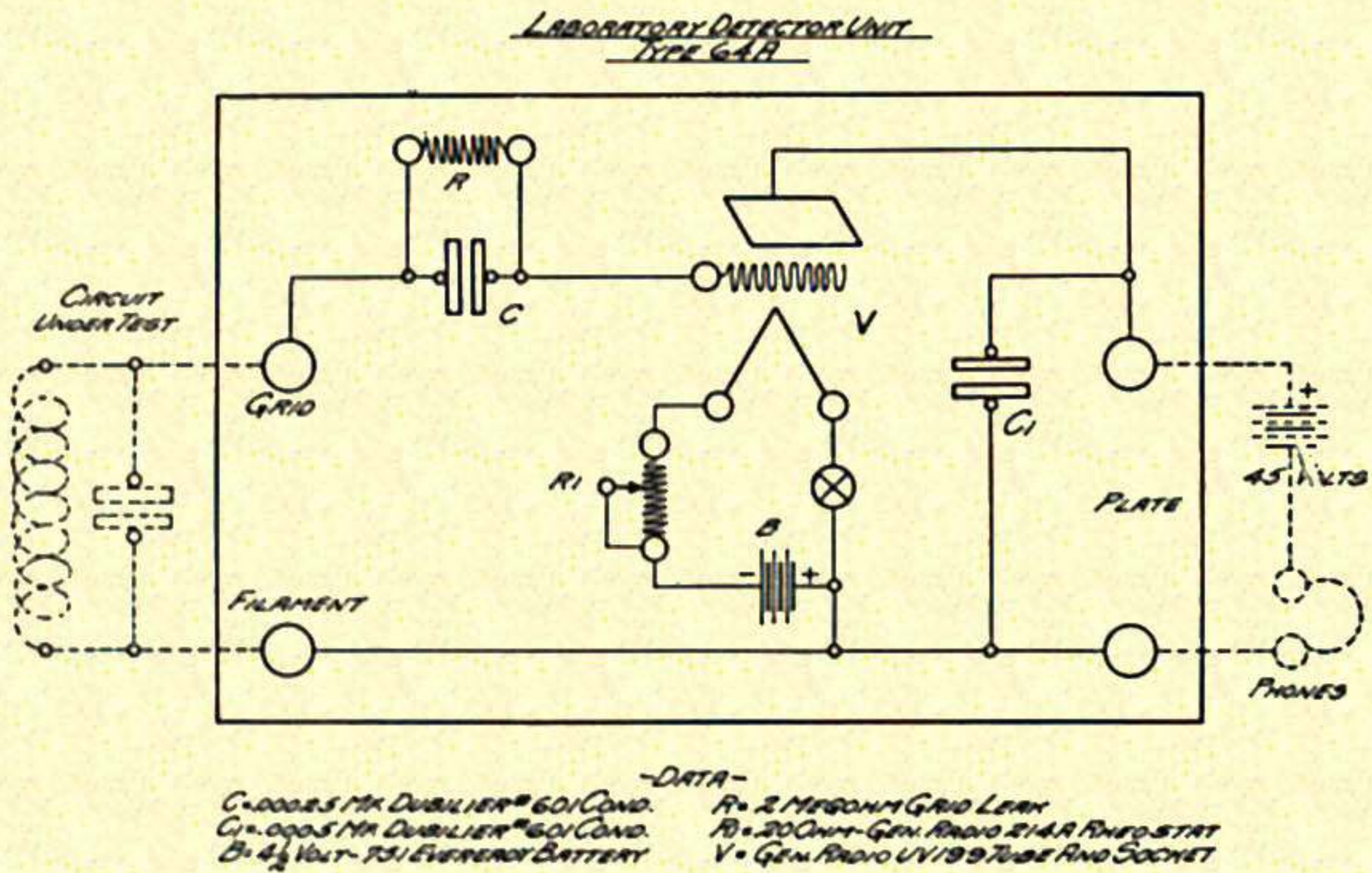

Fig. 178

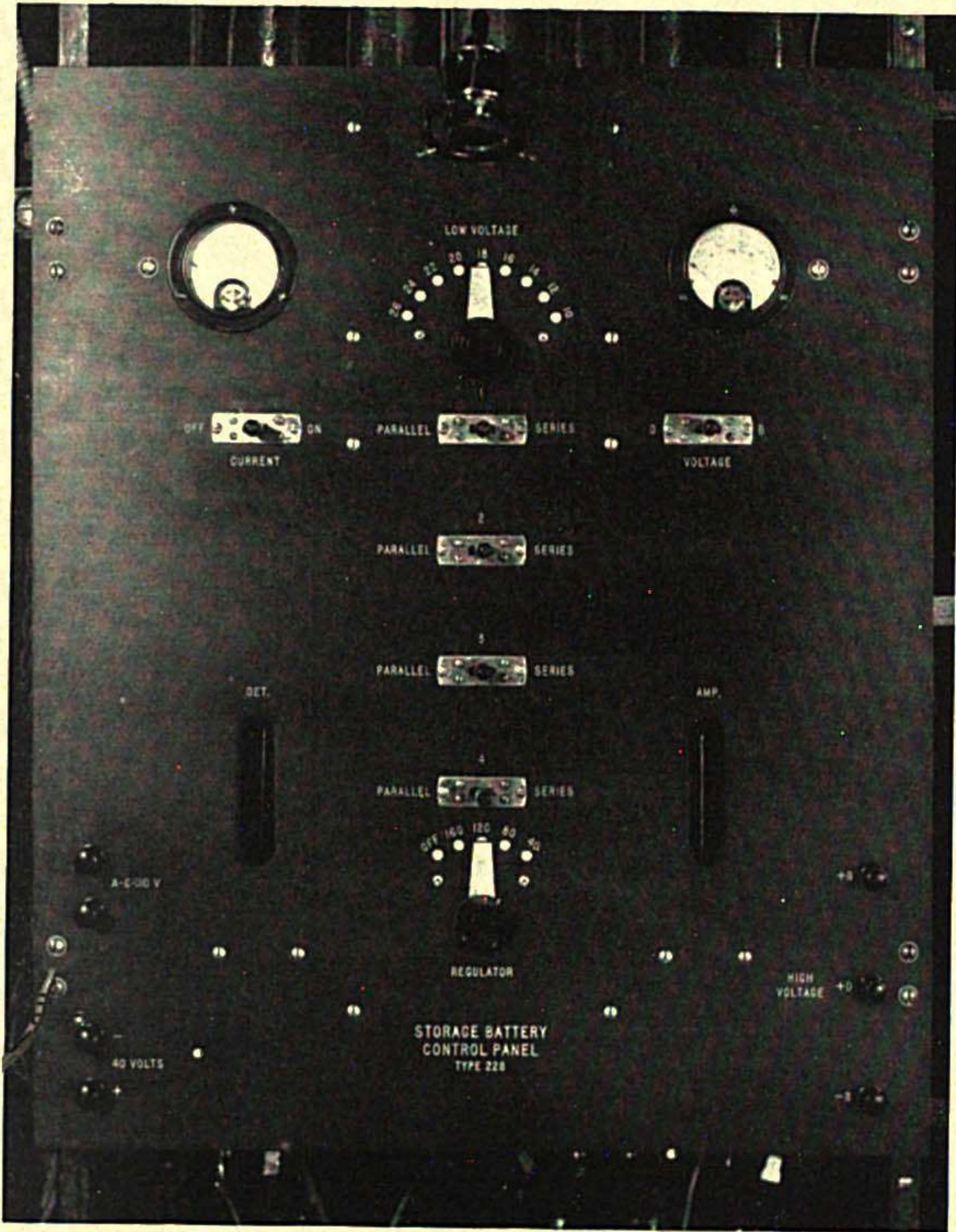

Fig. 179
Control Panel for Willard Storage B Batteries

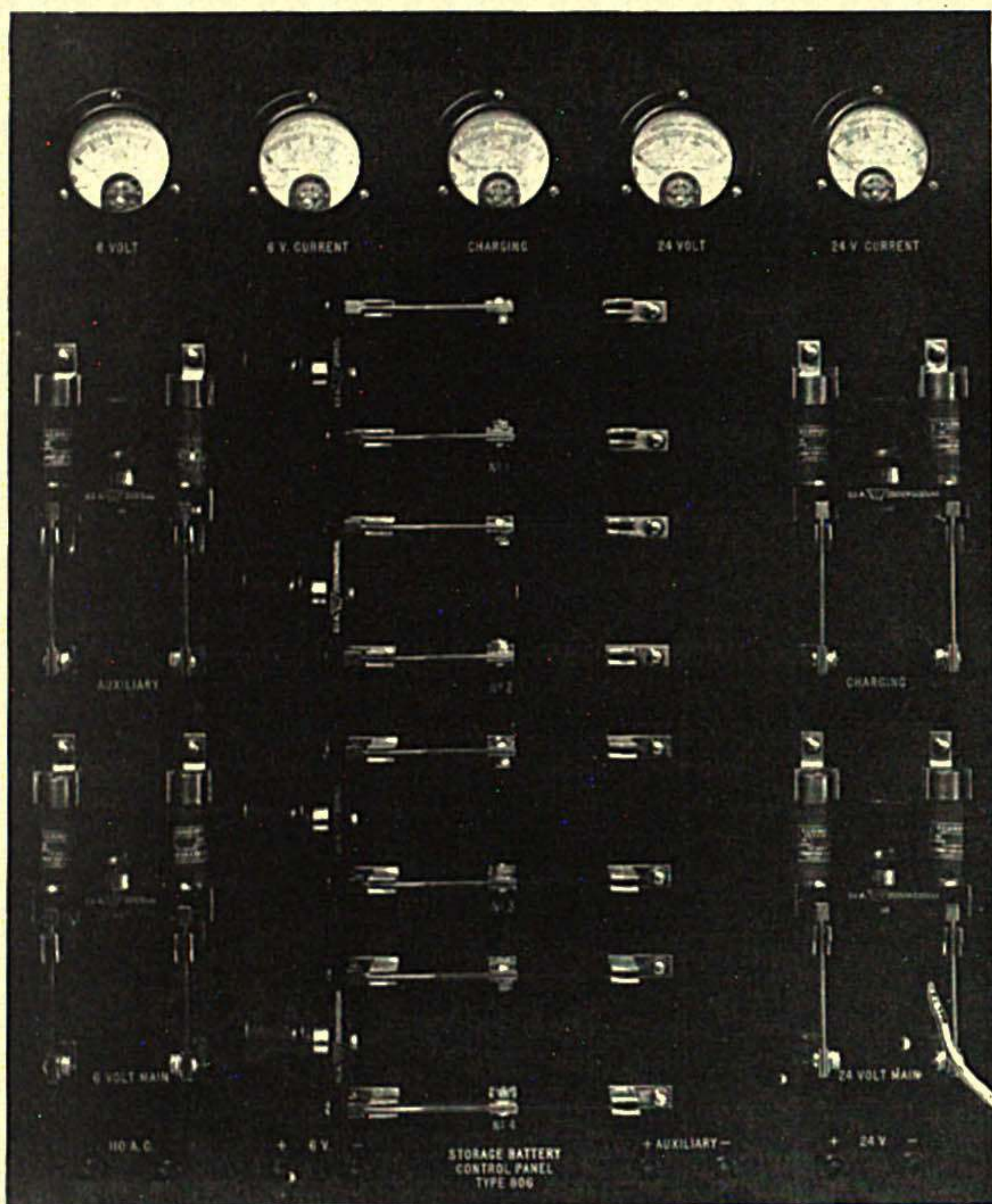
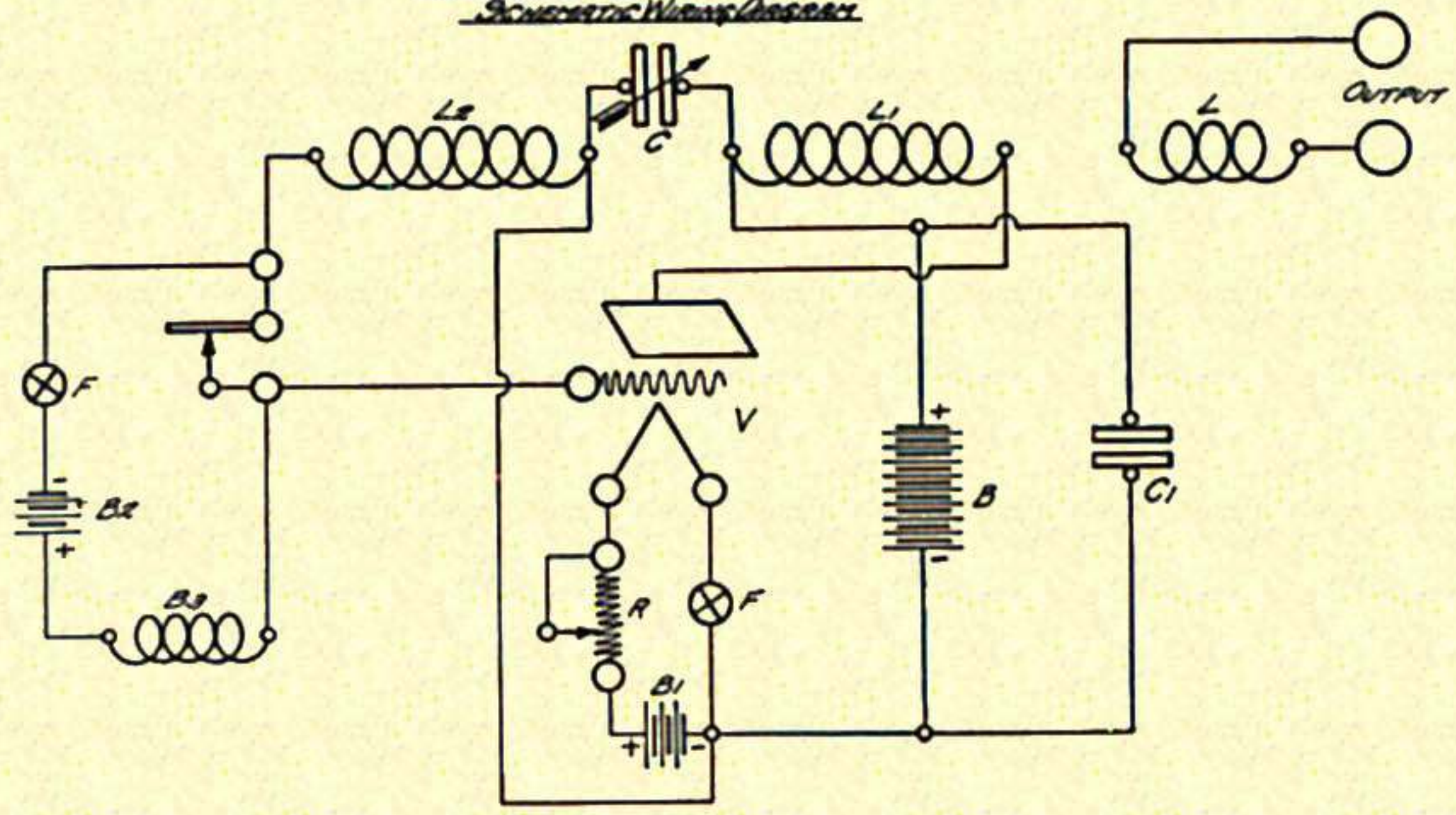

Fig. 180
Control Panel for Storage A Batteries

LABORATORY CW OSCILLATOR
TYPE 186 1600-600 METERS
SCHEMATIC WIRING DIAGRAM



- DATA-
- C = .001 MF GEN. RADIO #239 SPEC. COND.
 - C1 = 1 MF WESTERN ELECTRIC 21K COND.
 - B = 45 VOLT - EVEREADY 767 BATTERY
 - B1 = 4 1/2 VOLT - EVEREADY 751 BATTERY
 - B2 = 4 1/2 VOLT - EVEREADY 751 BATTERY
 - B3 = CENTURY BUZZER
 - F = CUTLER HAMMER FILAMENT SWITCH
 - R = 20 OHM - GEN. RADIO 214A RHEOSTAT
 - V = UV159 RADIOTRON AND SOCKET
 - L, L1, L2 = OSCILLATOR COUPLER

Fig. 181

LABORATORY CW OSCILLATOR
LONG WAVE - TYPE #25

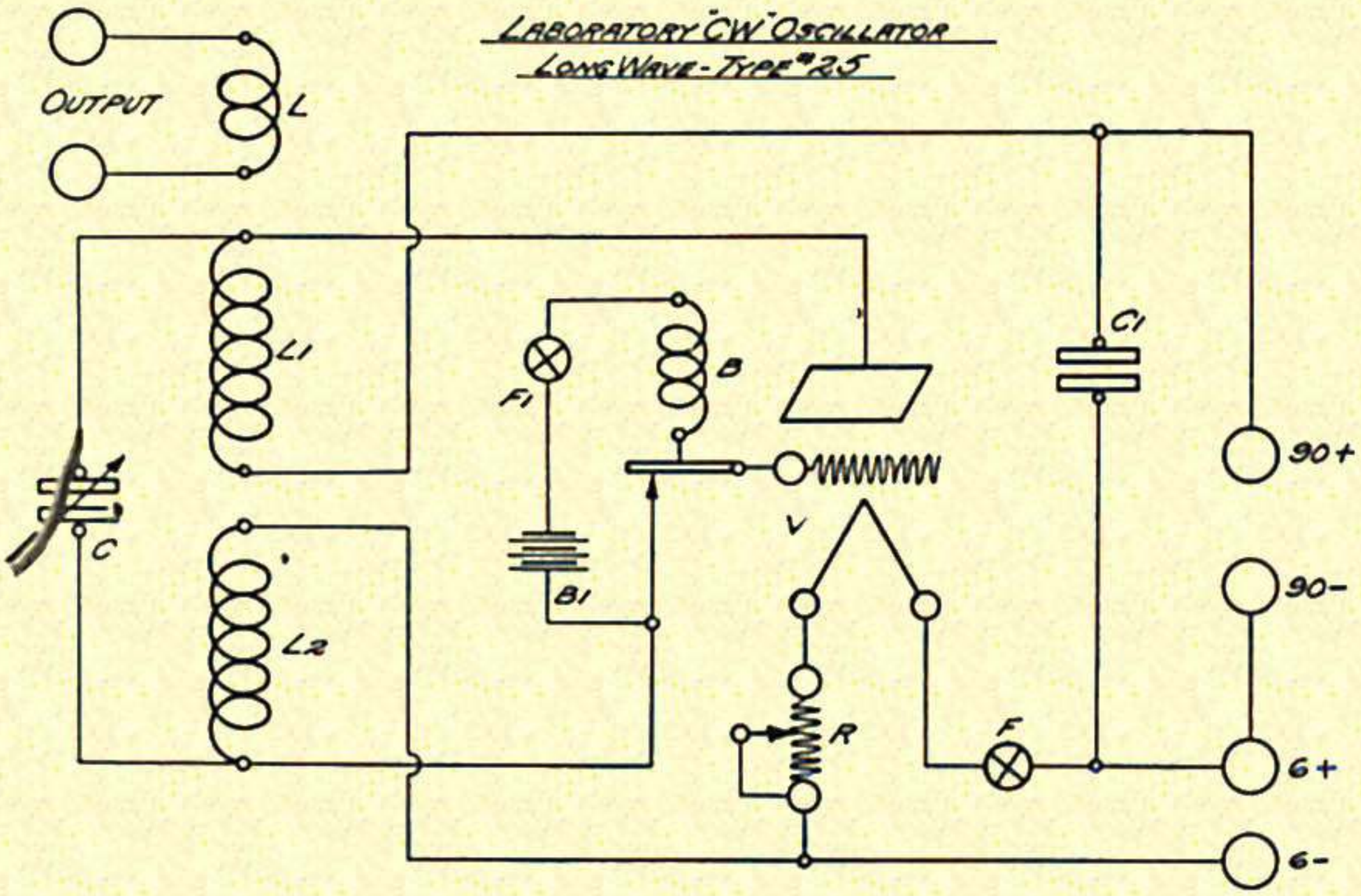

- DATA-
- C = .001 MF GEN. RADIO #239 SPEC. CONDENSER
 - C1 = 1 MF WESTERN ELECTRIC 21K CONDENSER
 - B = CENTURY BUZZER
 - B1 = 4 1/2 VOLT - 751 EVEREADY BATTERY
 - F = CUTLER HAMMER FILAMENT SWITCH
 - F1 = CUTLER HAMMER BUZZER SWITCH
 - R = 20 OHM GEN. RADIO 214A RHEOSTAT
 - V = GEN. RADIO 156 SOCKET - V.E. 216 TUBE
 - L, L1, L2 = OSCILLATOR COUPLER

Fig. 182

The zero capacity is low, 25 MMF. mounted, and 15 MMF. unmounted, making a wide range of wave lengths possible. The mounted condenser is enclosed in a metal case, which being grounded to the rotor plates, acts as a shield. These condensers are equipped with an etched metal dial, showing, in addition to the usual graduations, the capacity in micromicrofarads at any setting. The absolutely uniform spacing that results from our method of assembling the plates in a jig, makes it possible to fit such a dial, so that the accuracy of calibration is about 2%. The end-plates are of a high-grade hard rubber and so placed as to keep dielectric losses low.

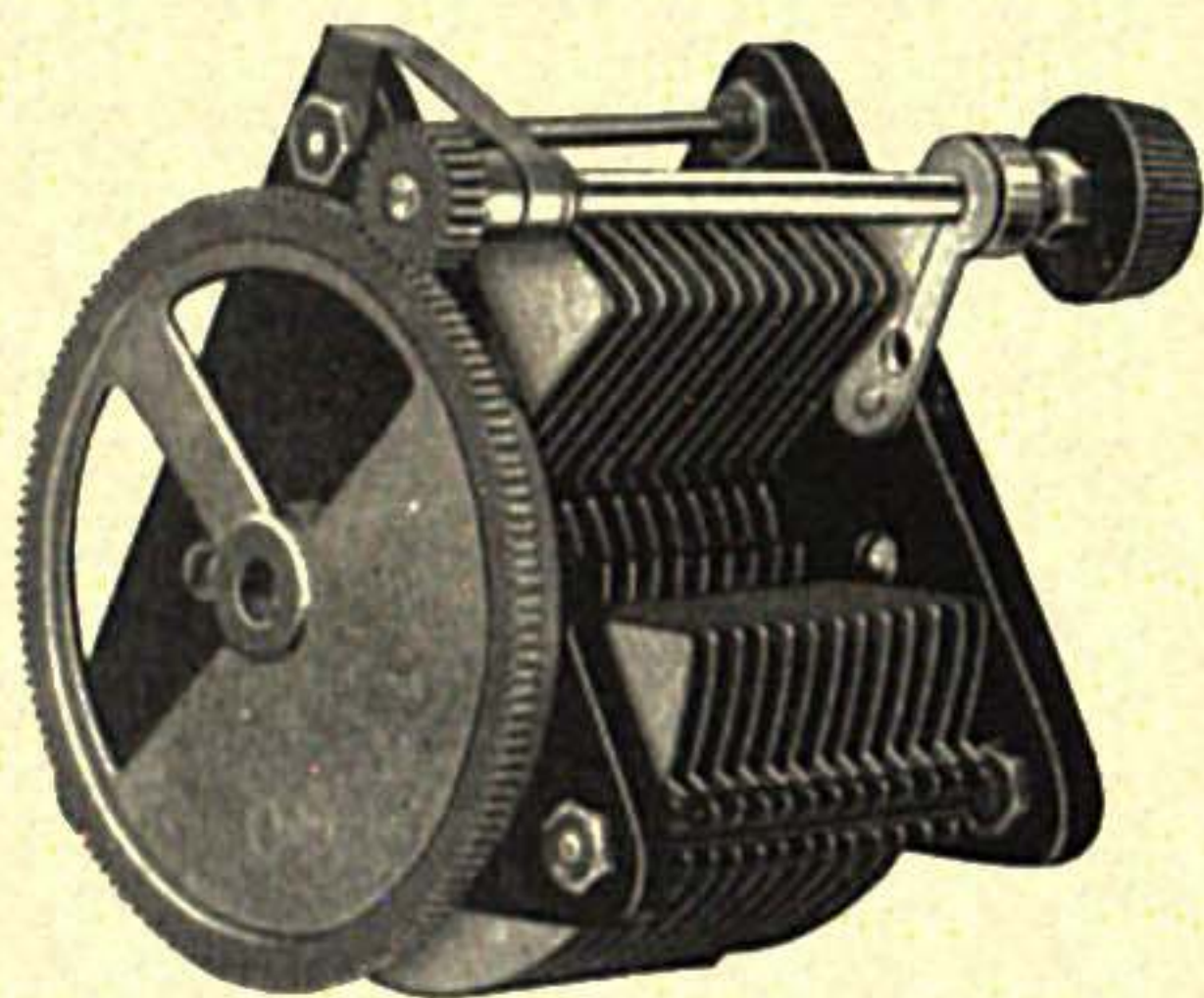

Fig. 183

General Radio Type 247-H Variable Air Condenser.

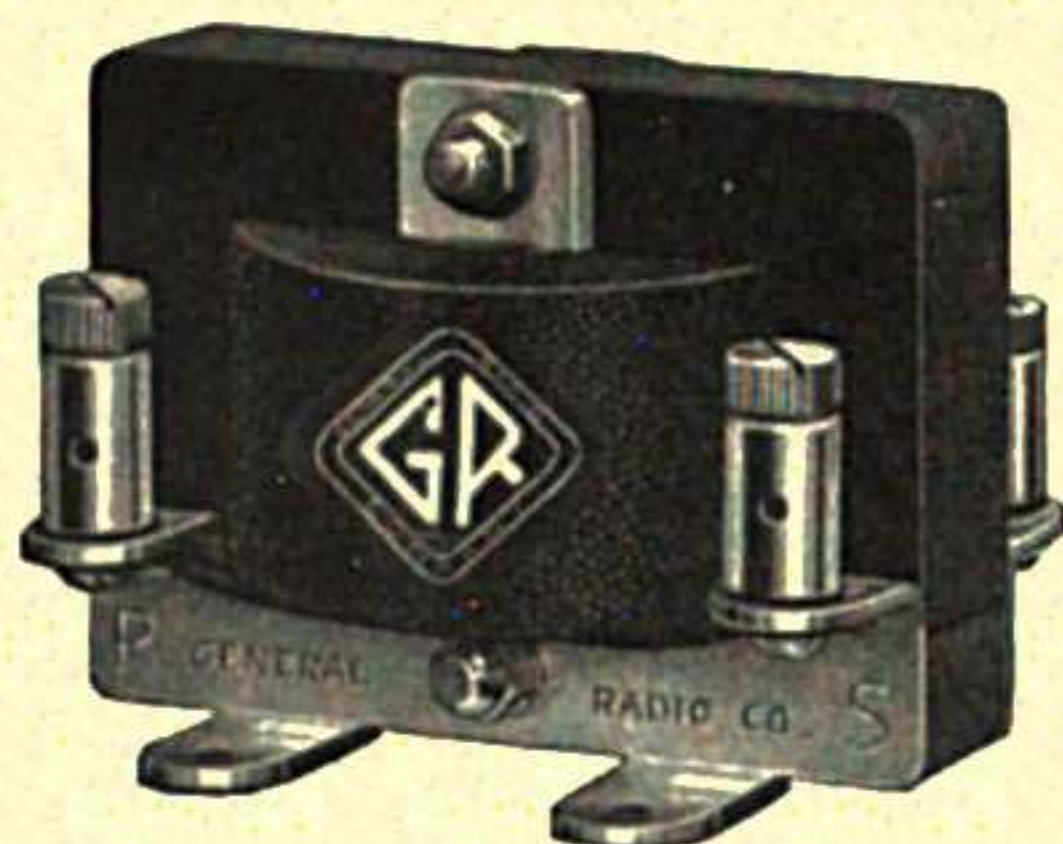

Fig. 184

General Radio Type 231-A Audio Transformer.

The measured losses in a representative Type 247 Condenser are as follows:—at maximum capacity, 1,000 MMF., the power factor is about .015%; the resistance at 1,000 cycles is 25 ohms, and at 834,000 cycles (360 meters) it is .03 ohms. At minimum capacity, 25 MMF. the power factor is about .6%.

USES OF TYPE 247 CONDENSERS

Due to features mentioned above, this condenser will be found especially valuable in tuning low resistance antenna circuits, in a loop receiving circuit, in a wavemeter, in a radio filter, and as an experimenter's standard of capacity.

The 500 micromicrofarad size can be used as a series antenna condenser for low power C. W. transmitters (1,000 volts peak) and for single-circuit receivers. Since the slow-motion shaft is insulated, the capacity of the operator's hand does not interfere with tuning.

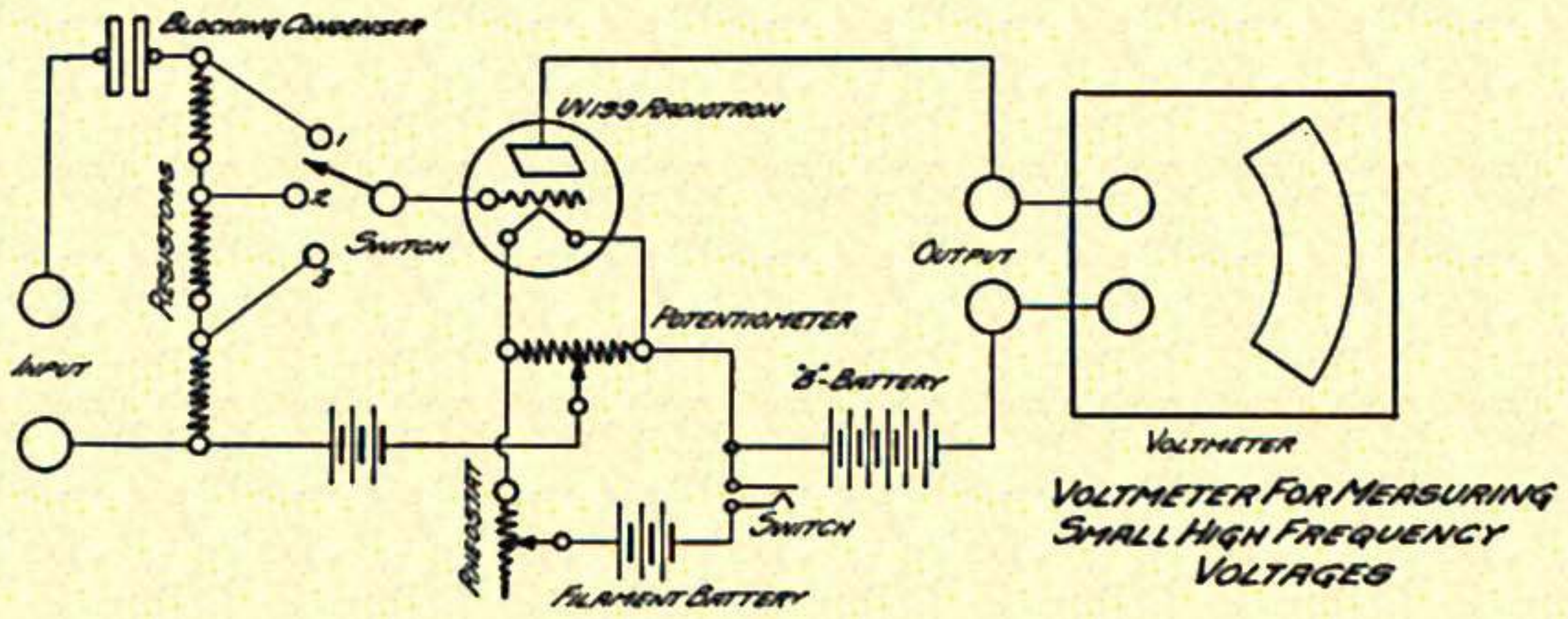

Fig. 185

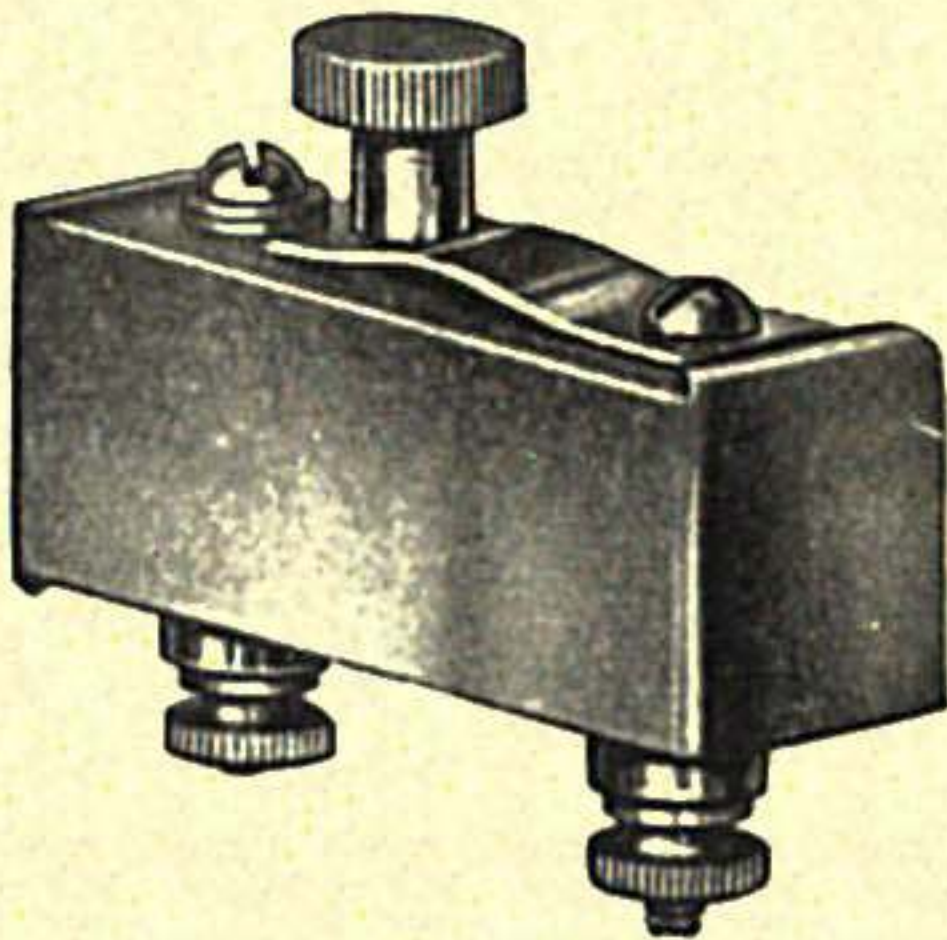

Fig. 186

General Radio Type 178 High Freq. Buzzer.

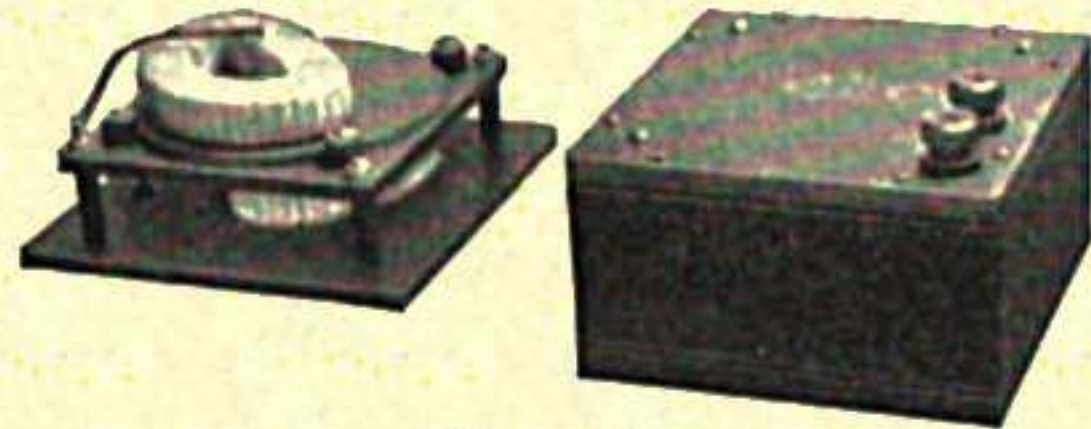

Fig. 187

General Radio Type 106 Standard of Inductance.

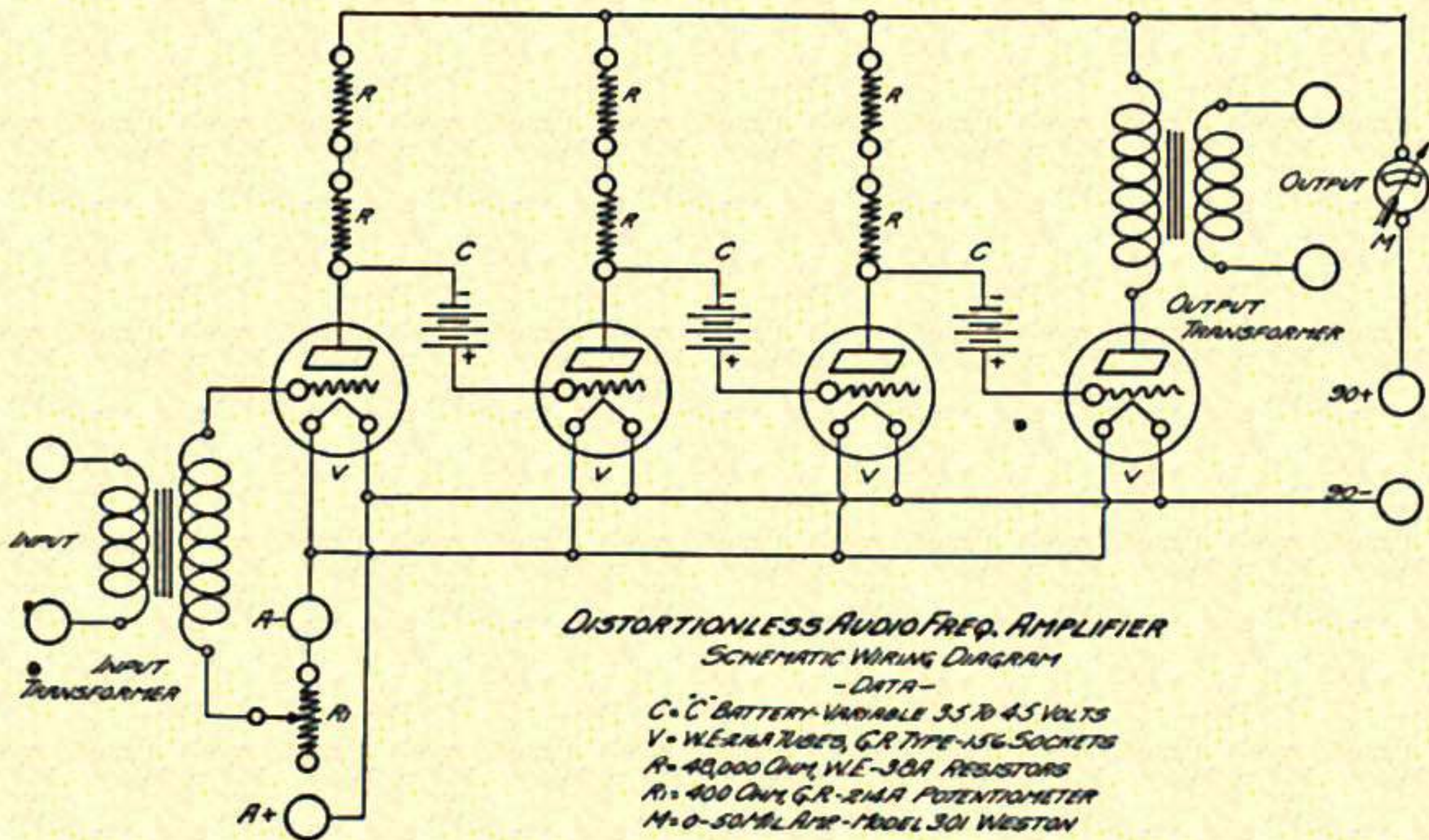

Fig. 188

AUDIO TRANSFORMERS

Transformers are used extensively in the entire electrical industry. They are found in the lighting service, signal work, and even in your house telephone installation. It is no wonder then, that they occupy such a prominent place in radio amplification.

De Forest's discovery of the value of adding a grid to the earlier forms of two element vacuum tubes opened entirely new possibilities for the use of tubes. Since the grid acts as a trigger, or more nearly a valve, controlling the current flow in the plate circuit, it at once became evident that tubes could be connected in cascade thus obtaining amplification at audio frequencies of the detected signals.

The first connecting device between the detector and amplifier tube was a simple open core impedance. This arrangement, although producing a voltage drop between the grid and filament to control the amplifier tube, gave only the amplification of the tube. The next step was to adjust the impedance by using two windings, a primary and secondary, so that the high impedance of the grid circuit would be adjusted to the lower impedance of the detector output circuit. This new instrument, known as an open core amplifying transformer, permitted the obtaining of a higher overall amplification factor.

It was considered inadvisable to use a closed core because of the belief that an all iron core would, under load, vary the transformer impedance and cause distortion of signals. The desire to use two or more tubes in cascade to increase the amplification, however, made it imperative that some change be considered. The open core transformers had such large external fields that if two transformers were placed near together, the interaction of these fields would cause serious howling.

A careful study of the actual operating conditions showed that a closed core transformer could be designed using suitable iron laminations, properly assembled, that would be free from distortion. This type of transformer was more compact, had a lower resistance for a given impedance, and had, of course, a very much smaller external field than the open core type.

The GENERAL RADIO COMPANY was the first company, to have available for the experimenter a closed core audio frequency amplifying transformer. This was before the United States entered the war. Many of these transformers were supplied to the army and navy during the war, and with the return of amateur radio after the war, thousands have been supplied for use in this country and abroad.

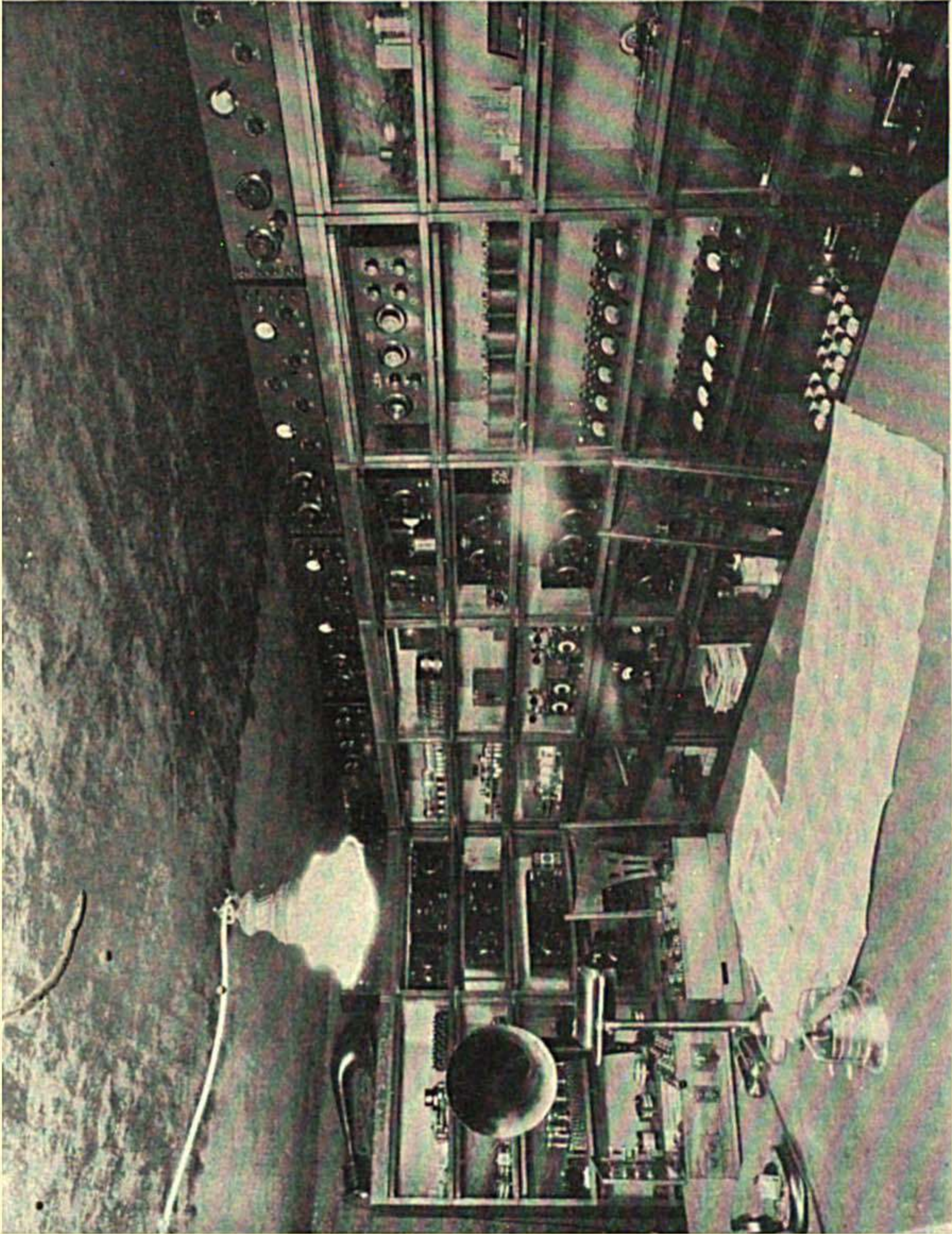

Fig. 189
Private Laboratory of C. R. Leutz.

The subject of amplification has received much attention in G. R. research laboratory. Improvements have been made from time to time until now the present model, the Type 231A, (Fig. 184) represents the best in amplifying transformer design.

OPERATION

The amplification of a set can be materially increased by the careful adjustment of the amplifier potentials. Since the amplifier tube operates on the principle of grid voltage control, the plate of the tube must be maintained positive in order that the electrons emitted by the filament will flow to the plate. The grid is maintained negative. When voltages over fifty are used on the plate, the grid becomes less effectively negative and current flows from the filament to the grid. This produces a voltage drop from grid to filament which reduces the voltage effective for amplification. In order that the grid may be maintained negative, a dry battery of from 2 to 10 volts should be connected in the lead connecting the inside of the transformer secondary to the filament battery. The negative side of the biasing battery should be connected to the transformer and the positive side to the negative terminal of the filament battery. Where plate voltages only of the order of fifty are used, a "C" or grid biasing battery is not necessary.

TYPE 239—VARIABLE AIR CONDENSER

The recent studies of dielectric losses have brought out forcibly the necessity for giving much attention to these losses in condenser design. Their importance has been further emphasized by the requirements of vacuum tube oscillating circuits. Such circuits demand for sharp resonance that these losses be kept a minimum. Condensers which might be adequate for crystal receiver circuits would be quite unsatisfactory for use in vacuum tube oscillating circuits.

Where great precision is required, there is available G. R. Type 222 precision condenser. Because of its necessarily elaborate design, however, it is not suitable for installation in radio sets or for general laboratory use. It is a precision standard. In order to have available a condenser which would meet the general laboratory requirements and the rigid requirements of carefully designed radio sets, G. R. have developed the rugged, low-loss condenser shown in the cut (Fig. 190). This condenser is similar in general design to their precision condenser. It has metal end plates, locked cone bearings and is rigidly supported. The only solid dielectric material used is in the form of supporting strips for the fixed plates. These strips are of carefully selected hard rubber, and are placed



Fig. 190
General Radio Type 239 Variable Air
Condenser.

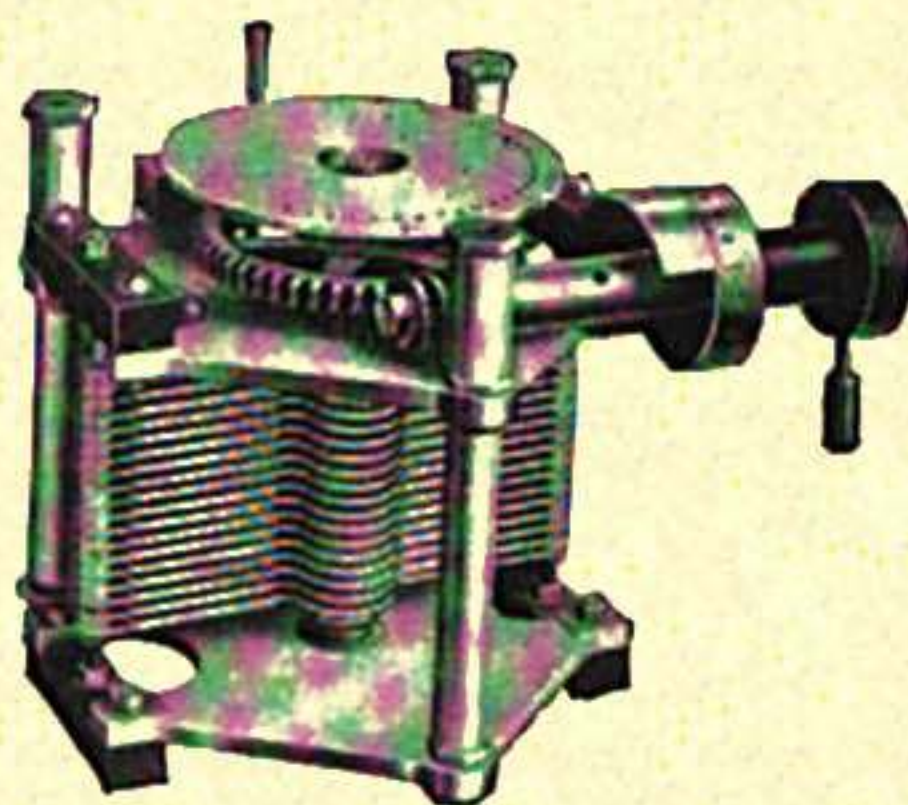

Fig. 191
General Radio Type 222 Precision
Condenser.

in a weak and uniform electrostatic field. This enables us to keep the losses at a minimum. The equivalent series resistance is but 12 ohms at a frequency of 1,000 cycles and a capacitance of 1,000 micromicrofarads. This is of the order of about a tenth of what is usually obtained in good variable air condensers. This very low loss enables oscillating circuits to be tuned very sharply. This condenser will stand potentials up to 800 volts.

The rotary plates are grounded in order that capacity effects of the hand when adjusting the condenser may be reduced to a minimum. The plates are of heavy aluminum and are so shaped as to give a nearly uniform wavelength variation. This is particularly important when the condensers are to be used in wavemeters or radio receiving sets.

All types of this condenser are provided with a counterweight and when so desired, may be equipped with a slow-motion gear so that settings to a fraction of a division on the scale may be obtained with ease. This is a distinct advantage when tuning to continuous wave stations.

When mounted, the condenser is provided with oak case and engraved bakelite panel. All condensers, whether mounted or unmounted, are equipped with a three-inch silvered dial divided into one hundred divisions.

TYPE 222—PRECISION CONDENSER

Condensers used as standards and for precision measurements must have many features not usually found in ordinary laboratory condensers. For variable standards it is essential that the plates be sufficiently rigid and well spaced so that handling the condenser will not cause a change in capacitance. It is not alone sufficient that the power factor be low,

but it is also important that the dielectric losses be substantially constant throughout the entire range of the condenser.

The General Radio Co. Type 222 Precision Condenser Fig. 191 is intended for those places where precision is essential, rather than for use as an ordinary laboratory experimental condenser. In its design, the mechanical as well as the electrical features have received special attention.

Mechanical—The plates are of heavy aluminum, widely separated by accurately turned spacers, and firmly clamped between substantial cast metal end-plates. A steel shaft, carrying the rotating plates, turns in cone-shaped bronze bearings. The adjustment is locked after the condenser has been subjected to a rotation test to insure the proper wearing in of the bearings.

The rotary plates are turned by a worm and gear, thus permitting fine control. The worm is held by spring tension in position against the gear to prevent backlash. This is the same method used in accurate dividing engines. The rotation mentioned above includes the worm and gear so that they are well worn into place before the condenser passes inspection.

Electrical—The stator plate assembly is insulated from the rigid end-plates, carrying the rotor assembly, by specially selected and treated porcelain blocks. As these blocks are small in volume, and placed in a weak, non-varying electrostatic field, the condenser has a very low power factor, .007% at 1,000 MMF.

When using this condenser in measuring the power factor of absorbing condensers, the fact that the field, where the porcelain supports are located, does not vary with condenser setting, is of importance, because it permits the assumption that the precision condenser is the equivalent of two condensers in parallel, one being a perfect condenser of variable capacity, the other a small fixed condenser with which is associated all the dielectric losses.

The temperature coefficient of this condenser is practically nil, and there is no change in capacity with frequency. The equivalent series resistance at 1,000 cycles and 1,000 MMF. is approximately 11 ohms. The breakdown potential is about 1,000 volts.

TYPE 231A AMPLIFYING TRANSFORMER

The Type 231A, Fig. 184, Amplifying Transformer is designed to give the maximum of amplification possible without distortion. It is the result of careful engineering design.

The windings are of No. 40 copper wire, carefully layer wound, thus

reducing the tendency to open circuit, as is common with transformers using finer windings. This tendency to open is the most serious defect in amplifying transformers. In the Type 231A Amplifying Transformer it is carefully guarded against during construction and every transformer is connected in a testing circuit before shipment. Every transformer is guaranteed and will be replaced if winding defects ever develop. The layer winding with its insulation and impregnation prevents short circuited turns. Selected electrical sheets are used for the core.

The lead from the outside of the amplifying transformer secondary to the grid of the tube should be kept as short as possible and away from other wires, particularly those of the plate circuit. By so doing the tendency to howl will be greatly minimized. When two or more

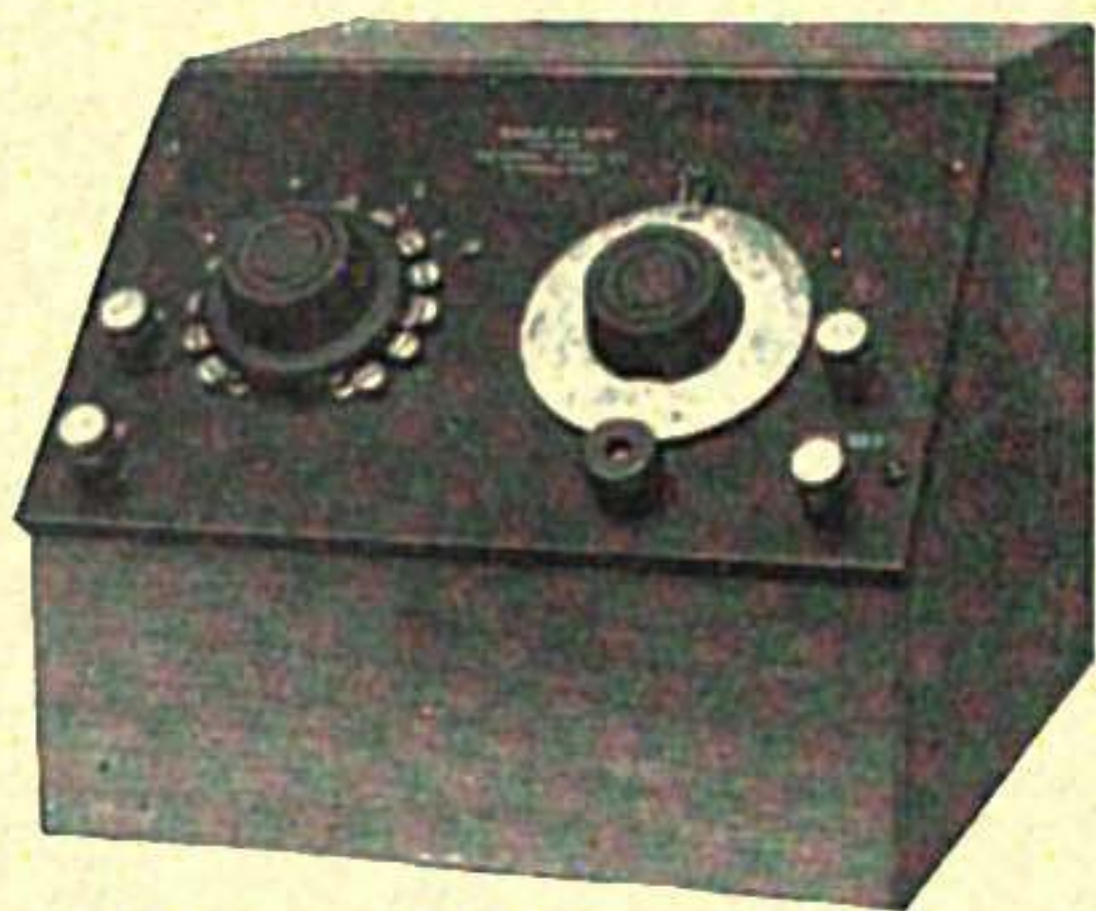

Fig. 192. General Radio Type 305 Combination Wave Meter and Filter



Fig. 193. General Radio Type 164 Audibility Meter

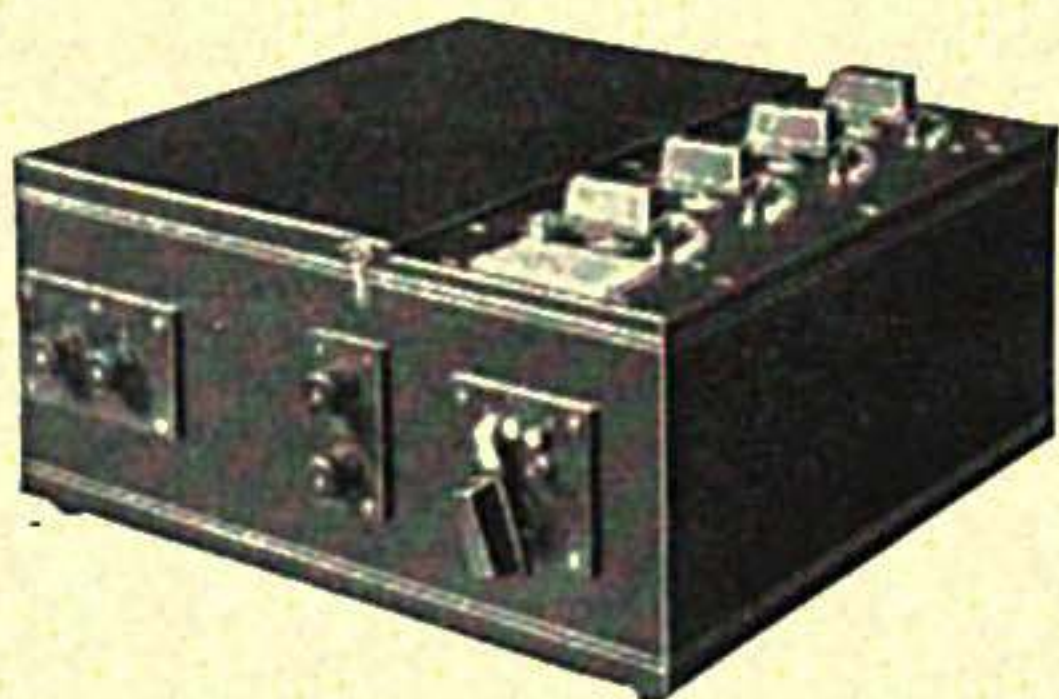

Fig. 194. General Radio Type 216 Capacity Bridge



Fig. 195. General Radio Type 229 Universal Galvanometer Shunt

transformers are used for multi-stage amplification, it is best to place them at right angles so as to reduce interaction between their fields.

The use of a grid leak of about one megohm connected between the grid and the negative filament terminal will improve the quality of received telephone signals. This is particularly true with high pitched notes. The leak also adds desirable damping to the circuit, thus further tending to prevent howling.

A properly designed transformer does not have a resonance point in the audio frequency range. It is only in the case of transformers having such resonance points that transformers having different ratios should be used in multi-stage amplification. Use the Type 231A for all stages.

The electrical constants of the windings are as follows:

	Primary	Secondary
Direct current resistance, ohms.....	1,100	5,500
A. C. resistance at 1,000 cycles, ohms.....	11,000	130,000
Reactance at 1,000 cycles, ohms.....	50,000	600,000
Winding Ratio	1 to 3.7	

PRECISION WAVEMETER

Range 75-24,000 meters (4,000-12.5 kilocycles)

This wavemeter is designed to provide an accurate instrument for laboratory service, yet sufficiently portable for general measurement work where precision is essential.

Mechanical—Since the condenser is the Type 222, Fig. 19', it is not necessary to repeat its description here. The coil mounting is rugged, and particular care has been taken to lock or pin all parts to keep them secure. The coils are wound and mounted in such a manner that the turns cannot become loose.

Electrical—A standard wavemeter must have low decrement giving sharp tuning. This has been accomplished in the Type 224 wavemeter (Fig. 177) by the use of a low loss condenser and by winding the inductances with stranded cable. In the design of these inductances, of which there are five, attention also has been given to the necessity for low dielectric losses, low distributed capacity, good form factor, and a reasonable amount of overlap in wave length.

To insure accuracy under all conditions no extra circuits such as a buzzer or detector are incorporated in the wavemeter. There is but one

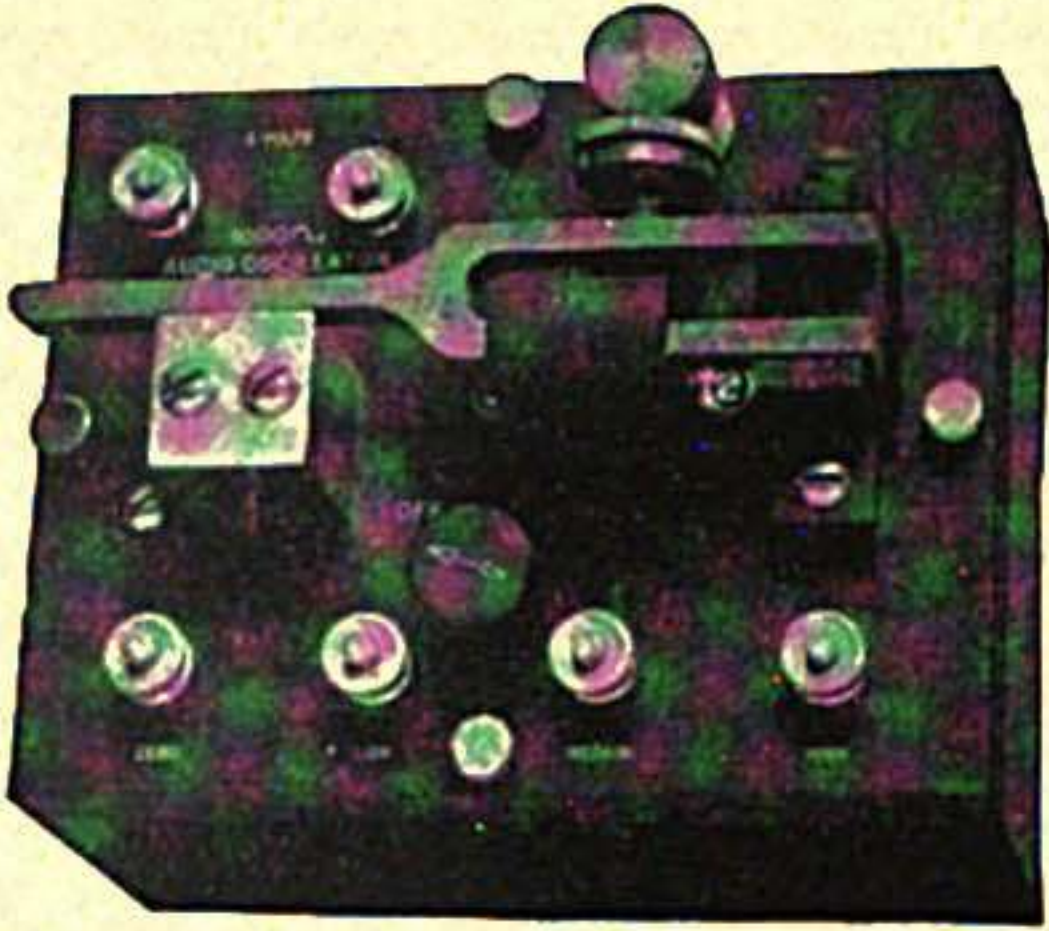

Fig. 196. General Radio Type 213
1,000 Cycle Audio Oscillator



Fig. 197. General Radio Type 193
Decade Bridge

circuit, the calibrated oscillating circuit, which consists of the condenser, an inductance and a Weston thermo galvanometer for indicating resonance. This circuit is so connected that the condenser rotor plates, the condenser shield, the thermo galvanometer and the outside of the inductance coil are at low potential. This prevents disturbances due to variation in stray capacities.

Scales and Calibration—The scale arrangement is the same as is used on the Precision Condenser. Mounted calibration curves are furnished for each coil. The standards used in calibrating are checked by the U. S. Bureau of Standards, and also checked in the G. R. laboratory by stepping up frequencies of standard tuning forks by the harmonic method. A capacity calibration chart for 26 points on the condenser is also furnished. When making measurements of continuous wave, it is possible to determine the resonance point to $\frac{1}{2}$ division of the sub-scale, thus giving an accuracy of 1 part in 10,000. The absolute values of frequency are accurate to .25 per cent.

Mounting—The condenser is mounted in a polished walnut case similar to that of the Precision Condenser. Each inductance coil is enclosed in a walnut box with an engraved hard rubber panel stating the wavelength range. The terminal blocks are so shaped that they will fit on to the connecting bars in one way only, thus insuring that each coil will always be connected in the same manner in which it was calibrated.

A strongly built whitewood shipping case is furnished with each wavemeter. Separate compartments are provided for the condenser and coils. This case is fitted with a carrying handle and lock.

STANDARDS OF RESISTANCE AND DECADE RESISTANCE BOXES

The ideal standard of resistance for alternating current measurements, and particularly for those at radio frequencies, is one which has zero change of resistance with age, changes of temperature or frequency, and which has a zero phase angle for all frequencies. By selecting carefully the material on which the resistance coil is wound, the kind of wire used, and taking care that in soldering the terminals the connections are permanent and free from corrosion, there will be no appreciable change in resistance with age. As there are several alloys now available whose temperature co-efficient is very small and is constant over a wide range, it is a simple matter to determine with high accuracy the change of resistance of a coil for any ordinary working temperature. To obtain zero change of resistance with frequency and to obtain 100% power factor is a much more difficult proposition. A change in resistance with frequency is due largely to skin effect and to the distributed capacitance of the coil. The phase angle change with frequency depends only on the inductance and capacitance.

Several methods have been used to reduce the inductance and distributed capacitance of resistance units. The Ayrton-Perry method used in G. R. coils is not only satisfactory electrically, but also mechanically. The winding is placed on a thin bakelite form. A single wire is first wound on with a space left between turns equal to the diameter of the wire. A second wire, connected so as to be in parallel with the first, is then wound on the form in the spaces between the turns of the first wire. The direction of rotation of the second winding is opposite from that of the first, thus making two crossings with the first wire in each complete turn. This arrangement keeps the currents in the two wires flowing in opposite directions and at the same time keeps adjacent wires at nearly equal potentials. This type of winding has the lowest distributed capacitance and inductance of any of the commercially used windings.

The current carrying capacity of the one-tenth ohm units is one ampere, that of the one ohm units one-quarter ampere, that of the ten ohm units one-tenth ampere, and that of the one hundred ohm and one thousand ohm units five-hundredths ampere. The accuracy of these coils above one ohm is .1% on direct current and about .5% at 1,500,000 cycles (200 meter wave length). The wire used has a practically nil temperature co-efficient of resistance and contains no iron. These resistance units are furnished in two styles of mountings, as single unit standards of resistance and as decade resistance boxes.

DECADE RESISTANCE BOXES

For general laboratory use the most convenient resistance arrangement is that of decade units. By such a method it is possible to get nearly any value of resistance desired. Such units are compact and rugged. With the use of multiple-leaf contact brushes with each leaf making independent contact, and with the ends of these brushes so cut that they are not tangent to the path of travel, thereby preventing the cutting of grooves in the contact studs, the dial method of mounting decade resistance units is fast replacing the older and less satisfactory plug method of connection. This newer method eliminates the inconvenience of the shifting of plugs, and also their possible loss.

The General Radio Co. Type 102 (Fig. 207) decade units are mounted on bakelite panels with engraved lettering, and are enclosed in oak boxes. The exposed metal parts are finished in polished nickel.

Attention is called to the fact that each decade dial has eleven contact studs, a zero and ten steps. This feature is especially important when working at the upper or lower ends of a dial.

These decade boxes are made in three general types, two, three and four dials. These general types, however, may cover different ranges.

RATIO ARM BOX

For many laboratory measurements such as Wheatstone bridge or impedance bridge measurements, when a complete bridge is not available, it is very convenient to have mounted in one unit, suitable resistances which may be used as ratio arms. Such an arrangement is also convenient for comparing capacitances, without the use of a compensating resistance, where errors of the order of one or two per cent are permissible.

The type 210 Ratio Arm Box (Fig. 199) consists of two similar arms, each with 1,000 ohms, total resistance, and with intermediate taps at 1-3-10-30-100-300 ohms. The resistances are the Ayrton-Perry type, described on Page 240. They are non-inductive and have very low distributed capacitance. The current carrying capacity is five-hundredths of an ampere. The accuracy of adjustment is .01%. These resistance units are mounted in a polished oak box fitted with an engraved bakelite panel. The dial switches are the standard bridge type and have a low and constant resistance.

UNIVERSAL GALVANOMETER SHUNT

When indicating a bridge balance by means of a galvanometer, it is desirable to have a shunt for protecting the galvanometer during the

preliminary adjustments. A calibrated shunt is also desirable for extending galvanometer ranges when used for the measurement of small currents. The most convenient type of a galvanometer shunt for general laboratory use is the Ayrton-Mather Universal type. The relative multiplying factors of this shunt remain constant for any resistance galvanometer.

G. R. Type 229 Galvanometer Shunt (Fig. 202) is arranged in accordance with the Ayrton-Mather principle and has a total resistance of 1,000 ohms. Taps are arranged to permit a reduction of the galvanometer current to .001-.01-.1 of the maximum. A short circuit point is also provided to give complete protection to the galvanometer when so desired. The control is by means of a standard bridge type of dial switch.

This shunt is mounted in a polished oak box with engraved bakelite panel. Separate pairs of binding posts are provided for the bridge and galvanometer connections.

PHANTOM ANTENNA RESISTOR

For many tests of transmitting apparatus, it is desirable to replace the antenna by a local circuit, the constants of which are more easily and accurately determined. It also prevents interfering with neighboring stations. The Type 125 Phantom Antenna Resistor (Fig. 200) is provided for this purpose.

These units are wound on asbestos-board forms, mounted vertically, an arrangement which insures a good circulation of air. The resistance



Fig. 198. General Radio Type 166 Telephone Transformer



Fig. 199. General Radio Type 210 Ratio Arm Box



Fig. 200. General Radio Type 125 Phantom Antenna Resistor

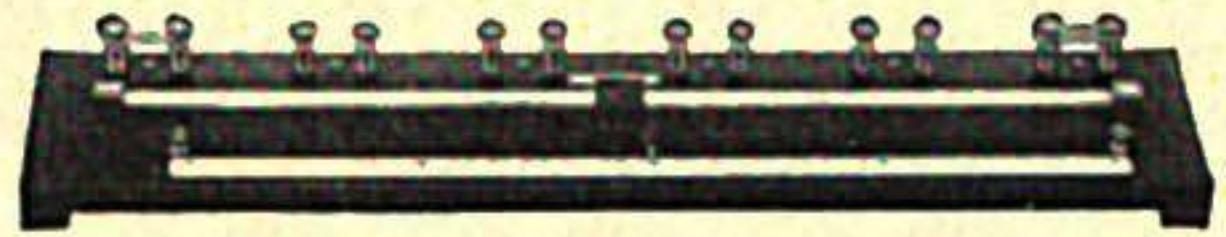

Fig. 201. General Radio Type 130 Slide Wire Bridge.



Fig. 202. General Radio Type 229 Universal Galvanometer Shunt



Fig. 203. General Radio Type 271 Med. Freq. Transformer

material is in the form of a ribbon, and has a very low temperature coefficient of resistance and a constant resistance up to very high frequencies. The inductance is very low and the resistance is accurately adjusted to the stated values.

The resistor is made in two sizes, Type 125A of 4 units of 4 ohms each, and Type 125G of 2 units of 2 ohms each. The separate units of Type 125A have a carrying capacity of 5 amperes and those of Type 125G 15 amperes. It is possible to connect these units so as to obtain different combinations of resistance and carrying capacity.

SLIDE WIRE BRIDGE

The design of this bridge (Fig. 201) is such as to permit of obtaining all the ordinary measurements made with a bridge and at the same time does not make the instrument bulky or heavy. The bridge is particularly adapted for class-room demonstration or student use where a variety of arrangements such as the Wheatstone, Kelvin, or Carey Foster circuits

are required. Great care has been used in the construction of this bridge. The base is of polished oak with engraved box-wood scale. The slider moves on a brass tube one-half inch in diameter, insuring good contact and durability. The slide wire is of manganin, one-half meter long, and has a resistance of approximately 0.9 ohm. Two pairs of binding posts are provided for extension coils to increase the range of the slide wire. Heavy copper connecting bars are used throughout. The metal parts are finished in dull nickel.

AUDIBILITY METER

If a telephone receiver in which signals are being received is shunted by a resistance until the signals are just audible, the ratio of the current in the telephone to the current in the shunt is an indication of the strength of the signals. For instance, if the signal is just audible when 99% of the detector current flows through the shunt and 1% through the telephone receivers, the signal is said to have an audibility of 100. If S is the impedance of the Shunt and T the impedance of the telephone receivers the audibility constant is given by the equation:

$$K = \frac{S+T}{S}$$

The increasing use of oscillating circuits for vacuum tube detectors has necessitated the development of a special type of meter for comparing the audibilities of signals. This is because the oscillating circuits are affected by changes in their constants, very slight changes often causing variations of telephone current quite out of proportion to the changes introduced. A series resistance must be added in the plate circuit to compensate for the reduction in resistance of that circuit caused by the shunting of the telephone receivers.

The Type 164 (Fig. 193) Audibility Meter is designed to keep the impedance of the oscillating circuit practically constant when used at 1,000 cycles. It is adapted for use with any good 2000 ohm telephone receiver. This meter consists of two sets of resistance units with thirty-two taps and reads directly in audibilities from 1 to 2000 by approximately 25% steps. As the first step has no resistance in shunt with the telephone receivers, the audibility meter may be left permanently connected in the circuit.

This instrument is mounted in a polished oak case with engraved bakelite panel. The metal parts are finished in polished nickel. The contact arm is of laminated phosphor bronze and insures perfect contact.

STANDARDS OF INDUCTANCE

These standards of inductance (Figs. 187 and 211) have been designed for general laboratory use and are suitable for radio frequencies as well as for commercial or audio frequencies. To minimize skin effects and eddy current losses the windings are of stranded wire with the separate strands insulated from each other. There is no metal in the field of the coils, in fact only a very small amount of metal, which is all non-magnetic, is used in the entire assembly of this instrument.

Considerable errors, particularly in bridge measurements, may be introduced if the inductance standards have a large outside field. To minimize this effect these standards are wound astatically, thus making the external field negligible. The use of the astatic winding eliminates the effects of other inductances in the vicinity of the standard.

The coils are form wound, firmly bound, and securely fastened to bakelite plates. As the final adjustment is accomplished by rotating one of the coils, it is possible to adjust these standards accurately to their specified values. The accuracy of this adjustment is one-tenth of one per cent. The current carrying capacity of the 1 millihenry and smaller size coils is 2 amperes, that of the 5 and 10 millihenry sizes 1 ampere, and that of the 100 millihenry coil $\frac{1}{2}$ ampere.

DECADE BRIDGE

The Type 193 (Fig. 197) Decade Bridge is designed to cover the many uses which are required of a laboratory bridge. It is adapted for both direct and alternating current measurements. While it is sufficiently flexible to give the necessary variety of connections demanded in the laboratory, when set up for commercial testing its operation becomes so simple that very little instruction is required by unskilled operators to make routine measurements.

The general arrangement of this bridge consists of three resistance arms, two of which are four dial decades each having a range of from 0.1 ohm to 1111 ohms. The third arm is a single dial having resistance combinations of 1-3-10-30-100-300 and 1000 ohms. In order to adapt this bridge for use with frequencies up to 10,000 cycles all resistance units are wound non-inductively and have very low distributed capacitance. This is accomplished by using the Ayrton-Perry Method of winding, previously explained.

The accuracy of adjustment of these coils is 0.1% on direct current and about 0.5% at 1,500,000 cycles. The wire used has a practically nil temperature co-efficient of resistance and contains no iron. The current

carrying capacity of the one-tenth ohm units is one ampere, that of the one ohm units one-quarter ampere, that of the ten ohm units one-tenth ampere, and that of the one hundred ohm units five-hundredths ampere.

Dial switches are used in place of the older and less satisfactory plug method of connection. This eliminates the inconvenience of the shifting of plugs, and also their possible loss. These switches have multiple-leaf contact brushes with each leaf making independent contact. The ends of the contact leaves are so cut that they are not tangent to the path of travel, thereby preventing the cutting of grooves in the contact studs. These switches have a low and constant resistance, even after long use. Attention is called to the fact that each decade dial has eleven contact studs, a zero and ten steps. This feature is especially important when working at the upper or lower ends of a dial.

The cabinet is of polished walnut, fitted with a copper lining to shield the resistance units from outside electrostatic fields. The panel is of polished hard rubber with engraved lettering. A complete wiring diagram is also engraved directly on the panel. The metal parts are finished in bright nickel. Insulated binding posts are used throughout. A tight fitting wooden dust cover is furnished with each bridge to protect the panel and switches when not in use.

Operation

The three general classes of measurements to which this bridge is adapted are direct current resistance by the Wheatstone method, inductance, and capacitance. For inductance and capacitance measurements an external standard is employed, while for resistance measurements one of the bridge arms is used as a standard. The circuits of the bridge are shown in the diagram.

The power source supplied to the bridge is connected to the binding posts marked BAT. For direct current resistance measurements this source is one or two cells of a battery, while for capacitance and inductance measurements an alternating current source must be used. The alternating current should be of known and constant frequency, and free from harmonics. The General Radio Co. Type 213 Audio Oscillator (Fig. 196) was designed for this work.

For direct current resistance measurements a sensitive galvanometer should be used to indicate the balance point. This galvanometer is connected between the GALV binding posts 1 and 2. When an alternating current source is supplied to the bridge in capacitance and inductance measurements, a sensitive telephone receiver or vibration

galvanometer is used to detect the balance point. This detector will be connected to either the GALV binding posts 1 and 2, or 2 and 3, depending on the conditions of balance.

To make a direct current resistance measurement by the Wheatstone method the resistance to be measured is connected to the binding posts marked X. A short circuit bar is placed between the STD binding posts. Arms A and B are used as ratio arms and Arm C adjusted to obtain a balance. The unknown resistance is then given by the expression

$$R_x = \frac{R_A}{R_B} \cdot R_C.$$

For inductance and capacitance measurements the bridge is used as an impedance bridge, that is, the bridge is simultaneously balanced for resistance and reactance. The inductance or capacitance to be measured is connected at X and the inductance or capacitance standard at STD. In this case Arms A and B are used as ratio arms and Arm C is a compensating resistance in order that the bridge may be in balance for resistance as well as for reactance. When the telephones, or vibration galvanometer, are connected between GALV binding posts 1 and 2, this compensating resistance is in series with the standard, and when the telephones are connected to binding posts 2 and 3 this compensating resistance is in series with the unknown impedance. The compensating resistance should be connected so as to be in series with the impedance having the lower resistance. At the balance point the following relationships exist between the unknown and the standard impedance.

$$\text{Inductance measurements } L_x = \frac{R_A}{R_B} \cdot L_s$$

$$\text{Capacitance measurements } C_x = \frac{R_B}{R_A} \cdot C_s$$

The Type 193 Decade Bridge (Fig. 197) is designed for general laboratory use. For direct current measurements its principal use is as a Wheatstone bridge. The connections are such, however, that the different arms may be used independently as standard decade resistance units. When used as an impedance bridge the range for capacitance measurements is from 0.003 to several microfarads, and for inductance measurements from about 20 microhenrys to several henrys. When making measurements of small capacitances or large inductances the sensitivity of the bridge may be increased by using in the detector circuit a telephone

transformer, such as the General Radio Co. Type 166 (Fig. 198). The high impedance side, which is marked SEC, is connected across the proper GALV binding posts and the telephone receivers connected across the low impedance side. Since all of the resistance units are wound non-inductively and to have very low distributed capacitance they are adapted for use at radio frequencies.

Since the bridge is so arranged that the individual arms are accessible, use may be made of the principle that in diagonal arms a capacitance will balance an inductance. By the correct choice of the inductance or capacitance standard, the bridge may be made direct reading in either capacitance or inductance. The precision of such measurements is that of the adjustment of the bridge, namely 0.1%.

CAPACITY BRIDGE

Description

There has long been a need for some simple yet reliable method of measuring capacitances as low as a few micromicrofarads with a precision of at least one-tenth of one percent. The desirability of a convenient, reliable, and accurate method of comparing the losses in small samples of dielectrics has also long been recognized. It was to meet these needs that the General Radio Co. Type 216 Capacity Bridge (Fig. 194) was designed.

Reduced to its simplest form, this bridge consists of a Wheatstone Bridge circuit with resistance in the ratio arms and capacitances in the unknown and standard arms.

The input source E is the General Radio Co. Type 213 1000-cycle Audio Oscillator (Fig. 196). This oscillator is connected to the input terminals "AC" of the bridge. These terminals lead to a shielded compartment containing an input transformer whose primary is grounded at its mid-point. The primary and secondary windings of this transformer are shielded from each other.

The bridge circuit consists of the two ratio arms M and N, and the Arms A and B in which the standard and the unknown condensers are placed. The junction point of the two ratio arms is grounded. These ratio arms are made up of equal resistance units wound on thin cards to reduce the inductance and the distributed capacitance. A method, however, is provided for adding resistance units to either the M or N arm in order to get small amounts of unbalancing. A four dial decade resistance box, the units of which are Ayrton-Perry non-inductive low distributed capacitance coils, is arranged so that it may be connected in

either the A or B arm by means of the switch F. A sensitive telephone receiver, or a vibration galvanometer, is used to detect the point of balance. This detector is connected to the bridge through a transformer which has a grounded shield between the primary and secondary windings.

The cabinet containing the bridge units is of polished walnut. All panels are of polished hard rubber with engraved lettering. The metal parts are finished in bright nickel. The interior of the cabinet is lined with copper, lacquered to retain its polished finish. The wiring, as well as the separate units of the bridge, is thoroughly shielded. Complete instructions accompany each bridge.

Operation

Since it is desired to detect minute changes in resistance and capacitance with this bridge it is very essential that each unit of the bridge be constructed to give a resultant maximum sensitivity. It is also very important that the supply source be of constant frequency and free from harmonics. Reliable readings for very small changes of capacitance cannot be obtained unless the supply source has a pure tone. It is for this reason that the Type No. 213 Audio Oscillator is recommended for use with this bridge.

The use of a supply transformer, instead of connecting the audio oscillator directly across the ratio arms, aids in the proper operation of the bridge. A shield, placed between the primary and secondary winding of this input transformer, prevents errors which would be caused by capacitance to earth of the supply source. In order that the potentials impressed across each of the ratio arms of the bridge shall be equal, the junction point of these arms and also the mid-point of the input transformer primary is grounded. The use of an input transformer increases the voltage applied to the bridge arms, a very desirable feature in the measurement of small capacitances.

Since the impedance of small capacitances at 1,000 cycles is high—that of 1,000 micromicrofarads being 160,000 ohms—it is desirable that a high impedance detector be used to denote the balance point of the bridge. As the impedance at 1,000 cycles of a pair of sensitive telephone receivers is only of the order of 20,000 ohms, it is evident that this is too low. For this reason a telephone transformer with a primary impedance of 200,000 ohms and a secondary impedance of 20,000 ohms is used. This arrangement provides the correct impedance in both the bridge and the telephone circuits and makes it possible to detect a very small difference in potential, such as that caused by the unbalancing of the con-

denser arms to the extent of one hundredth of a micromicrofarad. A shield similar to that of the input transformer is placed between the primary and secondary windings to prevent the introduction of errors caused by outside capacitances to earth.

As the bridge is designed primarily for the comparison of equal capacitances, the ratio arms are made equal. A variable standard low loss condenser such as the General Radio Co. Type 222 (Fig. 191) precision condenser is particularly adapted for use in the standard arm of the bridge. The use of equal ratio arms without any switches makes it possible to adjust these arms very accurately, and insures that their resistance will always be constant. Since these ratio arms are exactly alike, any change in inductance or capacitance with frequency will be the same in each arm, and will have no resultant effect on the balance of the bridge.

It is very often desirable to calibrate a vernier condenser whose total capacitance is of the order of three or four micromicrofarads. For this work the bridge is first balanced, using capacitances of the order of 1,000 micromicrofarads. If one of the resistance ratio arms were to be increased one part in one thousand, i.e., from 5,000 to 5,005 ohms, the ratio of the capacitances would be changed accordingly which is a change of one micromicrofarad. In order that the ratio arms may be changed in this manner, resistance units are supplied with the bridge. These units may be added to either ratio arm. Although the standard equipment of each bridge includes three of these resistance units so as to give ratios of unbalancing of .001, .01 and .1, they can be furnished to give any ratio desired.

In order to obtain a balance with a bridge of this type, the resistance as well as the reactance must be balanced. To provide this resistance balance a four-dial decade resistance unit may be placed in either the A or B arm. The shift is made by means of a single switch located on the side of the cabinet. The use of this decade resistance provides a convenient and accurate means of measuring dielectric losses.

A set of operating instructions covering in detail its uses and operation is supplied with each bridge.

Uses

The Type 216 Capacity Bridge is an instrument by means of which capacitances up to several microfarads can be measured quickly and accurately. It provides also a means of measuring capacitances as small as a few micromicrofarads to a precision of one hundredth of a micromicrofarad. Since the dielectric loss equivalent resistance at 1,000 cycles

can be measured to an ohm with this bridge, it is possible to obtain the phase angle of condensers or to compare different dielectrics. The testing of small samples of cable or the study of temperature changes in dielectrics is made easy because of the sensitivity of this instrument. An example of this latter use is a test made on a sample of hard rubber. The sample which was 3 inches square and one-half inch thick was placed between two metal plates. At 54° F. this sample had a capacitance of 11.20 micromicrofarads and a phase angle of 48'. When heated to 100° F. the capacitance had increased to 12.25 micromicrofarads and the phase angle to 1° 55'.

COMBINATION WAVEMETER AND FILTER

With the large number of broadcasting stations operating there are few locations where it is not often desirable to eliminate some interfering station. Unless the wavelength separation is large this elimination can seldom be obtained by the usual tuning methods. Oftentimes there is general interference which it is desired to reduce. These results may be accomplished by the use of the Type 305 Radio Filter (Fig. 192). This instrument consists of a tuned circuit inductively coupled to a coil placed in the antenna circuit. To use this filter it is necessary only to connect the antenna and ground wires to two binding posts on the input side of the filter and the receiving set to two binding posts on the output side. All necessary changes in connections are made by a single selector switch. As this switch is provided with an off position the filter may be left permanently connected and used only when desired. This selector switch enables the filter to be used as either a rejector or acceptor without the necessity of changing a single external connection. The condenser is a special model of our low loss, gear controlled Type 247 with plates shaped so as to give a nearly uniform wave length scale. The coils are

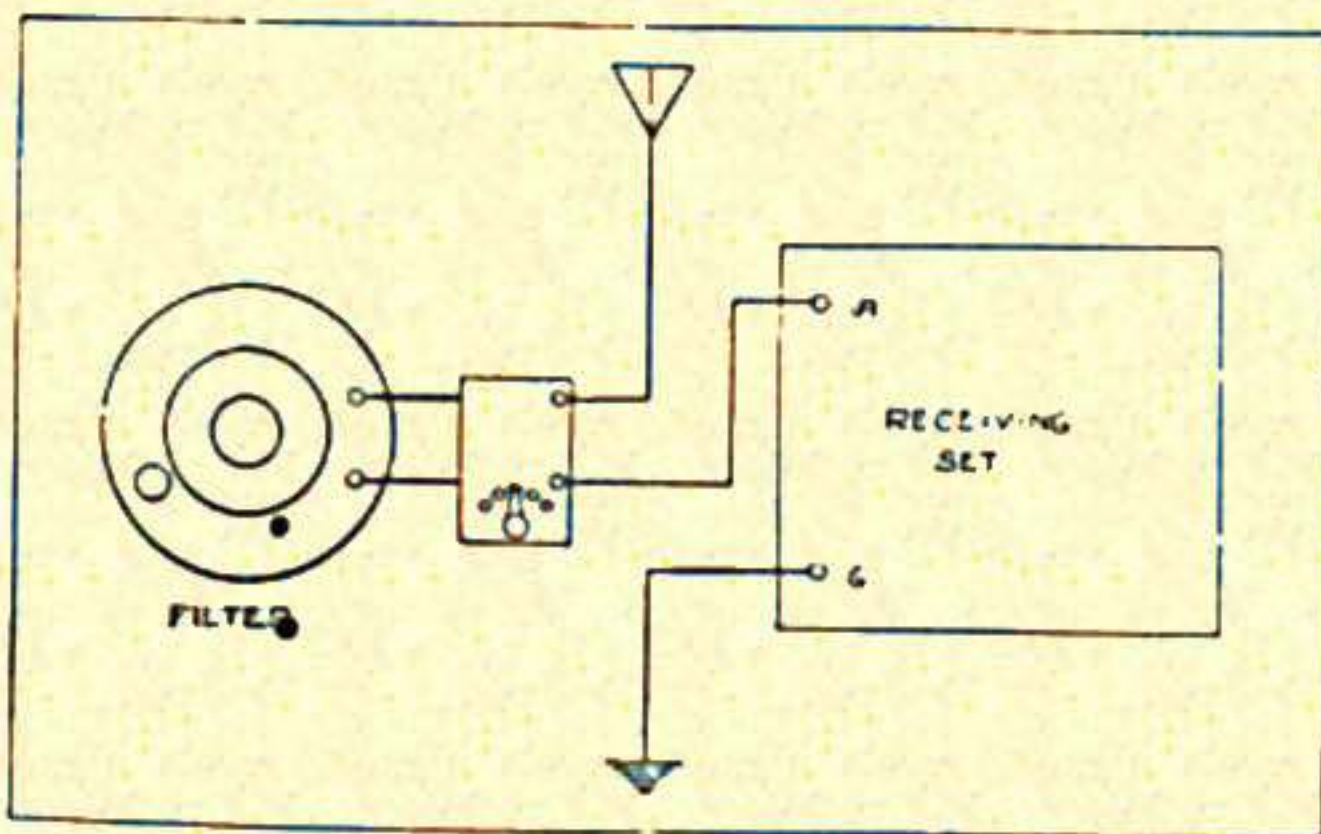

Fig. 204. Series Connection for Wave Meter and Filter

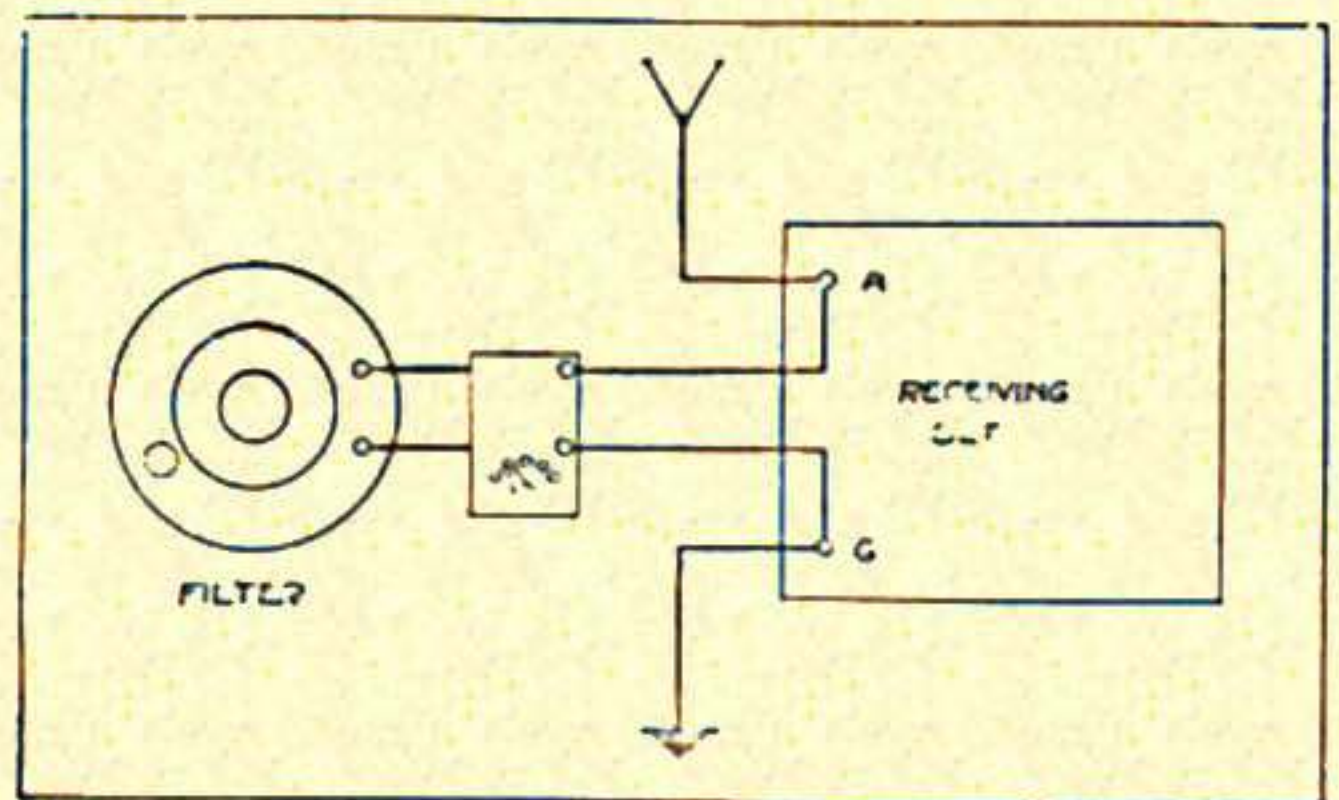

Fig. 205. Parallel Connection for Wave Meter and Filter

wound with sufficiently large wire to give the circuit a low decrement, and the number of turns of the antenna coil are controlled by the selector switch. One of the valuable features of the instrument is the wavelength scale marked directly on the condenser dial. This scale, calibrated to within 2%, not only aids in the setting of the filter, but also enables the filter to be used as a wavemeter. The scale is calibrated from 150 to 500 meters, which is the working range of the filter. The entire equipment is mounted on a bakelite panel and enclosed in a polished walnut cabinet. The metal parts are finished in polished nickel.

OPERATION

The filter can be used with any antenna connected receiving set to improve the selectivity; the improvement being more noticeable when used with the single circuit type than with the inductively coupled type of receiver. When used with a crystal receiver the operation of the filter is quite simple, but some practice is necessary to get the best results when using it with a regenerative tube set, especially when the Parallel Filter is used. The external connections are the same for all uses of the filter. The antenna is connected to the binding post marked A and the ground to G. The binding posts of the receiving set that ordinarily would be connected to antenna and ground should be connected to the two filter binding posts marked REC. SET. When the white indicator line of the filter selector switch is set opposite the contact marked O the filter is disconnected and the receiving set may be used just as if the filter were not present.

1. THE SERIES FILTER. When the selector switch is set opposite the contacts marked 8 or 5 of the SER side, the connections are as shown in Fig. 204. It will be seen that the filter is connected in series with the antenna. If the wavelength scale of the filter condenser is then set at some point such as 360 meters any incoming signal of this wavelength will be prevented from reaching the receiving set. This is due to the counter-electromotive force set up in the resonance circuit of the filter. The effectiveness of the filter in cutting out a station depends on the sharpness of the tuning of the station. For this reason spark stations cannot be eliminated effectively by the series filter. The parallel filter must be used for such cases.

When it is desired to eliminate a single broadcasting or other continuous wave station set the filter switch at O and tune the receiving set until the undesirable station is received with maximum intensity. Then set the filter switch on point 8 of the SER (series) side and turn the wavelength scale slowly until the station disappears and comes back

again. Rotate the dial back and forth, using the vernier knob, until the point of minimum intensity is found. Leaving the filter set at this point the receiving set may be re-tuned to whatever wavelength is desired. If this wavelength is more than 10 meters away from that of the interfering station usually no interference will be experienced.

If the interfering station signal intensity is small compared with that of the desired station the filter switch may be set on point 5 instead of 8. These numbers refer to turns on the coupling coil. The more turns used the more effective the filtering action, but a broader neutralized band is obtained.

When cutting out an interfering station by the series connection, there will be no reduction of signals on wavelengths differing by a few meters from the filter setting. The wavelength of the interfering station may be read from the setting of the filter condenser dial.

2. THE PARALLEL FILTER. When the selector switch is set on the PAR (parallel) side the connections are as shown in Fig. 205. It will be seen that the filter is connected in parallel with the receiving set and forms a short circuit between the antenna and ground. Incoming signals of the same wavelength as that for which the filter is set build up a voltage across the terminals of the filter which is impressed on the input of the receiver. Signals of all other wavelengths are not in resonance with the filter and pass to the ground as if short circuited. It will thus be seen that when set for the parallel position the filter will permit only signals of one wavelength to reach the receiving set. These signals, however, will be reduced somewhat in strength, due to unavoidable losses in the filter circuit, so that it is possible to use the parallel connection only with signals of at least moderate intensity.

When it is desired to receive from a single station only, set the filter switch at O and tune the receiving set so as to receive the desired station at maximum intensity. Set the filter switch on 5 of the PAR side and carefully turn the wavelength dial until the signals are again heard with maximum intensity. Further improvement will be obtained by re-tuning the receiving set and making any further readjustment necessary on the filter. The best results will be obtained using the parallel connection after experience is obtained in the retuning adjustments. The tuning of the filter is very critical and care must be taken in making settings.

The parallel connection will be found particularly helpful when it is desired to listen to a broadcast program without the annoyance of radio telegraph interference.



Fig. 206. General Radio Type 174
Wave Meter

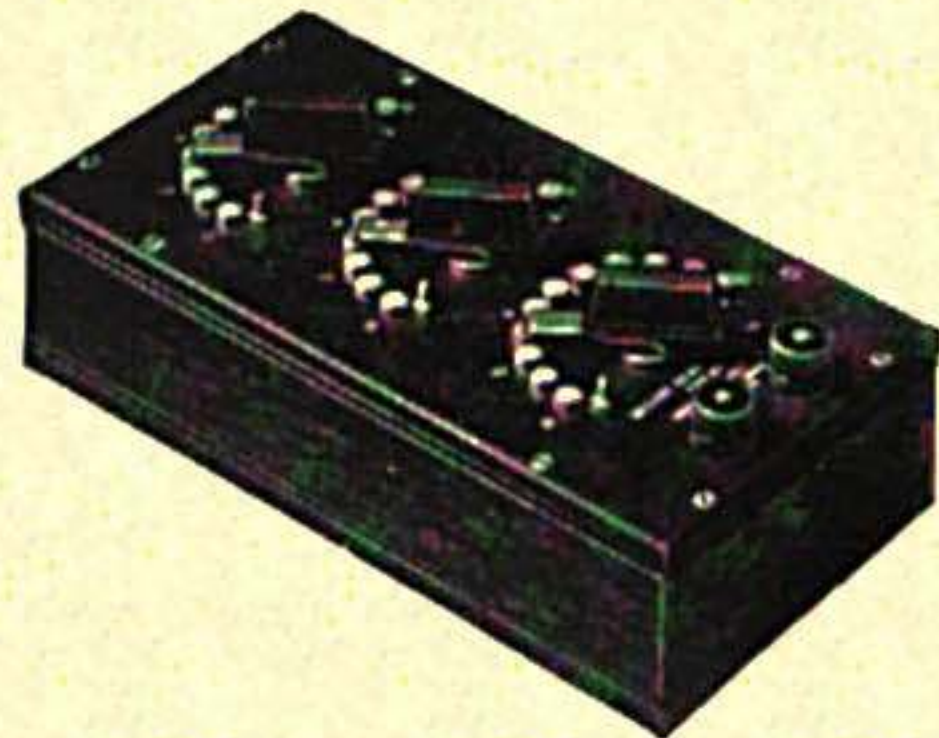

Fig. 207. General Radio Type 102
Decade Resistance Box

3. USE AS WAVEMETER. Wavelengths of received signals may be measured directly with an accuracy of 2%. To do this set the filter switch on O and tune the receiving set to the desired station; then set the filter switch on 5 of the SER side and turn the wavelength scale until the signal disappears. The reading on the wavelength dial is that of the incoming signal.

AUDIO OSCILLATOR

The precision of most alternating current bridge measurements is in no small measure dependent on the source of power supplied to the bridge. The waveform should be practically free from harmonics. Where a balance is indicated by means of the null method with a telephone receiver, the presence of harmonics of even very small magnitude will prevent the accurate determination of the balance point for the fundamental. The frequency must remain constant. The supply source should also be simple in its operation, rugged and reliable. It was to meet these requirements that the General Radio Co. Type 213 Audio Oscillator (Fig. 196) was designed.

The output of this oscillator is about 0.06 watt at 1,000 cycles. External binding posts are so arranged that three output voltages may be obtained. The outputs obtainable with these three different connections are as follows:

<i>Point</i>	<i>Voltage</i>	<i>Current</i>
Low	0.5 volts	100 milliamperes
Medium	1.5 volts	40 milliamperes
High	5.0 volts	12 milliamperes

For some capacitance measurements it is desirable to use a high voltage. This increased voltage may be obtained by connecting an inductance and capacitance in series across the high voltage output terminals of the oscillator. By adjusting this circuit to resonance, voltages as high as 50 or 100 may be obtained by connecting output leads across the condenser. This instrument will operate satisfactorily on from four to eight volts. The input current is approximately 0.13 ampere. When running, the oscillator may be heard for a distance of approximately twenty-five feet, or may be made silent by enclosing in a sound-proof box.

The closing of the switch places the field magnetizing coil directly across the battery. Also across the battery is the primary of the input transformer in series with the microphone button. The resonance circuit consists of the secondary of the input transformer, the primary of the output transformer, the armature coil and the condenser. The output transformer secondary has three taps to permit the obtaining of three different output voltages. The use of the two transformers prevents the output wave from containing any direct current component. Each transformer core has a small air gap to prevent distortion of the wave form. Since, however, the magnetic circuits are all nearly closed iron paths there is very little outside field. This feature is particularly important where the oscillator is being used in close proximity to the bridge. The tuning fork insures that the frequency be kept constant and at 1,000 cycles. The resonance circuit is carefully adjusted to this value. Since the oscillator is self-starting it may be located at a point distant from the bridge and operated by a switch placed at the bridge.

By the use of the field magnetizing coil on one tine of the vibrating fork, instead of relying on its permanent magnetism, the polarity and intensity of the magnetization of the fork with respect to the armature are permanently maintained.

Success or failure in the operation of a hummer, or audio oscillator, lies very largely in the microphone button. If the button heats so that the oscillator cannot be run indefinitely, if the adjustment of the button is not permanent, or if slight mechanical shocks change its operating characteristics the oscillator has little commercial value. A distortion of as small an amount as one five-hundredth of an inch from normal mica will destroy the perfect operation of the button. In order that the button may be insensitive to mechanical shocks and yet operate properly at 1,000 cycles, use is made of its high inertia effect at the latter frequency. One side of the button is attached to the tuning fork by means of a short, flat spring. The other side, which has a projecting mounting post,

is held in position by a specially designed self-centering spring. This combination of springs enables the button to withstand severe shocks, yet it has sufficient inertia so that perfect operation is obtained. The adjustment of the button is permanent and needs no further attention after leaving G. R. laboratory. This type of mounting, together with the fact that the electrical constants of the circuits have been adjusted to their optimum values, insures the continuous operation of the oscillator without heating.

It should, of course, be understood that this oscillator is not intended to displace the larger types of oscillators used where several watts of output are required. It is intended rather for general laboratory use where power of good waveform is desired for a single bridge. As the pureness of waveform is dependent on the load on the oscillator, whenever a pure waveform is essential the oscillator should not be overloaded. This oscillator is adapted for the usual alternating current measurements of inductance and capacitance.

The oscillator is mounted in a polished oak box and has an engraved bakelite panel. The exposed metal parts are finished in polished nickel. The control switch is easily accessible and is of the convenient lock button design.

TELEPHONE TRANSFORMER

For many purposes in a laboratory a small iron core transformer of high and adjustable impedance is extremely useful (Fig. 198). It may be used to advantage in impedance bridges employing a telephone receiver to detect the balance point. With this transformer it is possible to adjust the impedance of the telephone circuit to the most satisfactory value for the bridge circuit, independent of the telephone receiver impedance.

The winding is all on one leg of the core, but is in two separate parts so as to be used as a primary and secondary. These windings, however, may be connected in series should it be desired to use an auto transformer connection. Taps are brought out on both the primary and secondary windings so that it is possible to vary the impedance and the ratio of transformation. A small air gap is left in the iron core to prevent any possible distortion of waveform due to saturation of the iron. The panel is of bakelite with engraved lettering. Nickel plated binding posts are used as terminals for the taps. The following table shows the number of turns between each set of binding posts.

PRIMARY	SECONDARY
1-2.....150 Turns	5-6.....1,200 Turns
2-3.....300 Turns	6-7.....2,400 Turns
3-4.....600 Turns	7-8.....4,800 Turns

DIRECT READING WAVEMETER

The Type 174 Wavemeter (Fig. 206) is designed for general use in commercial and experimental radio stations. Its equipment is such that it is adapted for use with receiving or transmitting sets, employing either damped or undamped waves. Its self-contained, direct-reading features make this instrument particularly valuable for commercial work.

A hot wire galvanometer is used for indicating resonance of transmitted signals of average intensity, while for weak signals a crystal detector and binding posts for telephones are provided. For producing damped oscillations of known wavelengths, the wavemeter is equipped with a high frequency buzzer operating on a battery mounted within the wavemeter case. The oscillating circuit consists of three coils with a selector switch and a variable air condenser. This combination gives a wavelength range of 130 to 3,000 meters. The inductance coils are bank-wound in order to keep the distributed capacity a minimum. The condenser is our low loss Type 239, equipped with slow-motion gear.

Particular care has been given to the mechanical construction and to the appearance of this instrument. All of the equipment is mounted on a hard rubber panel and enclosed in a polished walnut carrying case fitted with lock and key. The metal parts are finished in polished nickel.

OPERATION

The dial on which are drawn the three wavelength scales corresponding to the three inductance coils is mounted directly above the variable condenser and is fastened to the rotor plate shaft. The scales are indicated by the numbers 1, 2 and 3 engraved on the panel. Above the galvanometer is a switch engraved RANGE, with points numbered 1, 2 and 3. These three points correspond respectively to the three wavelength scales. Thus, when the wavemeter is set say at 360 meters, Scale 1 is used and the range switch set on Point 1. In addition to the three wavelength scales, a scale divided into one hundred equal divisions is provided. This scale is simply placed for reference, and is convenient in making certain measurements.

TRANSMITTING SETS

In determining the wavelength of a transmitting set, the range switch should be set on the point covering the wavelength scale within which the transmitted wavelength should fall. The wavemeter should then be brought near the tuning inductance or the antenna or ground lead of the transmitter. By turning the knurled knob marked IN-

CREASE WAVELENGTH, the variable condenser will be rotated, varying the wavelength of the wavemeter. At resonance—that is, the point where the wavelength of the wavemeter is the same as that of the transmitter—the maximum amount of energy will be transferred from the transmitting set to the wavemeter. This point is indicated by a maximum deflection of the hot wire galvanometer. Care, however, should be taken that the wavemeter is not too near a powerful transmitter because an excess amount of energy may be transferred to the wavemeter, causing the galvanometer to burn out. It will be found that with a sharply tuned transmitter, particularly when using vacuum tubes, that the resonance point is very sharp. The condenser must be rotated slowly, as the galvanometer needle will swing from zero to nearly full scale and back again over a very small range of wavelengths. If the condenser is rotated too rapidly, the resonance point will be passed through without being noted. In the case of a buzzer or transmitter of small output, sufficient energy may not be radiated to operate the galvanometer. In this case, a pair of telephones should be connected to the binding posts marked TEL. Resonance will then be indicated by maximum intensity of signal in the telephones.

The Type 247W Wavemeter and Filter (Fig. 208) consists of a wavemeter inductance connected to a Type 247W Condenser (500 MMF.). In order that this same instrument may be used as a filter, a coupling coil is placed beneath the wavemeter winding. The number of active turns of this coil may be varied by means of a switch, which also serves to either disconnect or short-circuit the coupling coil.

I. HOW TO USE THE FILTER.

The filter can be used with any receiving set to improve the selectivity; the improvement being more noticeable when used with the single-circuit type than with the inductively coupled type of receiver. When used with a crystal receiver the operation of the filter is quite simple, but some practice is necessary to get best results when using it with a regenerative tube set, especially when the parallel Filter is used.

1. **THE SERIES FILTER.** When troubled by interference from a nearby broadcasting station, break the antenna lead to your receiver and insert the coupling coil.

Set the switch on tap 8 (8 turns in the coupling coil) and slowly rotate the condenser knob until the desired signal decreases, vanishes and again increases. Using the small knob, pass slowly back and forth over this point until the position for minimum interfering signal is located. The filter is now set for this one interfering station, (its wave-

length in meters can be read from the condenser scale). Both the interference and the filter may now be forgotten and the receiving set tuned to distant stations in the usual manner.

Use of the switch: Place switch on "O" to entirely cut the filter out of the circuit, on "3" or "5" for moderate interference, and on "8" for strong interference.

Do not try to use a series filter to cut out spark stations. The parallel filter is used for this purpose.

2. THE PARALLEL FILTER. The parallel filter is used to reduce interference from: spark transmitters, static, A.C. hum and similar sources. It will also allow you to tune out several local stations broadcasting simultaneously, and receive from a broadcasting station on a wavelength differing by only a few meters from the nearest interfering wave.

Set the switch on "Open," and tune your receiver to the desired station. Then move the filter switch to contact 8 and all signals will disappear until the filter condenser is adjusted to exactly the wavelength of the desired station. The wavelength markings on the dial are a help if the desired wavelength is known. Listen closely for your station while slowly moving the filter condenser back and forth over the approximately wavelength of the station. Use the small knob and tune carefully, because $\frac{1}{2}$ of one degree on the condenser dial is enough to tune the desired station in or out. Most people are not accustomed to the highly desirable sharp-tuning which is obtained from this radio filter, and therefore, pass over the proper setting without noticing the signal. Practice first on tuning in a loud broadcasting station. After the filter has been carefully adjusted for maximum signal strength, slightly retune the receiver, making a change in the amount of regeneration, if necessary.

Use of the switch: Place switch on "Open" to entirely disconnect filter from receiver, on "8" or "5" for moderate interference and on "3" for strong interference.

II. HOW TO USE THE WAVEMETER.

1. To Measure the Wavelength of a Received Signal. Wavelengths from 150 to 500 meters may be measured with an accuracy of 2%. To measure the wavelength of an incoming signal connect the coupling coil in series with the antenna as described above under "Series Filter." Set the switch on "3" or "5" and carefully rotate the wavemeter condenser until the signal is filtered out. The wavelength is then read from the condenser dial.

2. **To Set Your Receiver to a Predetermined Wavelength.** It is often desirable when listening for a certain broadcasting station to adjust your receiver to the proper wavelength before transmission begins. Many experimenters also find it convenient to have their tuning controls calibrated in wavelengths. This wavemeter can be used for this purpose only with regenerative receivers. With the usual single-circuit tuner, the operator should make the detector tube oscillate at approximately the desired wavelength. The wavemeter is then brought near the antenna tuning inductance and the condenser slowly rotated until a double click is heard in the telephone receivers. This click is due to a sudden change in current through the telephones. When the wavemeter is tuned to the wavelength of the oscillating tube it withdraws sufficient energy from the tube to momentarily stop it oscillating and a click in the telephones results; another click is heard when the tube again begins to oscillate. If the two clicks occur 30 or 40 meters apart, the coupling between the wavemeter and the receiver should be loosened by moving the wavemeter coil farther away until the two clicks merge into one. After a little practice in noting the indication of resonance by the double click method, you are ready to set your receiver to the desired wavelength, say 410 meters. Set the wavemeter at 410 meters and slowly vary the wavelength of your receiving set while it is oscillating. Listen for the double click when the receiver is in tune with the wavemeter. Move the wavemeter far enough away so that the two clicks occur very close together. The receiver is now tuned to 410 meters. If the means for controlling regeneration on the receiver is altered, the wavelength will vary slightly, but this variation is usually less than three meters.

With an inductively-coupled receiver, disconnect the antenna and proceed as mentioned in the foregoing paragraph, coupling the wavemeter to the secondary circuit of the receiver. After this circuit is tuned to the proper wavelength, the operator should reconnect the aerial and retune the antenna circuit to the secondary circuit by means of the double click method, using only sufficient coupling in the vario-coupler to make the double clicks come close together. Incidentally, this easy and accurate method of tuning the primary to the secondary wavelength is not as widely known, or used, as it should be.

3. **How to Measure the Wavelength of a Transmitter.** (A) C. W. and Radiophone Transmitters. To measure the wavelength of a C. W. Transmitter with a Type 247W Wavemeter, the operator makes use of the Reaction Method to indicate resonance. With the C. W. Transmitter in operation, the wavemeter is brought near the antenna tuning inductance (about six inches away), and the condenser dial is slowly

rotated until the wavemeter is brought into resonance with the transmitter as is indicated by a sharp reaction on both the plate and antenna ammeters. The plate ammeter, if used, is usually the better indicator to watch, because it is quick acting. After a downward kick is noted on the indicating meter, the wavemeter condenser is then slowly rotated back and forth by means of the small knob, until the reading of the indicating meter is a minimum. The wavelength of the transmitter is then obtained by reading the wavemeter scale. The coupling between the wavemeter and the antenna tuning inductance should be only sufficient to cause the least reaction which can be easily observed on the indicating meter.

(B) **Spark Transmitters.** When measuring the wavelength of a spark transmitter, it is suggested that resonance between the wavemeter and the transmitter be indicated by the use of an ignition tester sold by automobile supply stores for testing spark plugs. These testers contain a tube filled with a gas Neon which lights up if held in the hand and touched to the left-hand binding post on the wavemeter condenser when the wavemeter is absorbing power from the transmitter.

Two methods of determining the wavelength of a receiving set may be employed. The first, the reaction method, is applicable only to a vacuum tube receiving set, and then only when the set is oscillating. The wavemeter should be brought near the tuning inductance of the receiving set. By tuning the condenser of the wavemeter a sharp click will be heard in the head phones of the receiving set at the point where the condenser passes through the resonance point. The wavelength would then be read on the proper scale. It is usually necessary to have the wavemeter quite close to the receiving set. As the axis of the coils in the wavemeter is parallel to the panel, and extends from front to rear of the case directly beneath the galvanometer, best results are usually obtained by placing the right-hand edge of the wavemeter parallel to the tuning coil of the receiving set.

Where it is desired to set an inductively-coupled receiving set at a definite wavelength, the wavemeter should be set at that wavelength and the antenna circuit of the receiving set opened. The secondary of the receiving set should be adjusted either by means of the inductance or condenser until the reaction click is heard in the head phones of the receiving set. The wavemeter is then removed and the antenna circuit connected. The antenna circuit should then be varied until a click is again heard in the head phones. This will indicate that the primary and secondary circuits of the receiving set are both adjusted to the same value and to the value set on the wavemeter. This method requires, of course, that the set be oscillating during adjustment.

Where a single circuit receiving set is used, the antenna and ground connections should be left on. The tuning condenser is varied until the reaction click is heard in the telephone receivers. As with the inductively-coupled receiving set, the vacuum tube must be oscillating while the wavelength adjustments are being made.

A much quicker but slightly less accurate way to adjust the receiver is by means of the buzzer on the wavemeter. The wavemeter is set at the desired wavelength and the buzzer turned on by means of the buzzer switch. The receiving set should then be adjusted until the maximum intensity of buzzer signal is heard in the head phones. This method of adjustment is similar to tuning to an incoming signal.

AMPLIFIER UNIT

Simplicity in an amplifying unit is just as essential as in any other part of a radio receiver. The experienced radioman now recognizes that best results are obtained consistently by the correct use of properly designed instruments, rather than resorting to complex, and often unreliable, circuits.

With this idea of simplicity G. R. has developed a convenient and efficient audio frequency amplifier unit (G. R. Type 300). This unit is self-contained except for the batteries and receivers. It is ready for connection to your detector set, and it may be used with crystal or tube detector with equal efficiency.

This unit is so arranged that it may be used on a table or mounted behind a panel. When mounted behind a panel, only the rheostat knob is visible in front of the panel. Convenient mounting holes are provided for either panel or table installation.

For persons building their own sets, these units are very convenient because of the panel mounting feature. As the bracket is self-supporting, it is only necessary to screw the unit to the panel. Two or more of these units may be used to obtain multi-stage amplification.

The parts used in this unit are G. R. standard instruments, a detailed description of which will be found in the following pages of this book. All necessary wiring has been provided. The mounting bracket is of heavy brass with a white nickel finish. With each unit there is supplied a sheet showing a wiring diagram and giving operating instructions.

This unit is made up in two models, 300-D for the standard base tubes, such as the UV-201A, and 300-C for the UV-199 tubes. The only difference is in the socket. Both of these tubes may be operated from dry cells.

FOUR-STEP INDUCTOR

The tuned circuits of an experimental radio receiving station must be capable of operating over a wide range. They should extend from 150 meters to above 20,000 meters. It is impractical to construct a single coil, even when equipped with a slider and sectionalizing switches to cover this entire range. It has become common practice to employ several sets of coils to cover this range. If coils without taps are used, the number required is so large that it is inconvenient to make the many changes required when working at a variety of wavelengths.

We have designed a set of four coils, each with four taps (G. R. Type 226), which are particularly adapted for use in radio receiving sets. Although built with four different values of inductance they have the same physical dimensions, thus permitting two or more circuits to be coupled together. By working at the extreme limits of each coil it would be possible to cover the range referred to above with three sizes instead of four. The four sizes, however, give a much greater flexibility than do three.

The coils are approximately of Maxwellian shape. The winding is such as to keep the distributed capacitance a minimum. This is a particularly important feature in that it increases the range over which any one coil may be used, and what is more important, it increases the efficiency of the coil by keeping the dielectric losses a minimum. These coils are rugged in construction and attractive in appearance. The case is of polished oak with engraved bakelite panel. The metal parts are finished in polished nickel.

One very distinctive feature about these coils is that they are self-supporting and, accordingly, do not require any auxiliary mounting. Coupling between coils is varied by simply changing the distance be-

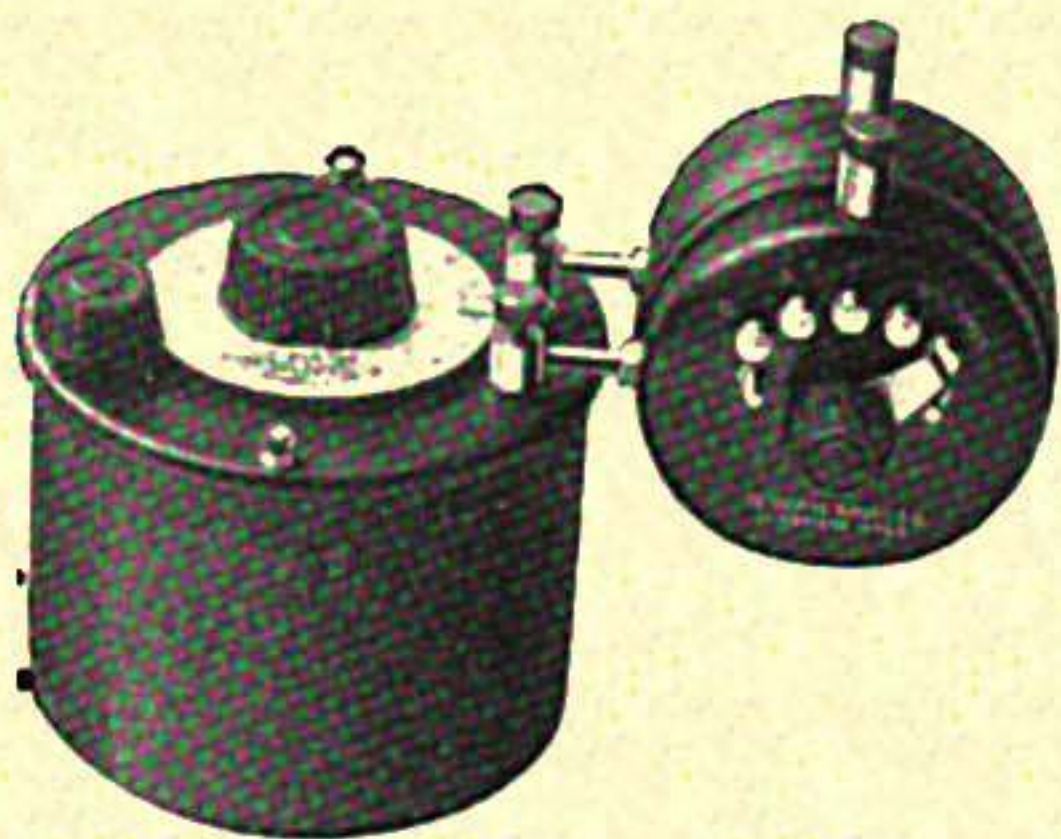

Fig. 208. General Radio Type 247W
Wavemeter and Filter

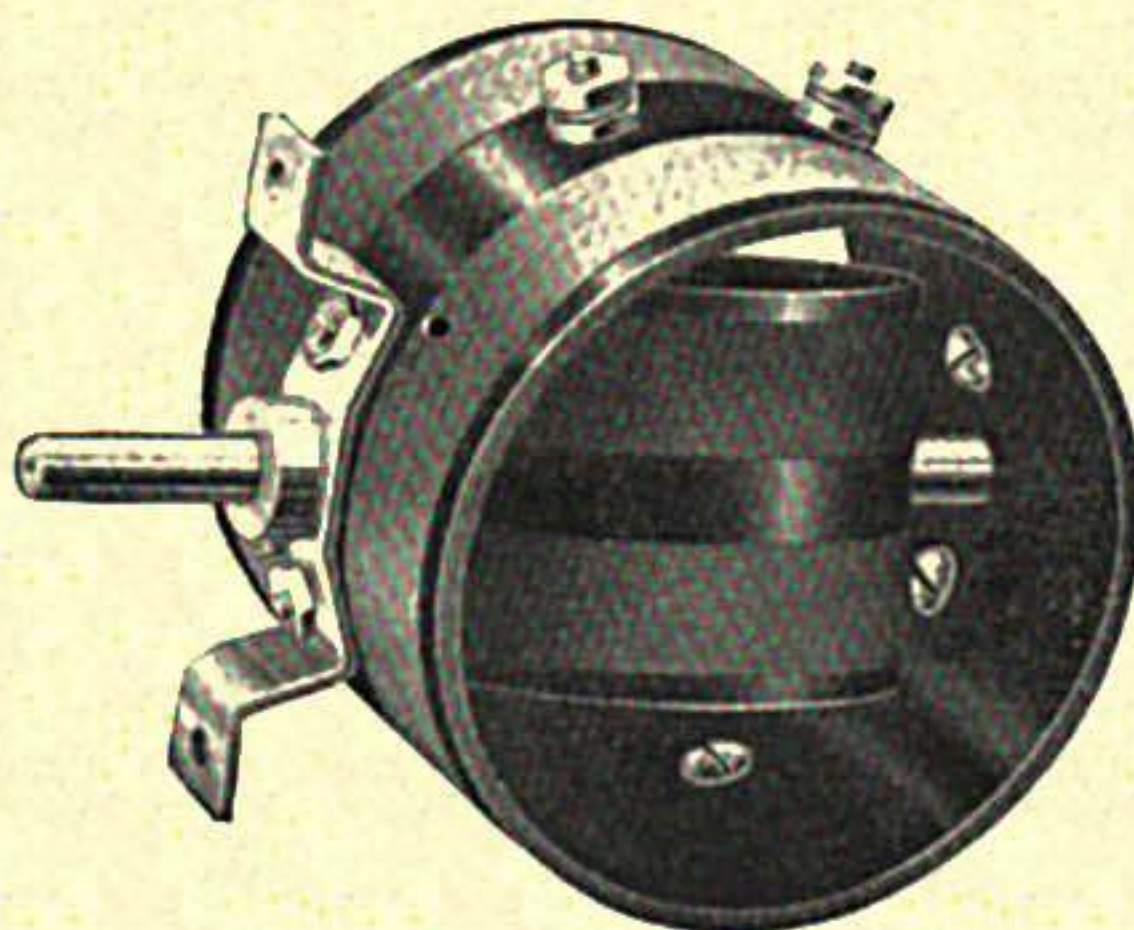

Fig. 209. General Radio Type 268
Vario-Coupler

tween coils or by turning through any desired angle. The arrangement of taps is such as to give values of approximately 20%, 45%, 75% and 100% of the maximum inductance.

HIGH FREQUENCY BUZZER

This buzzer (Fig. 186) has been designed for both laboratory and radio use. It combines pureness of tone, simplicity of adjustment and durability.

The frequency is approximately 800 cycles, but depends on the setting of the knurled adjusting screw. As the current required for the operation of the buzzer is approximately only 30 milli-amperes, it may be operated for long periods of time from small batteries. One dry cell will provide sufficient potential to operate this buzzer satisfactorily.

One of the noteworthy features of this buzzer is its freedom from sparking. This is important where pure tones are required. This feature makes the buzzer particularly adapted as a supply source for bridge measurements and for continuous wave telegraph modulation.

INSULATORS

Porcelain, which has losses but one-tenth that of the usual moulded materials, is rapidly becoming the standard material for insulators.

For antenna insulation, correctly designed porcelain strain insulators are to be preferred to other commercial types. The Tye G. R. 280 Strain Insulator, will be found particularly satisfactory. It is made of carefully glazed brown porcelain and will withstand severe weather conditions.

Another convenient insulator is the G. R. Type 260. It may be used inside to support wiring or instruments, or may be used outside for supporting lead-in or ground wires. Two of these insulators with a threaded rod connecting them make an excellent lead in combination. As they are also constructed of glazed brown porcelain they may be used either indoors or out. Each insulator is equipped with nuts and washers assembled. Three polished nickel mounting screws are also provided.

VERNIER CONDENSER

The increasing use of vacuum tube oscillating circuits where resonance is very sharply defined has created a demand for a variable condenser of small capacitance. Very often a movement of less than a single division on the ordinary variable air condenser will go beyond the resonance point. The G. R. Type 169 Vernier Condenser has been designed to go

in parallel with the ordinary variable condenser so as to obtain a very fine adjustment. The spacing of the terminals is so arranged that this condenser may be slipped directly across the binding posts of any of our other condensers, thus permitting a parallel connection without using connecting wires.

The stationary plate may be varied in distance from the moving plate, thus permitting a variation in maximum capacitance from about .5 to 10 micromicrofarads. A hard rubber extension handle is provided to avoid effects from placing the hand too near the condenser.

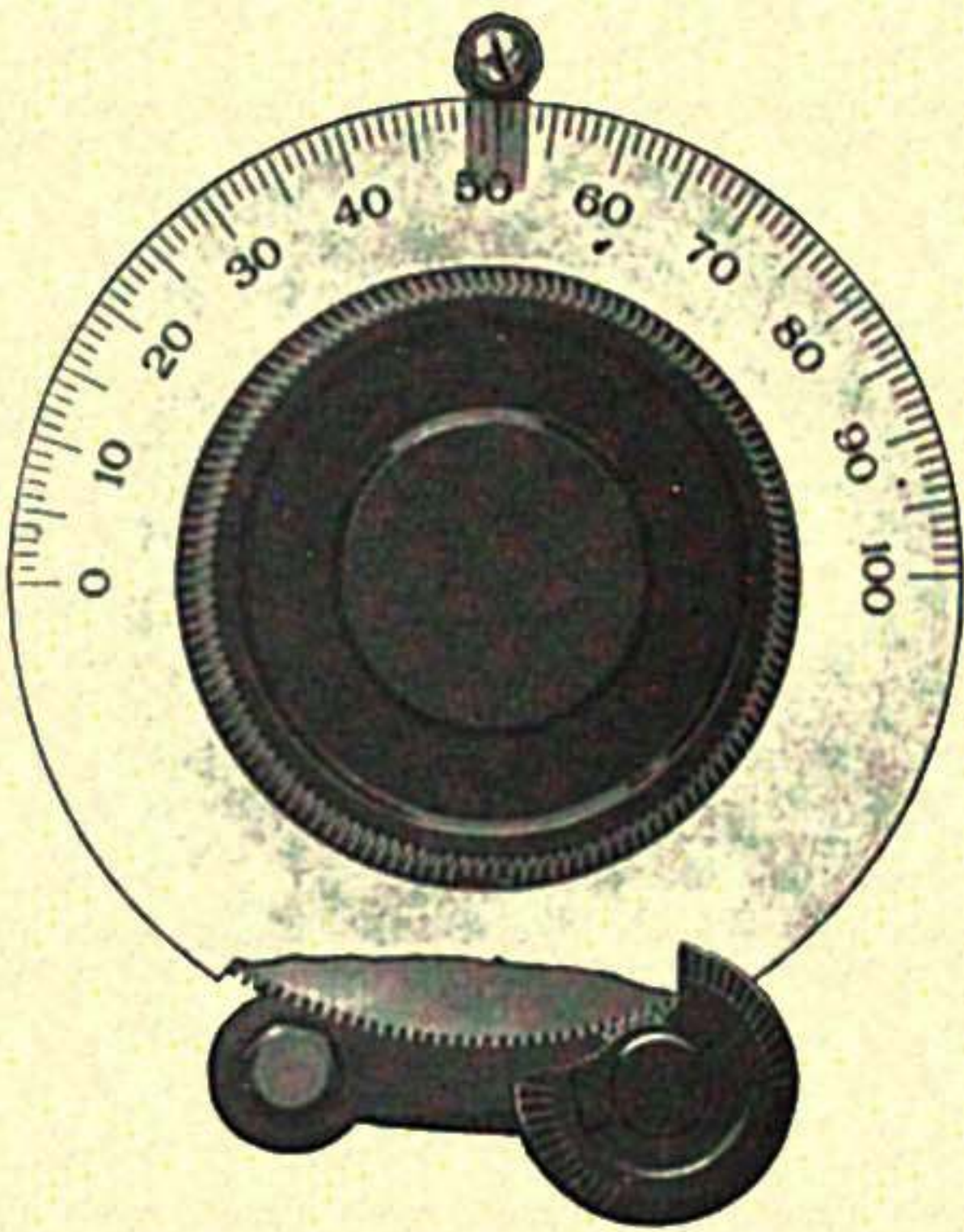

Fig. 210. General Radio Geared Dial

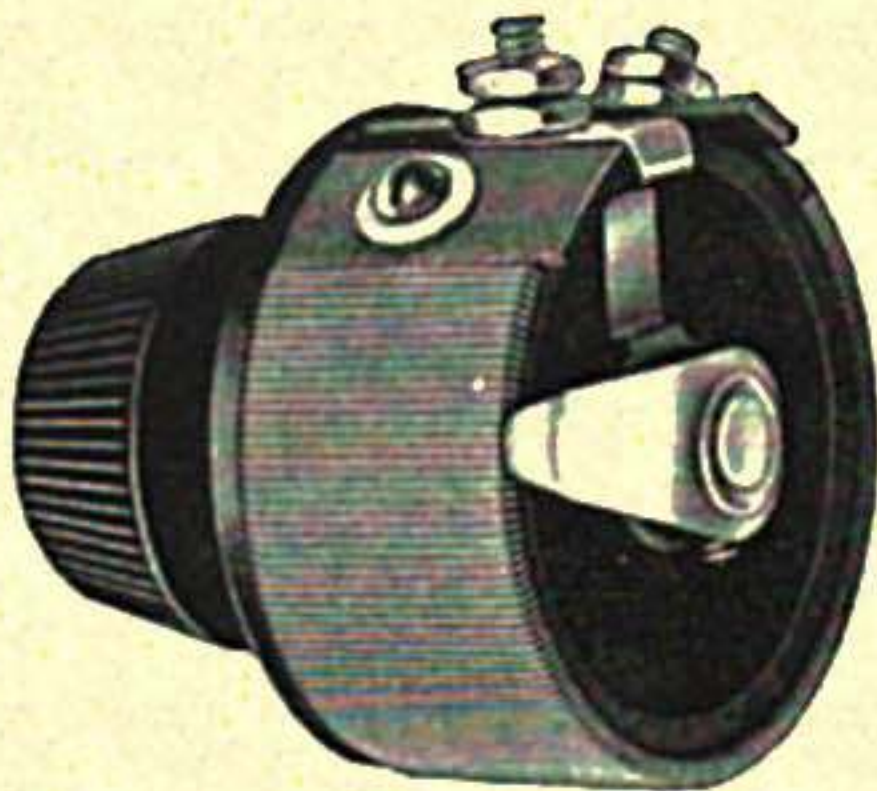

Fig. 212. General Radio Type 301 Rheostat

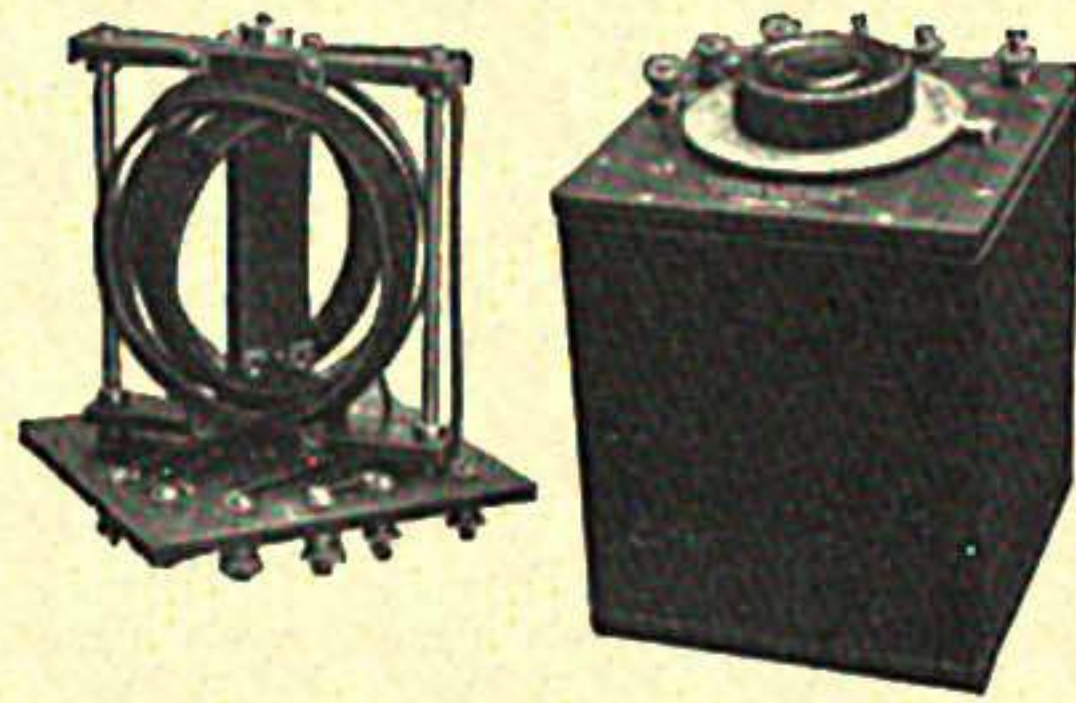

Fig. 211. General Radio Type 107 Variometer

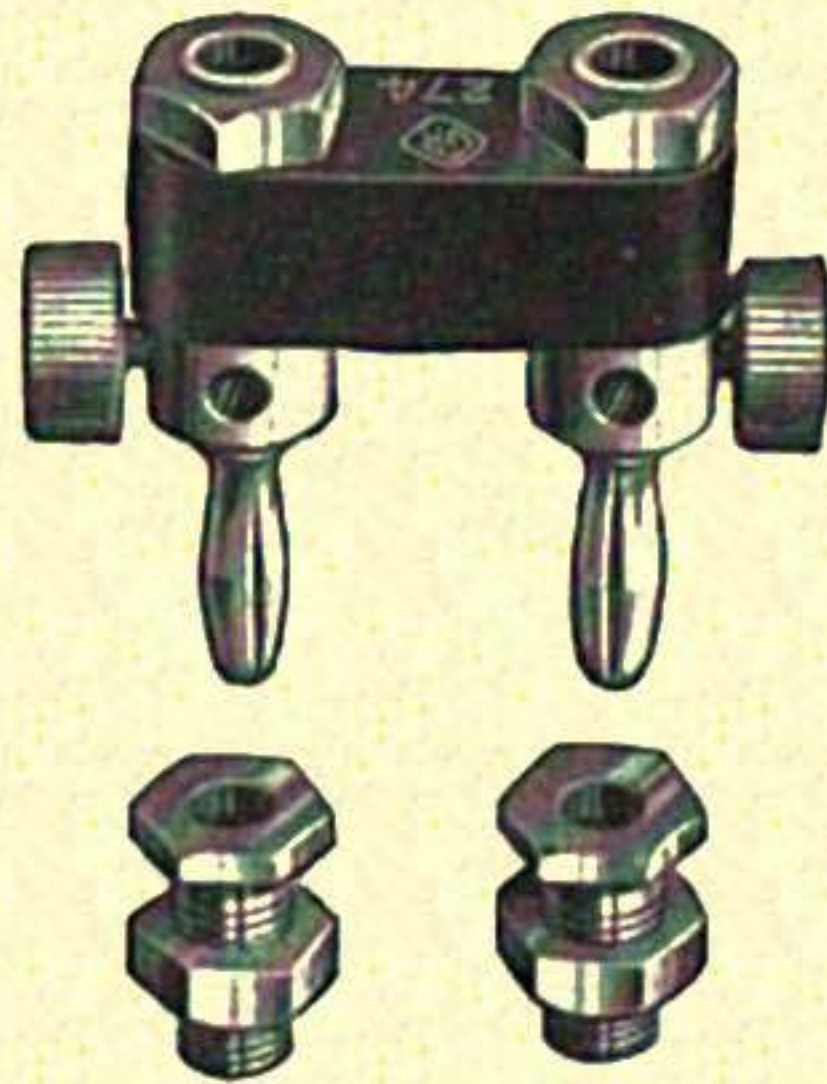

Fig. 213. General Radio Type 274 Plugs and Type 600 Jacks

This condenser is also useful in making measurements of very small capacitances, such as are possible with Type 216 Capacity Bridge.

ANTENNAE AMMETER

(Thermo-Couple Type)—Model 401

Dimensions

	Metal Case	Bakelite Case
Diameter of Case	4 $\frac{3}{8}$ "	4 $\frac{3}{8}$ "
Length of Scale	2.7"	2.7"

The only accurate and reliable means of measuring currents of radio frequency such as are present in the antennae of a transmitting set. Indications are not influenced by changes in room temperature, nor does the accuracy change due to use.

SMALL RADIO INSTRUMENTS

Direct Current—Model 301

Dimensions

	Metal Case	Bakelite Case
Case Diameter	3.25"	3.375"
Scale Length	2.35"	2.35"

These instruments, distinguished for their exquisite workmanship and permanently dependable performance, with the highest possible order of accuracy for instruments of their size. They are of the permanent magnet, double pivoted movable coil type. The movable system rotates on polished steel pivots in sapphire jewel bearings. The instruments are carried in stock in dull black cases and can be supplied for flush or surface mounting.

COMPLETE TRANSMITTING GROUP

4 $\frac{3}{8}$ Inches in Diameter

Dimensions

	Metal Case	Bakelite Case
Diameter of Case	4 $\frac{3}{8}$ "	4 $\frac{3}{8}$ "
Length of Scale	2.7"	2.7"

These instruments are of movable iron type. The pivots are of hardened steel supported by sapphire jewels. Accurate within 1% of full scale deflection. Scale long and legible. The case is dull black and can be supplied for flush or surface mounting. When desired, Bakelite cases can be provided to maintain uniform appearance on panel.

SMALL RADIO FREQUENCY INSTRUMENTS

Thermo Couple Principle

Dimensions

	Metal Case	Bakelite Case
Flange Diameter	3.25"	3.375"
Scale Length	2.35"	2.35"

A type of instrument specially developed by Weston to perfectly solve the problem of measuring the antennae current. It eliminates all troubles encountered in hot wire types—has no zero shift and is thoroughly compensated against changes in temperature.

It is the adopted standard in commercial and governmental work and is a remarkable contribution to the art of Radio Telephony.

COMPLETE TRANSMITTING GROUP

4 3/8 Inches in Diameter

Dimensions

	Metal Case	Bakelite Case
Diameter of Case	4 3/8"	4 3/8"
Length of Scale	2.7"	2.7"

A complete group of electrical instruments for the measurements of D.C. and A.C. of commercial and Radio frequencies consisting of Models 431, 429, 401.

These instruments are especially recommended to those who want the best and are willing to pay the slight additional cost involved.

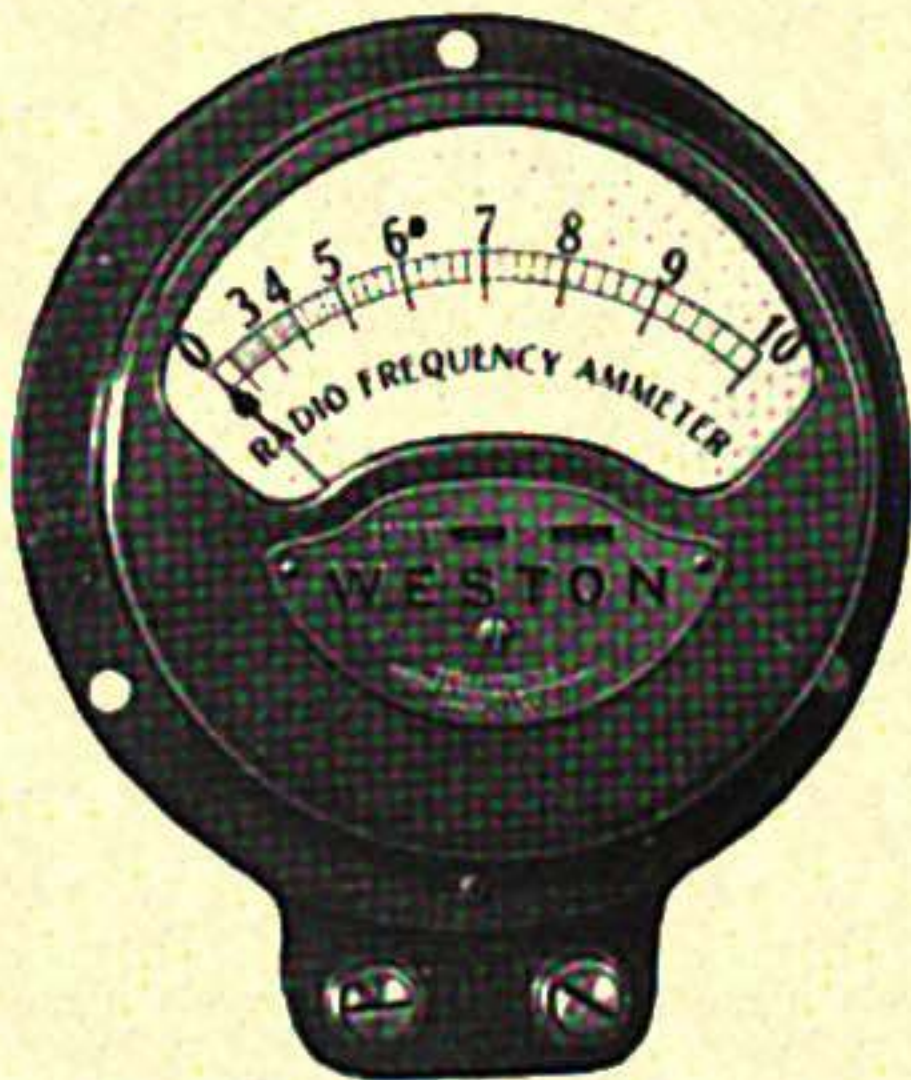

Fig. 214. Weston Type 401 Antenna Ammeter

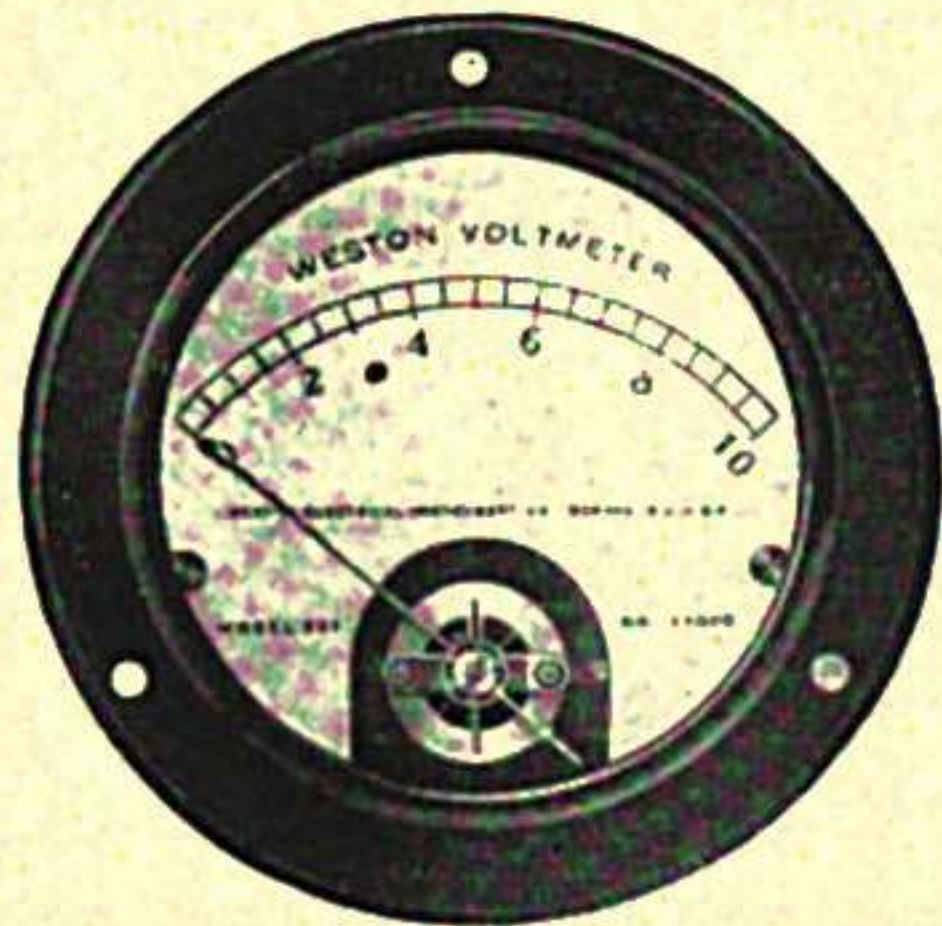

Fig. 215. Weston Model 301 0-10 Voltmeter

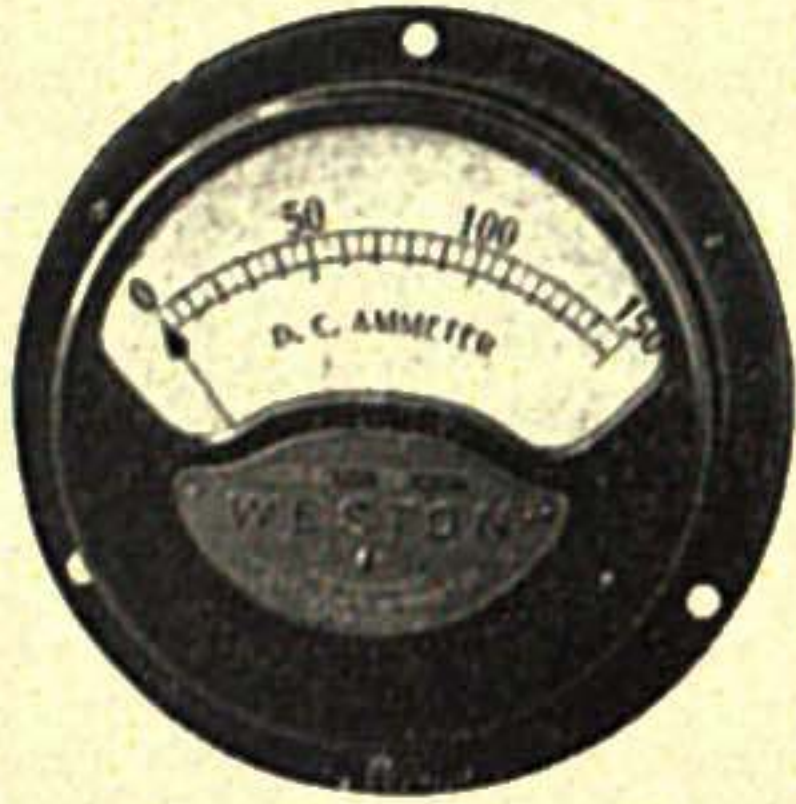

Fig. 216. Weston 0-150 Amps.
D. C. Ammeter

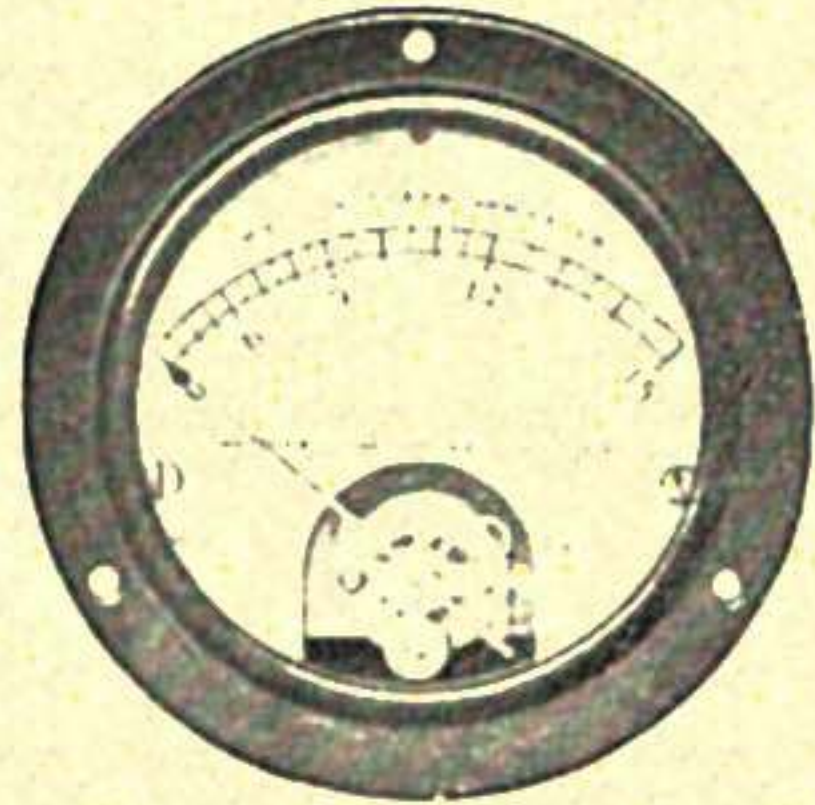

Fig. 217. Weston Model 301
Thermo-Couple Type



Fig. 218. Weston Model 440 Galvanometer

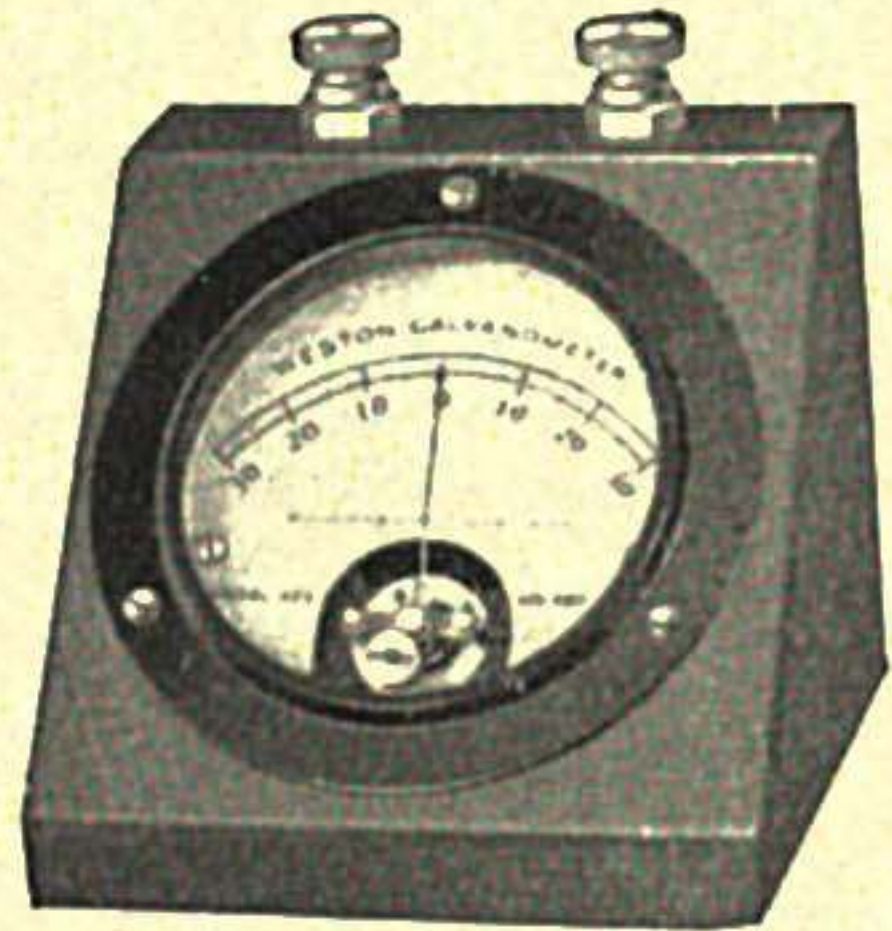

Fig. 219. Weston Model 375 Galvanometer

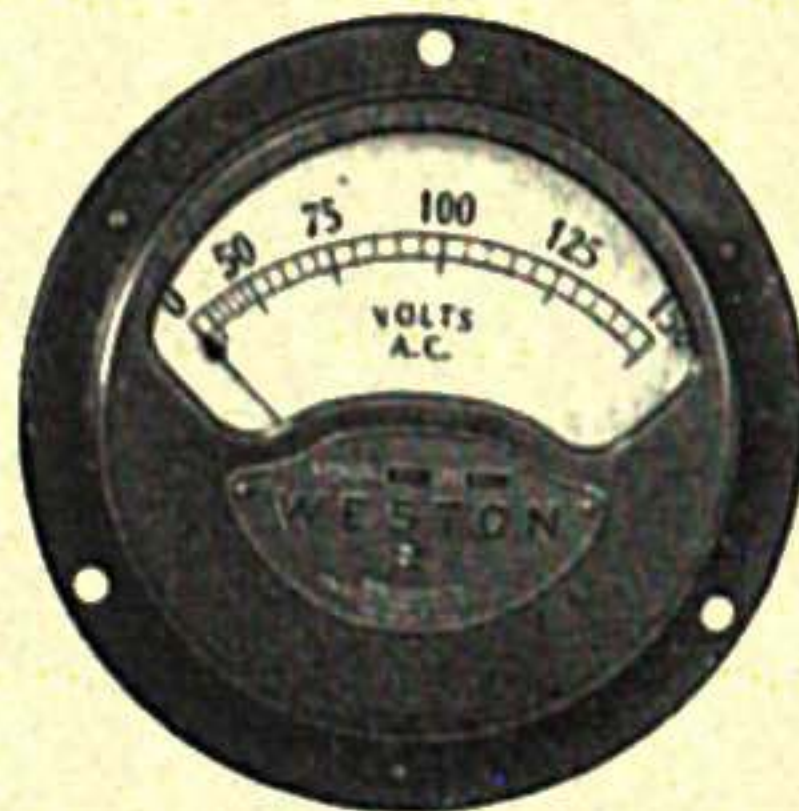

Fig. 220. Weston 0-150 Volts
A. C. Voltmeter

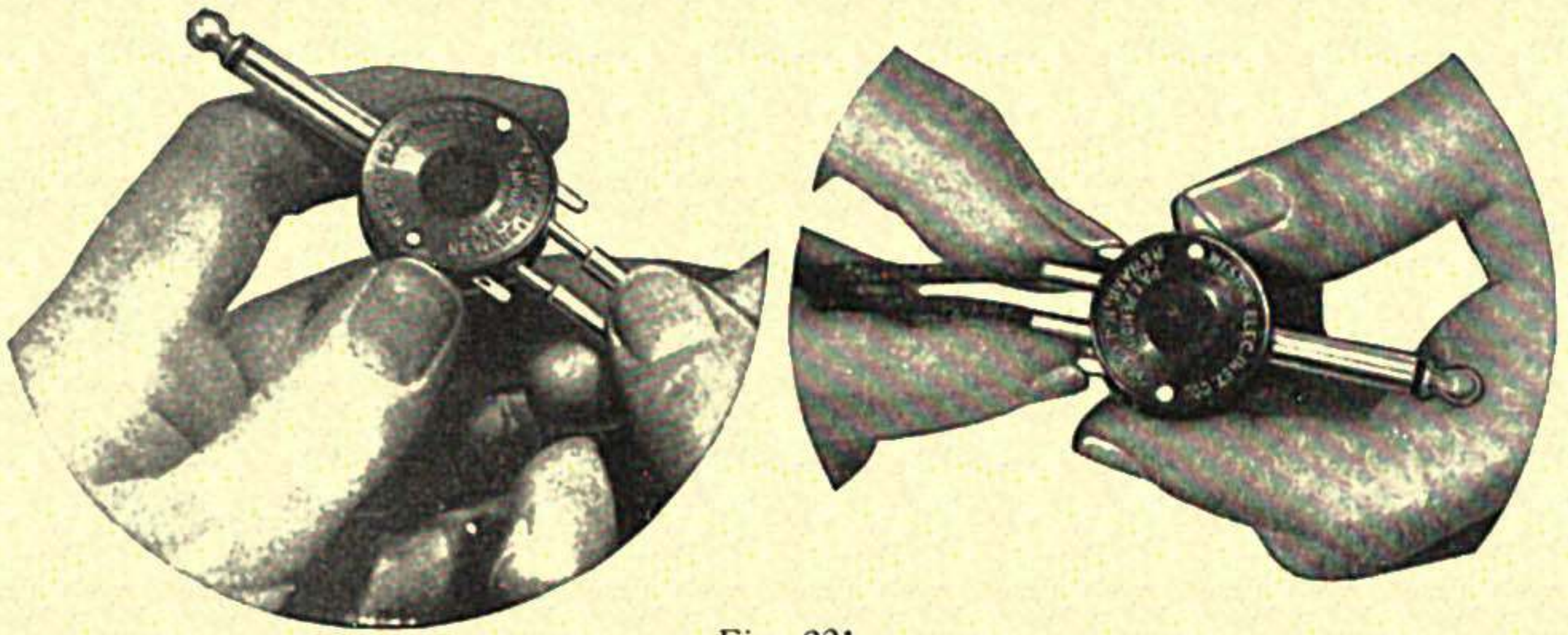

Fig. 221
Weston Radio Plug

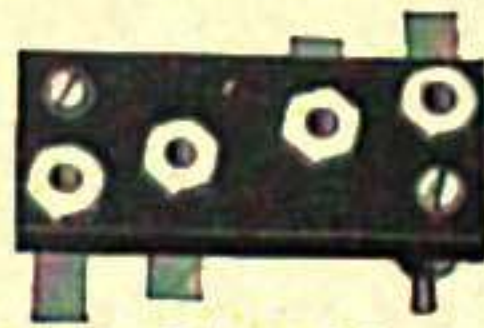

Fig. 222
General Radio Coils



Fig. 223. General Radio Type 139A
Switch

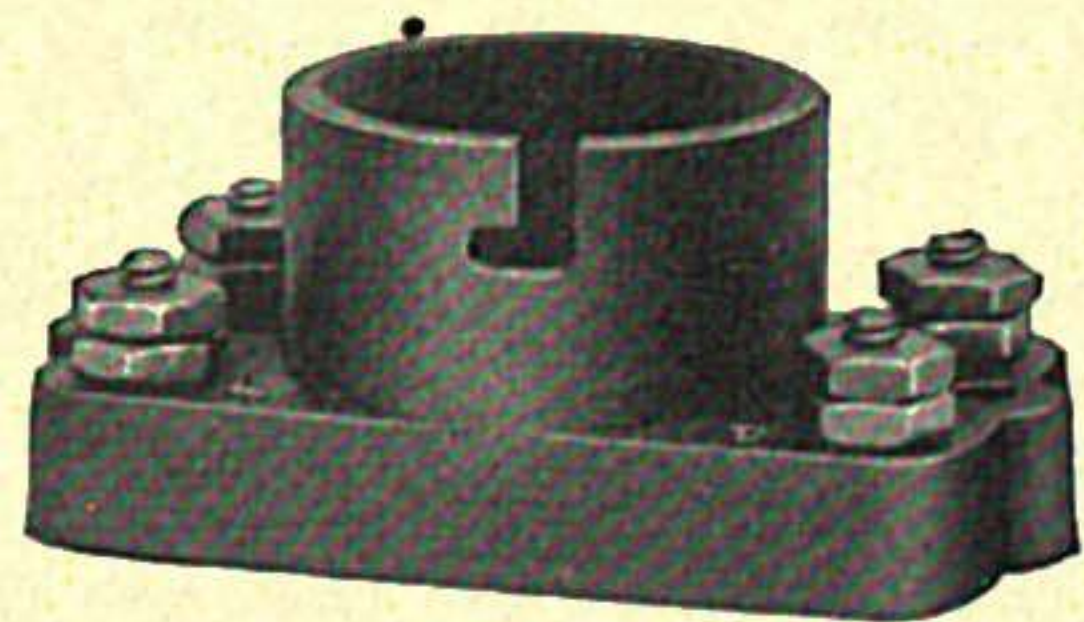

Fig. 224. General Radio Type 299
Socket for UV199 Tube

THE WESTON RADIO PLUG

To release hold the Plug as shown in Fig. 221. Push in the projecting metal tongues and at the same time pull out the leads. To fasten, push the phone lead tips into the openings of the plug as shown. Positive contact is instantly obtained. Nothing to unscrew or put together. Takes but a moment. Requires only a pressure of the fingers.

Model 489**DOUBLE RANGE TESTING VOLTMETER**

Size— $2\frac{7}{8}$ inches wide. $3\frac{1}{8}$ inches high. $1\frac{7}{8}$ inches deep

Range—0 to 7.5 and 0 to 150 volts.

Multiplier—None required.

Case—Moulded Bakelite.

Type—Combination portable and switchboard.

The heart of the radio receiving set is the tube.

The quality and intensity of reproduction can be made perfect only if the tube is operating under correct filament and plate voltage. This cannot be sensed. It must be measured by means of a voltmeter designed for the purpose.

Tubes last longest when operated at their rated voltage. Here again a dependable voltmeter is indispensable.

In selecting a voltmeter for radio use certain fundamentals must be borne in mind.

First, the voltmeter must be designed to maintain its accuracy and dependability. Then, it must read equally well on the low filament voltage and the high-plate voltage. The use of the double range eliminates the necessity for having two instruments.

For a true reading the resistance of the voltmeter must be as high as possible.

WESTON PORTABLE STUDENT GALVANOMETERS**Model 375**

The Weston Model 375 Galvanometer has been specially designed to meet the demand for a portable galvanometer of great durability, reasonable sensitivity and moderate cost.

The Model 375 Galvanometer possesses the same general characteristics as do the more expensive portable galvanometers, Models 14 and 15, except that it has not the same order of sensitivity.

The resistance of the Model 375 Galvanometer is approximately 25 ohms. The current required for a millimeter (one scale division) deflection is 22 microamperes.

With 1 volt, a deflection of 1 millimeter will be obtained through 45,500 ohms, but as a deflection of 0.2 of a millimeter can be readily detected, the galvanometer is, in reality, serviceable through 227,500 ohms.

The instrument is mounted on a handsome base so that the face, or scale, is inclined at an angle of 45 degrees. The finish is dull black japan.

The scale has 60 divisions and is calibrated 30-0-30.

Each instrument is provided with a zero-adjusting device.

This galvanometer is recommended for the use of students in colleges and schools, for making bridge measurements, and for the detection of small currents.

WESTON MODEL 440 GALVANOMETER

This super-sensitive permanent magnet, double pivoted, movable coil galvanometer has been developed to provide an instrument which will, for most purposes, replace the delicate suspended coil reflecting galvanometer.

It is made in two types, namely:

1. Portable type for general use where the galvanometer is not an integral part of test circuit.

This type is provided with two contact keys, controlled by push buttons located one on each side of the scale in the instrument case. The first key closes the galvanometer circuit through a high resistance to prevent damage to the movable system in case the circuits under test are considerably out of balance. The second key closes the galvanometer circuit directly so as to obtain maximum sensitivity.

2. Flush type when the galvanometer is to be used as an integral part of unit sets such as potentiometers, bridges, etc.

Both of these types are inclosed in a dust proof dull black finish case. A mechanical device is also provided by means of which errors in the zero position can be corrected.

The following three ranges are available, each is designed for a particular purpose, so as to assure satisfactory results.

FOR INSULATION OR OTHER HIGH RESISTANCE TESTING

Microamperes Per Division	External Critical Resistance in Ohms	Resistance of Movable Coil in Ohms	Period in Seconds	Code Word
0.25	1,000	150	2.7	Galvani

This range is very sensitive to small currents and has a comparatively high critical damping resistance.

FOR USE WITH LOW RESISTANCE POTENTIOMETERS FOR THERMO-COUPLE WORK AND ALL LOW RESISTANCE CIRCUIT TESTING

Microamperes Per Division	External Critical Resistance in Ohms	Resistance of Movable Coil in Ohms	Period in Seconds	Code Word
2.2	10	3.5	2.3	Galvic

This range has a very high sensitivity for small differences of potential and has a correspondingly low critical damping resistance.

FOR AVERAGE WHEATSTONE BRIDGE MEASUREMENTS

Microamperes Per Division	External Critical Resistance in Ohms	Resistance of Movable Coil in Ohms	Period in Seconds	Code Word
0.5	150	50	2.5	Galvo

This range has intermediate values of constants and is especially designed for average wheatstone bridge work.

Dimensions

Surface Type	6 $\frac{3}{4}$ " length, 4 $\frac{1}{4}$ " width, 2 $\frac{3}{8}$ " height
Flush Type	6 $\frac{1}{4}$ " length, 4 $\frac{1}{2}$ " width, 2 $\frac{7}{8}$ " height

Scale

The scale has a length of thirty millimeters, in millimeter divisions, each side of zero. The instruments are provided with a mirror and a knife edge pointer to eliminate parallax and facilitate readings.

Responsiveness

When critically damped, the motion of the movable system is very responsive to changes in current, as it then has a short natural period.

Selection

Care should be exercised in choosing a galvanometer having characteristics most suitable for the desired tests as the most satisfactory results are obtained when the damping of the movable system is such that its motion is nearly critically aperiodic or deadbeat.

Critical damping results when the resistance of the test circuit connected across the galvanometer is equivalent to the value of the external critical resistance given in the above table; therefore, a range should be chosen which has a critical resistance of the same order as the resistance of the circuit in which the galvanometer is connected.

If a galvanometer having a high critical resistance is used in a low resistance circuit, the motion of the pointer will be very sluggish and will require an undesirably long time to come to rest.

Damping

The movable coils of these instruments are not wound on metallic frames to damp their motion as is the case with ordinary forms of direct current indicating instruments, because the circuits into which the galvanometer is connected generally provides the requisite damping by the generator action of the movable coil, and any inherent damping would cause sluggishness.

If at any time the galvanometers are used in high resistance circuits and better damping is desired, it is only necessary to connect a high resistance across the binding posts of the instrument equal to or greater than the critical resistance of the instrument.



Storage "B" Battery, 48 Volts—5 Amp. Hours.



Storage "A" Battery, 6 Volts—80 Amp. Hours.

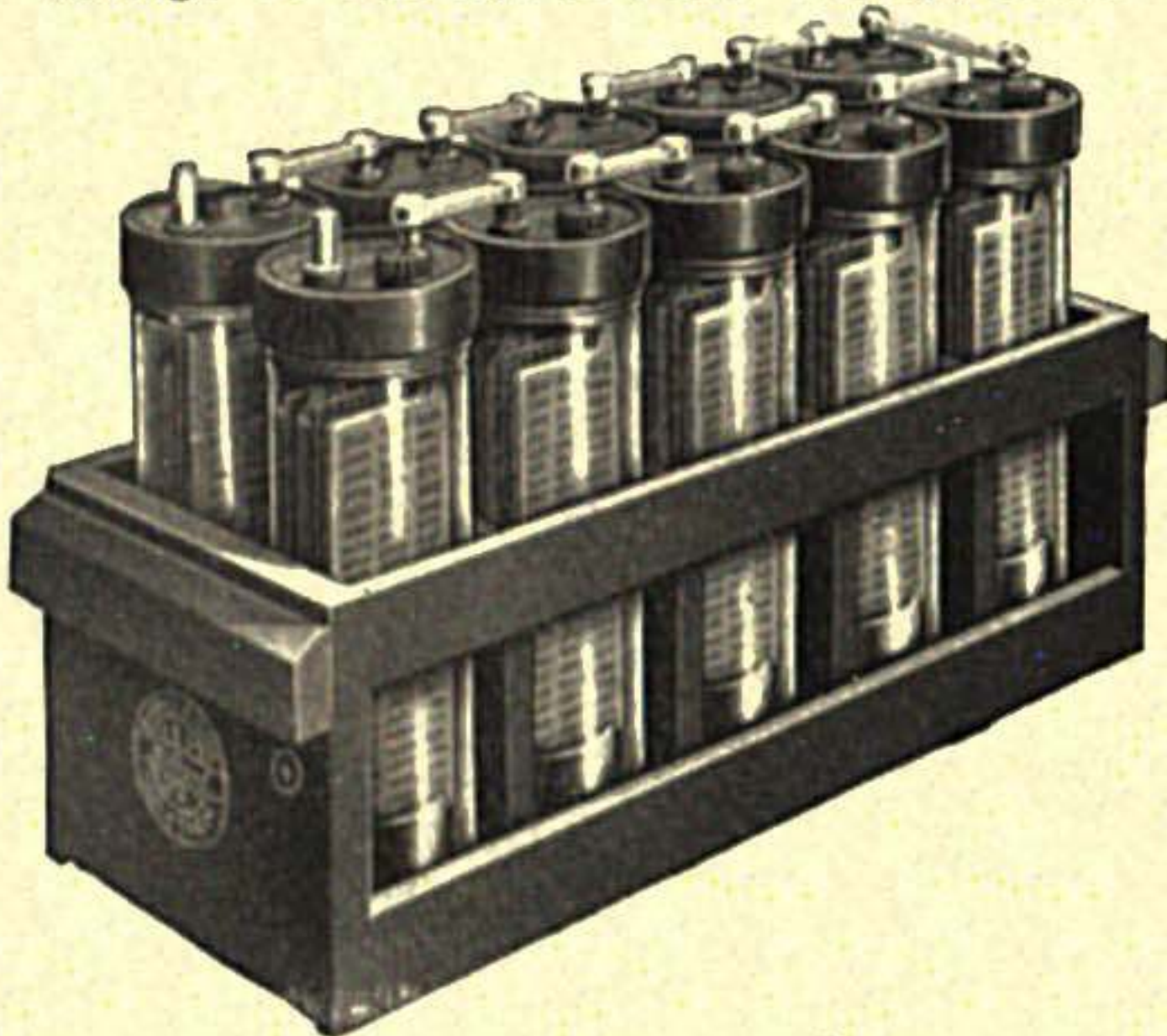

Storage "B" Battery, 48 Volts—15 Amp. Hours.



Storage "A" Battery, 6 Volts—100 Amp. Hours.



Storage "B" Battery, 48 Volts—2½ Amp. Hours.



Rectifier.

Fig. 225

Willard Battery Products

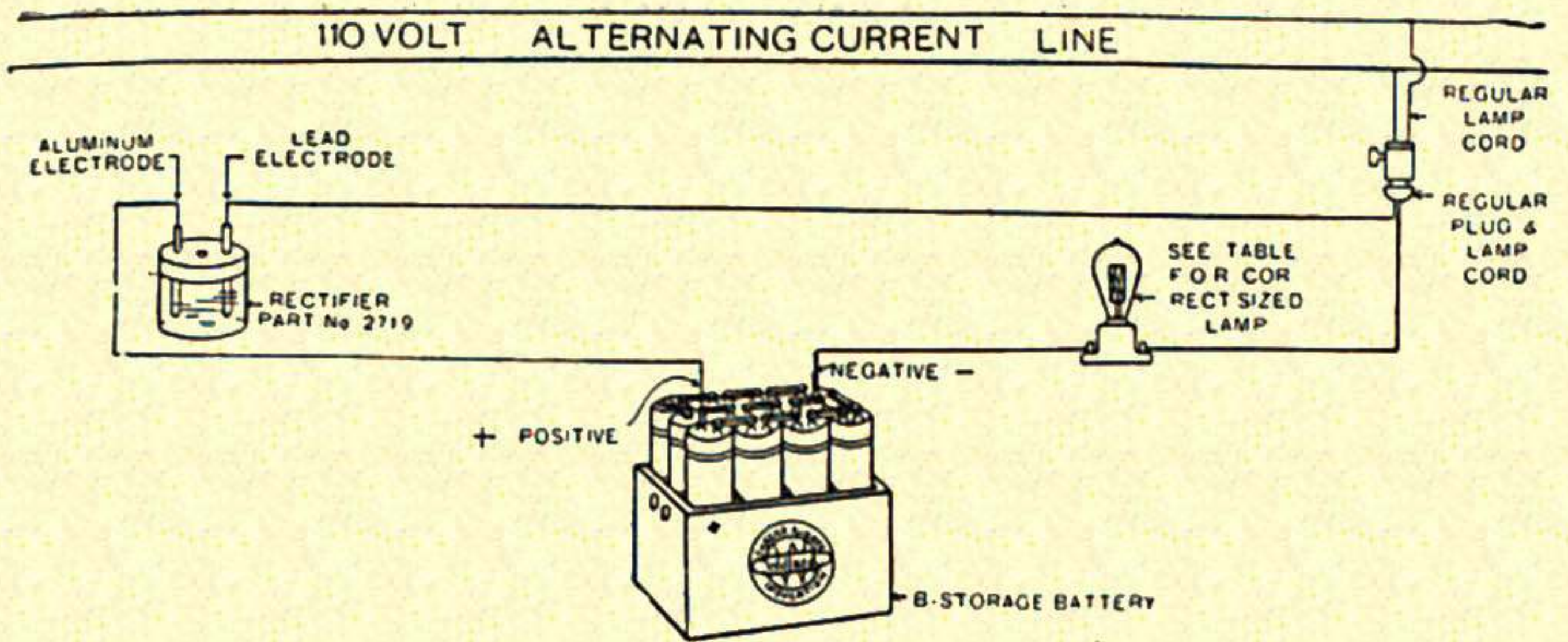

Connections for Charging Storage "B" Batteries with Willard Rectifier

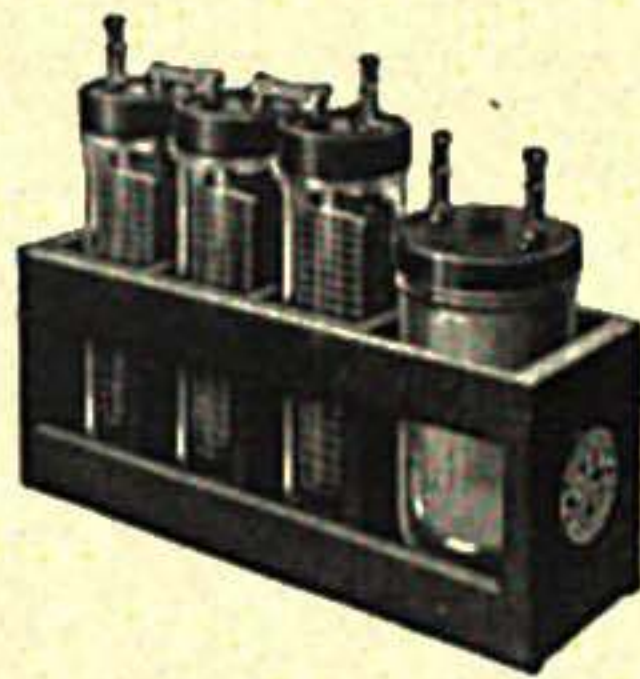

6 Volt, 15 Amp. Hour, with Rectifier



24 Volts, 5 Amp. Hour



24 Volts, 2½ Amp. Hour

Fig. 226
Willard Storage "B" Batteries



1 MF By Pass Condenser

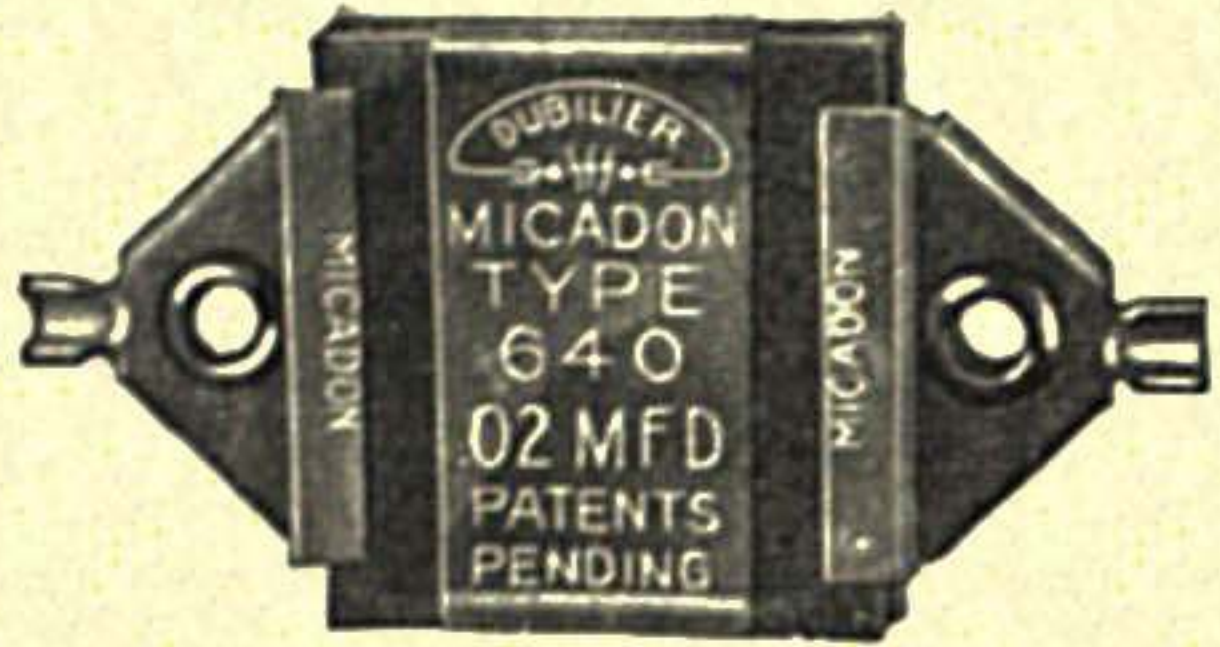

Type 640—.02 MF Condenser



Type 577—.001 MF Mica Condenser

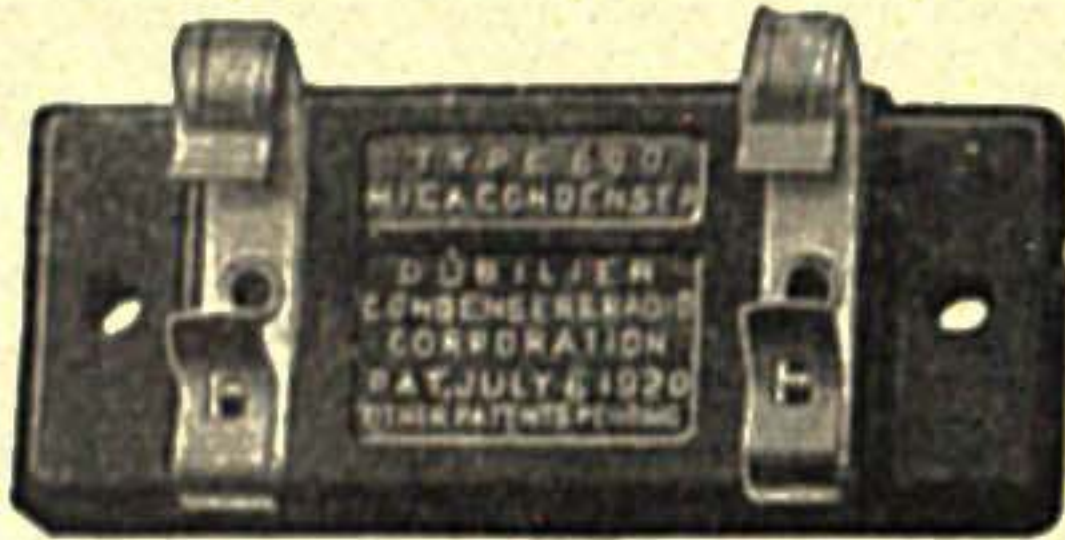

Type 600—Micadon with Grid Leak Clips

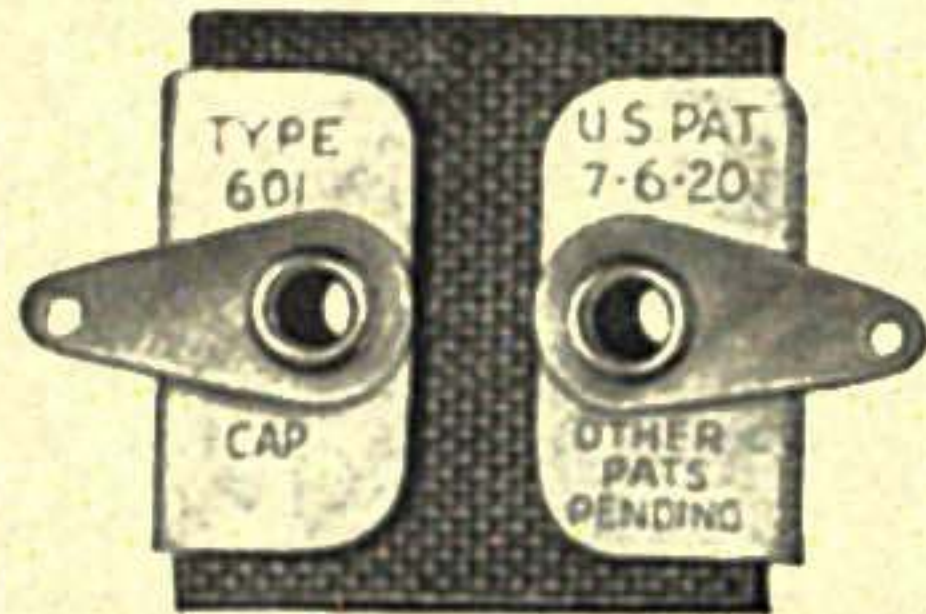

Type 601—Micadon Fixed Condenser



Type 560—Mica Cond.



Duratran Rad. Freq. Transformer

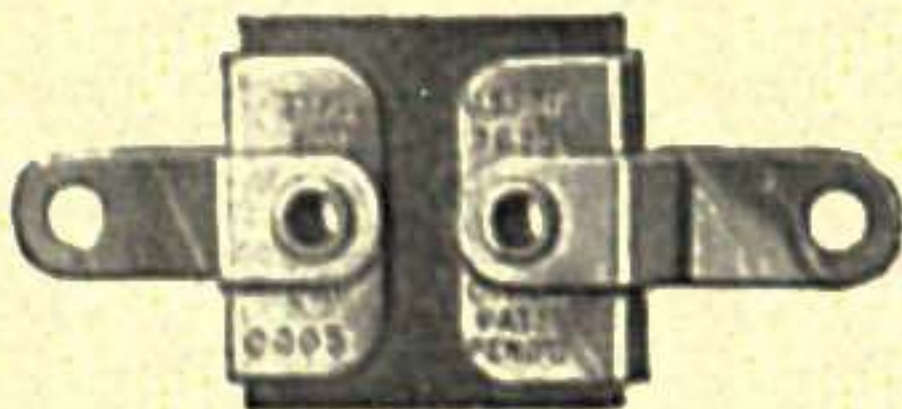
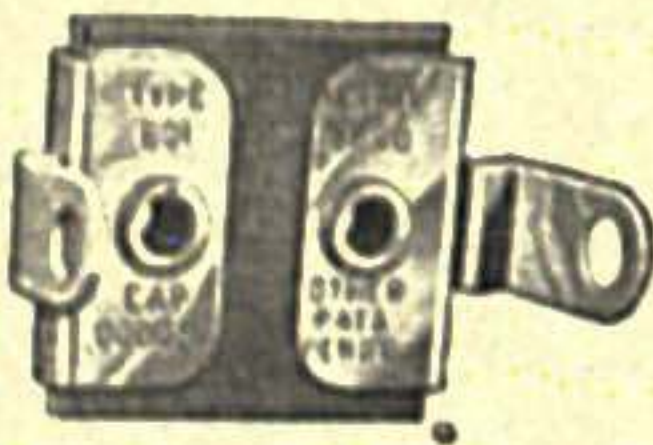

Type 601G—Micadon with Grid Leak Clips



Ducon—For Light Socket: Antenna

Fig. 227
Dubilier Products

CHAPTER VI
TRANSMITTING EQUIPMENT



Fig. 228
Broadcasting Studio Station KGO, Oakland, California



Fig. 229
Proposed Station General Electric Company, Denver, Colo.
277

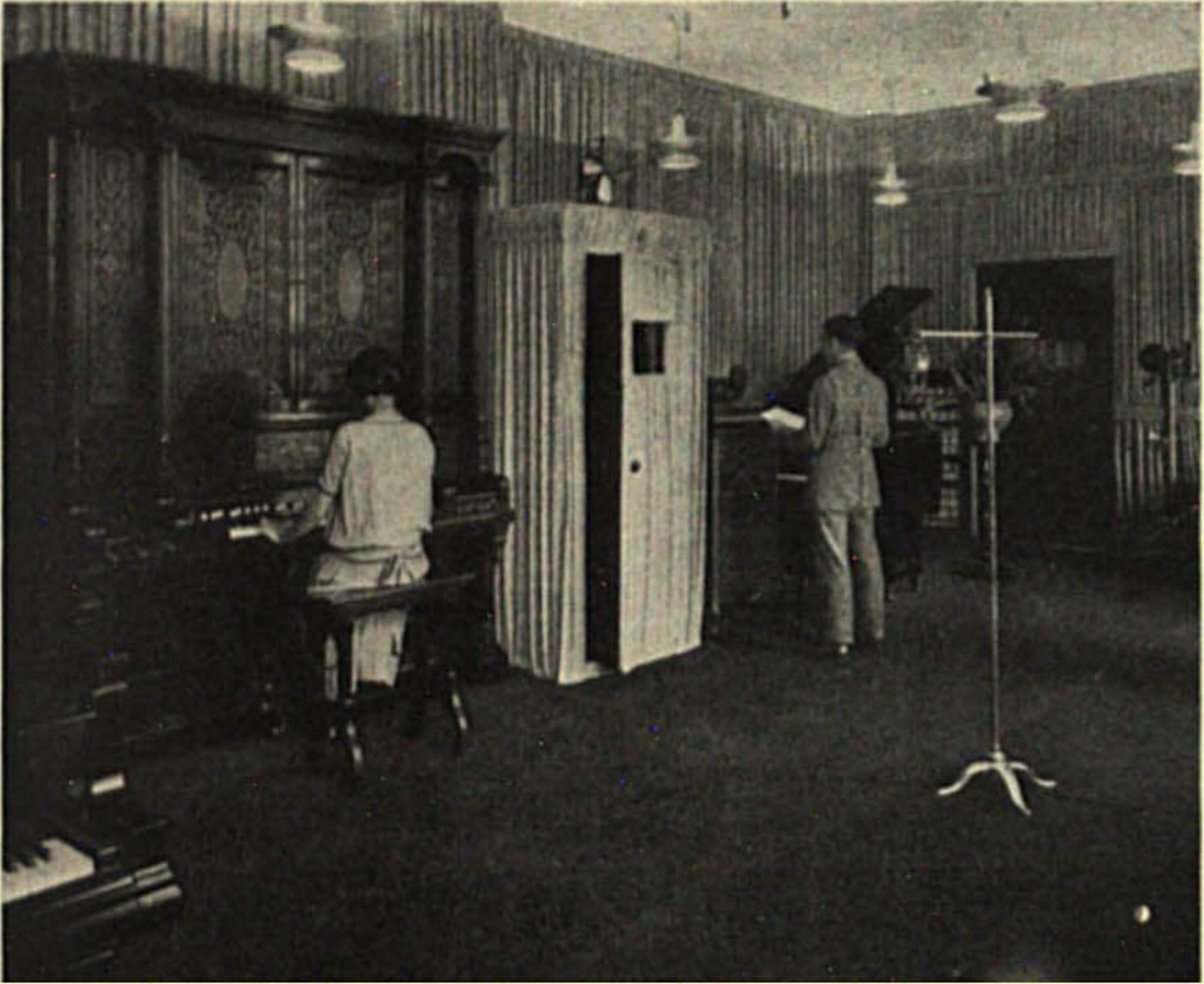

Fig. 230

Broadcasting Studio WGY, General Electric Company, Schenectady, N. Y.

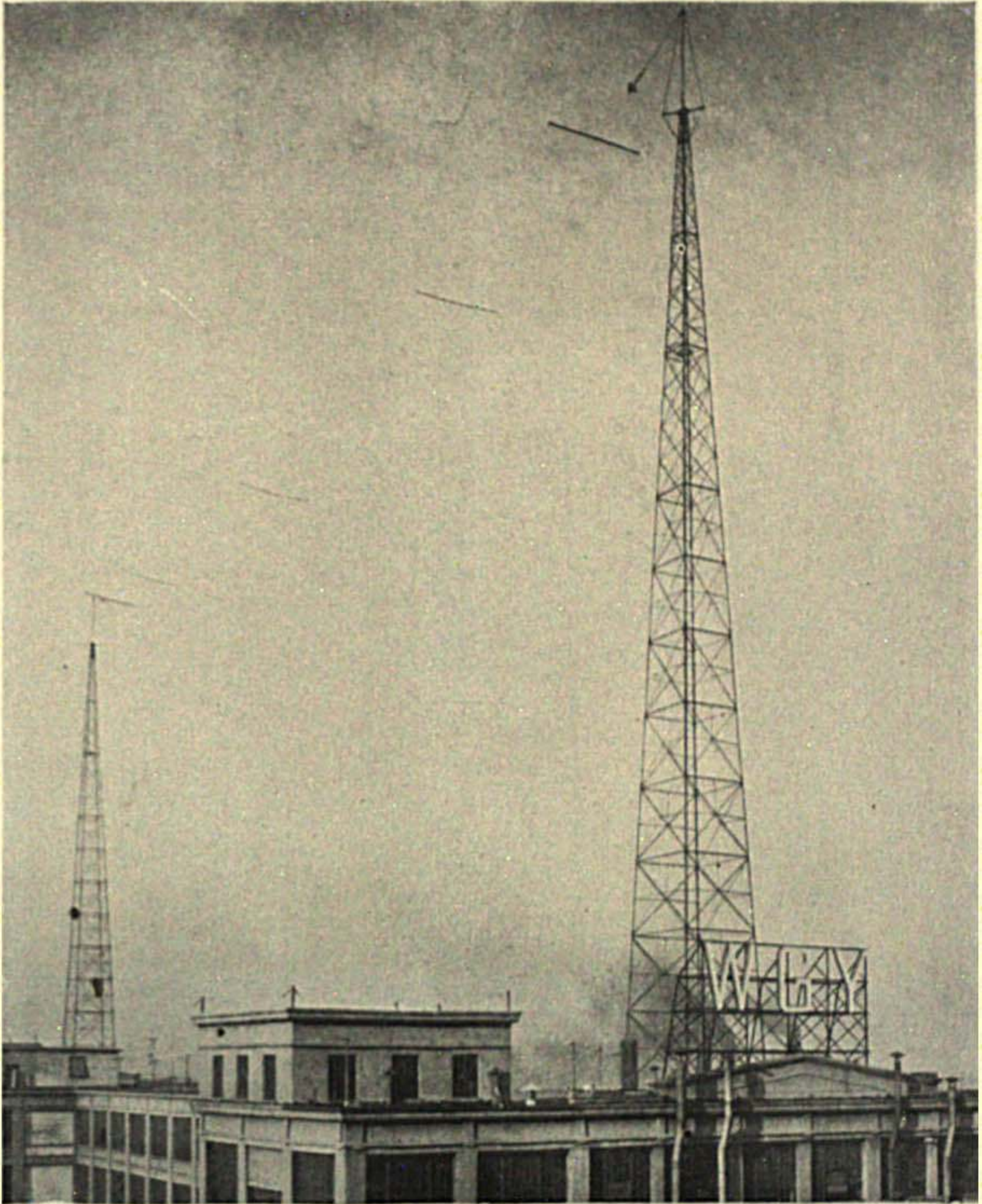

Fig. 231
Aerial System, General Electric Company, Schenectady, N. Y.

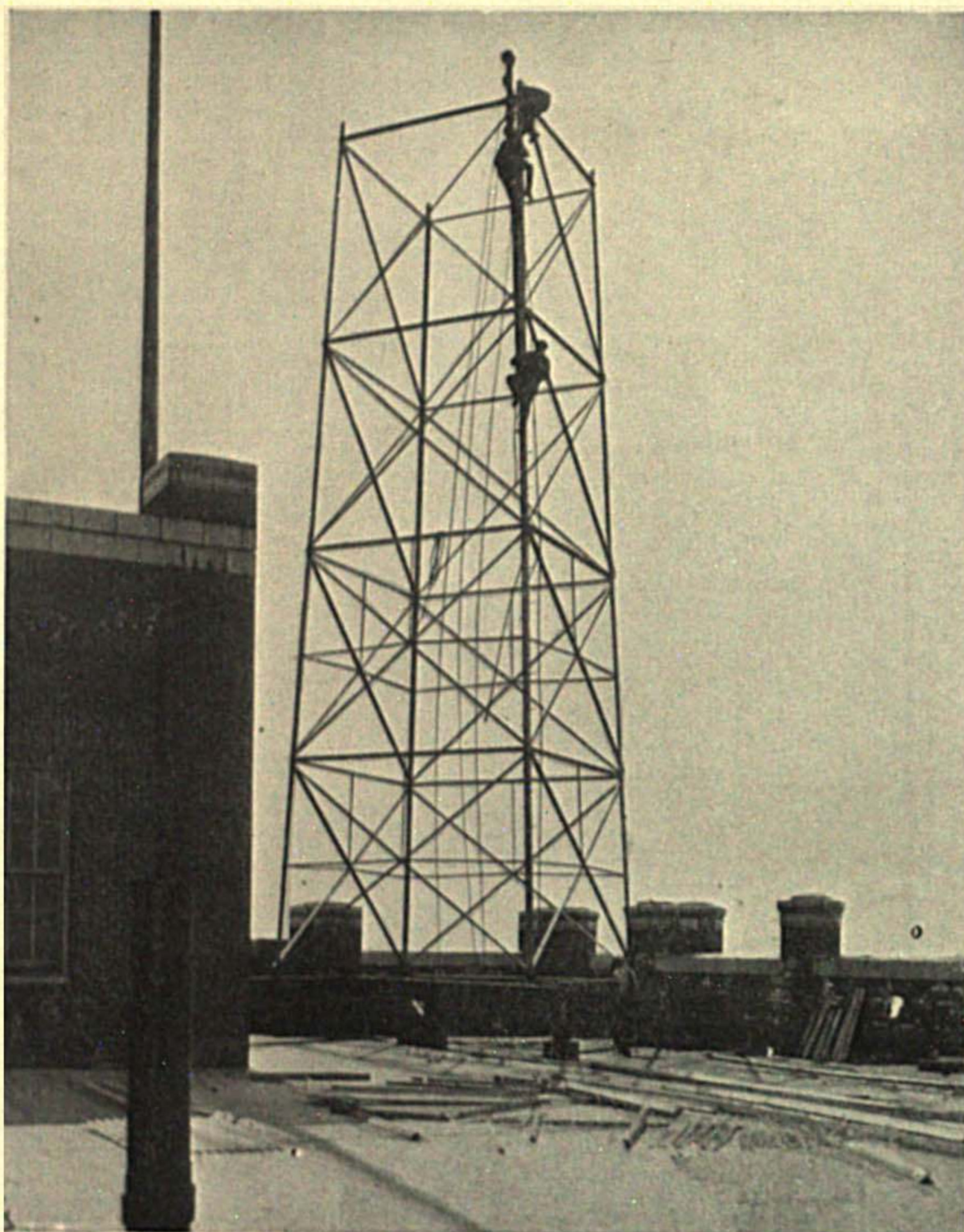

Fig. 232
Tower Erection, Station WEAFF, New York



Fig. 233

Completed Roof Tower, Station WEA, New York

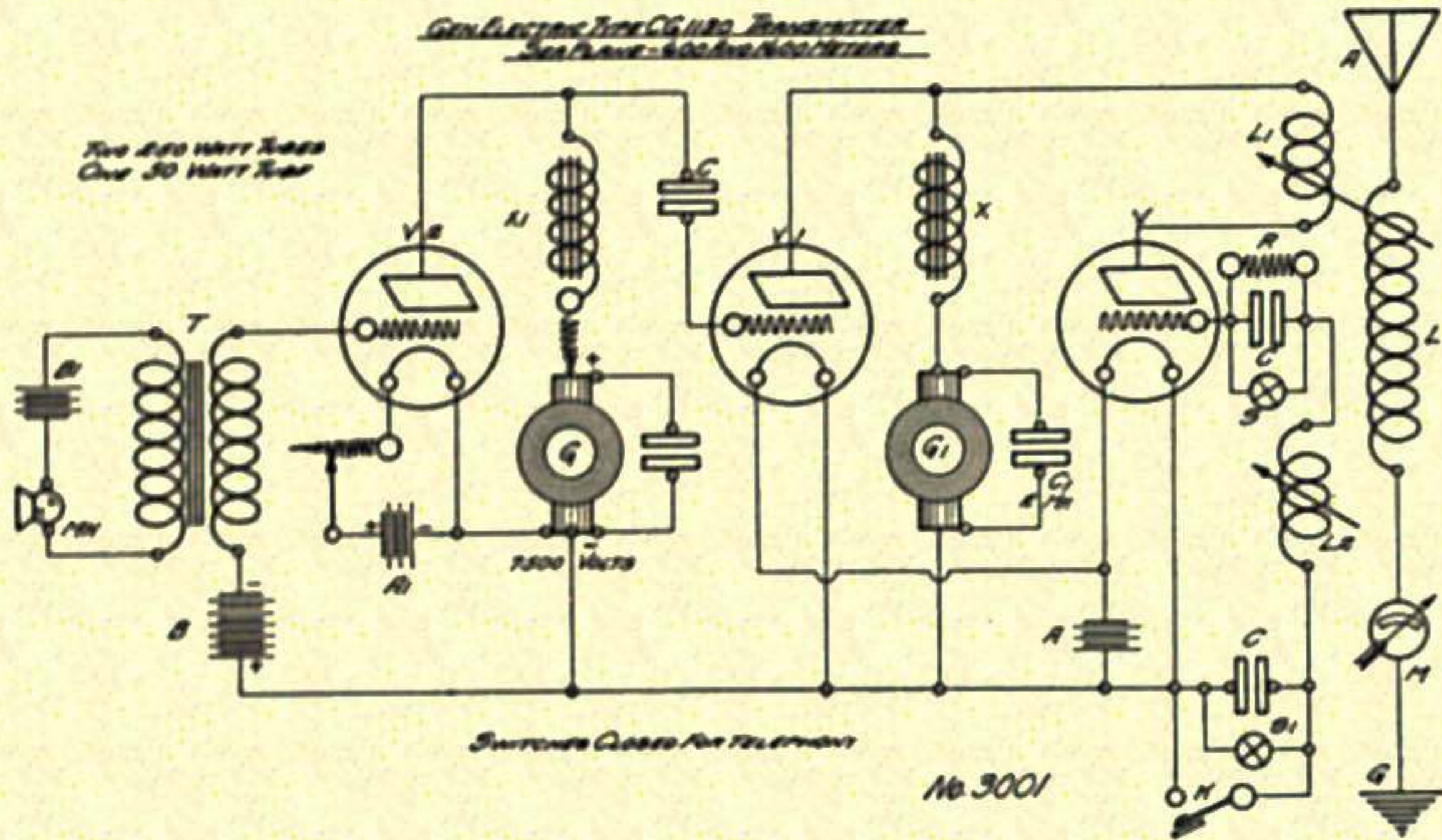

Fig. 234

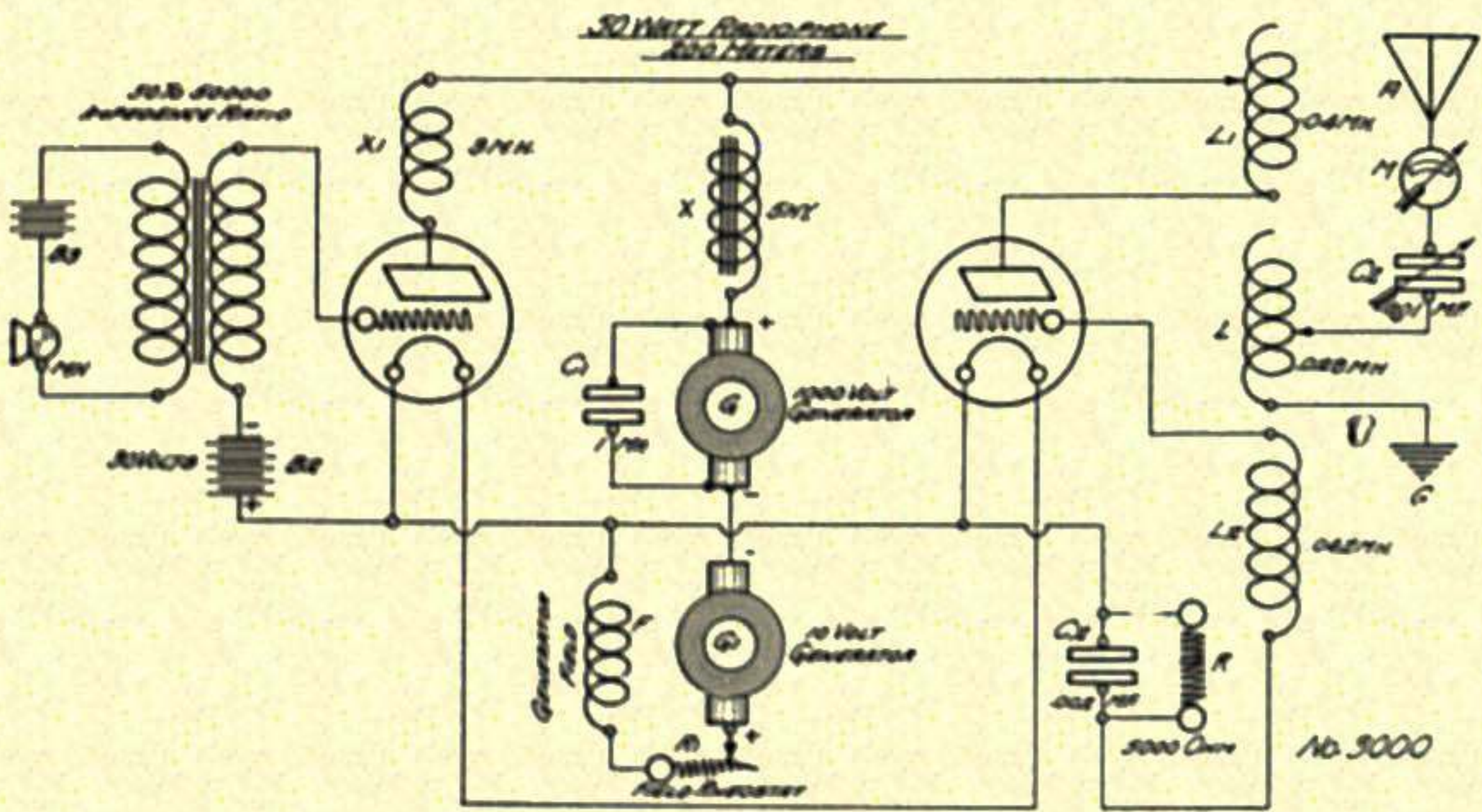

Fig. 235



Fig. 236
Studio Building, KGO, Oakland, Calif.



Fig. 237
Power Control Room, KGO, Oakland, Calif.

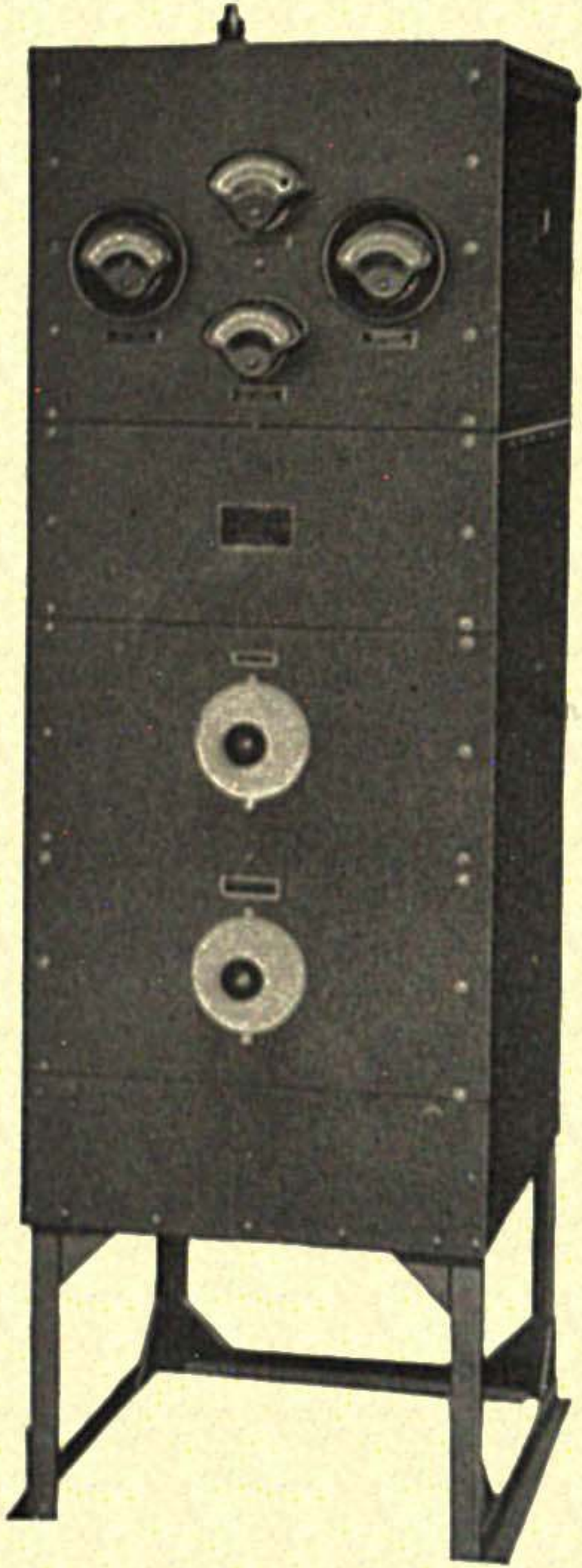

Fig. 238
Western Electric R. F. Panel

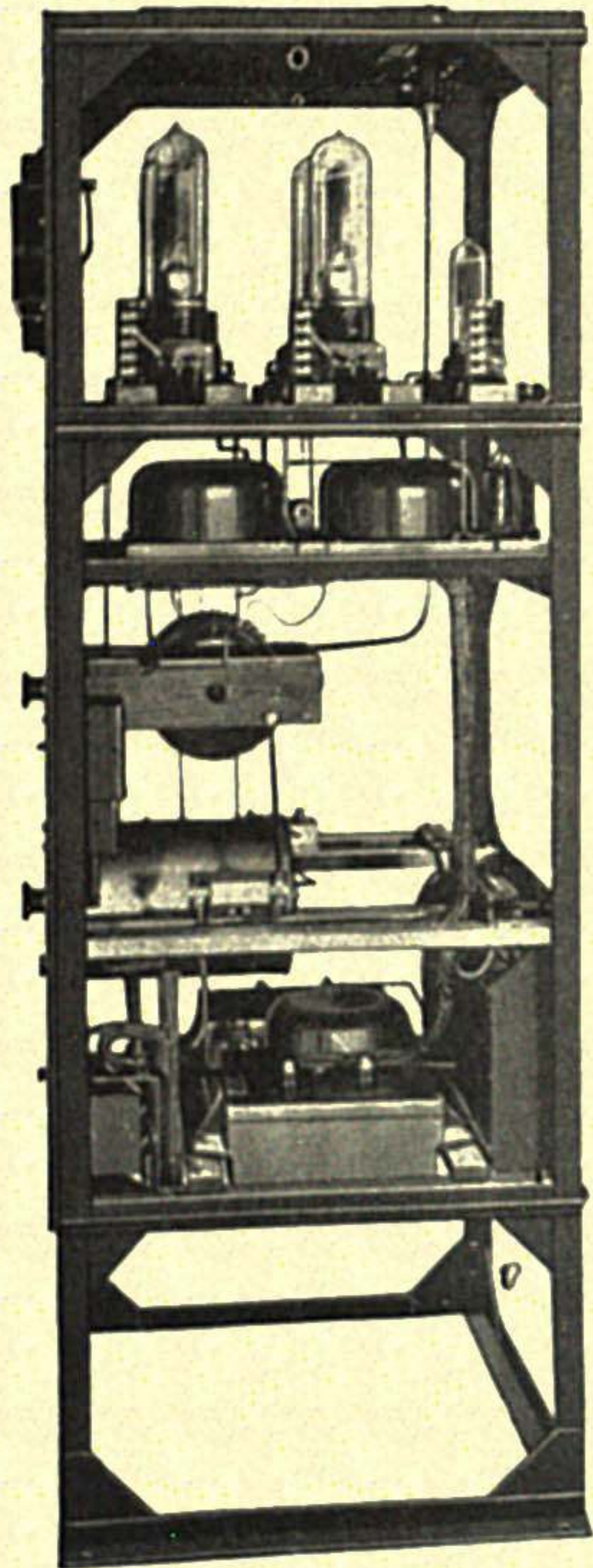

Fig. 239
Western Electric R. F. Panel, Side View

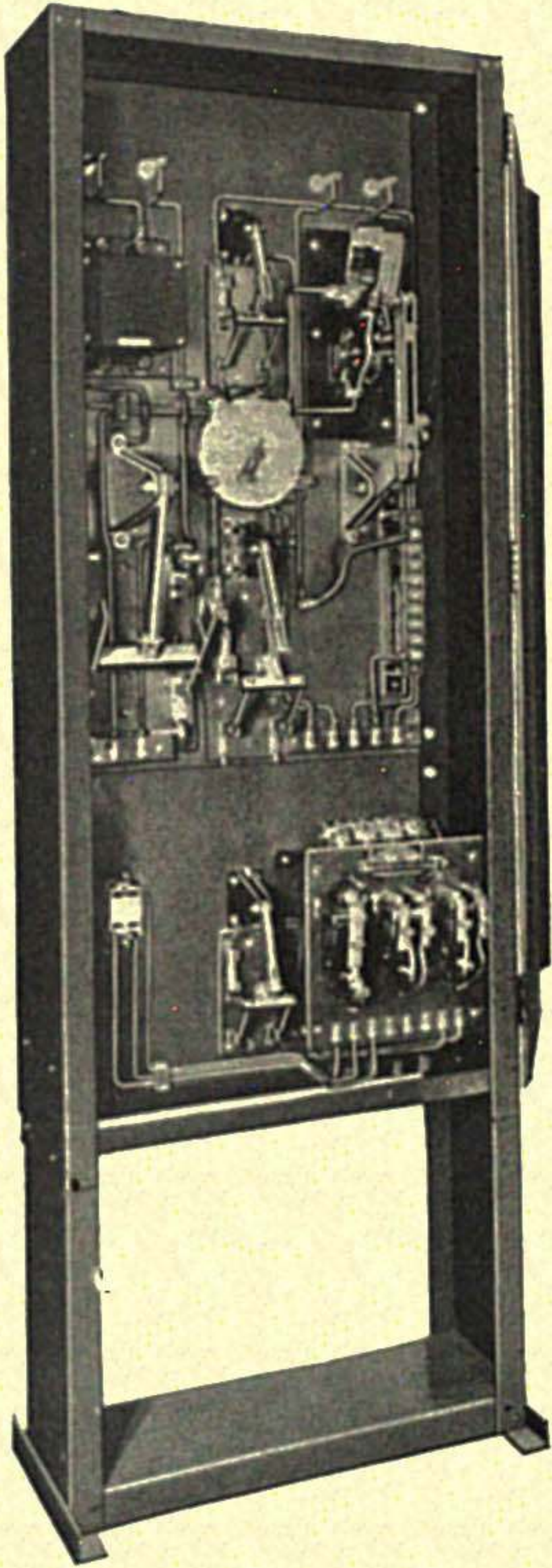

Fig. 240

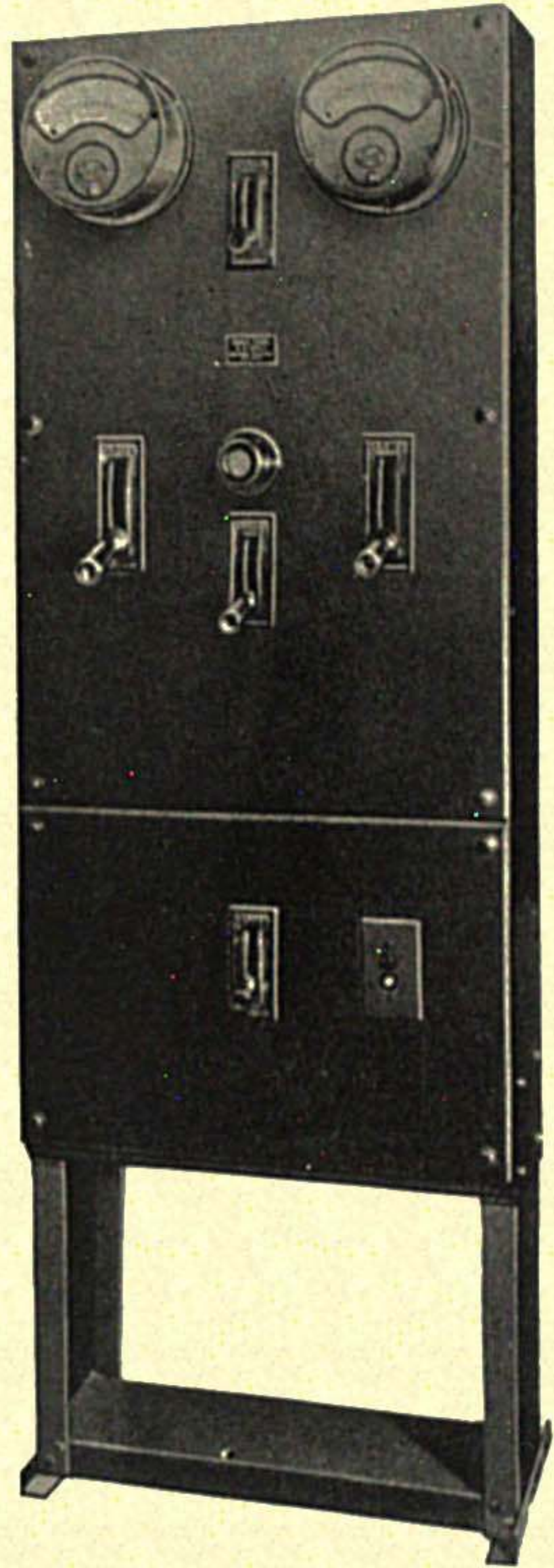

Fig. 241

Western Electric Power Panel, Rear View Western Electric Power Panel, Front View

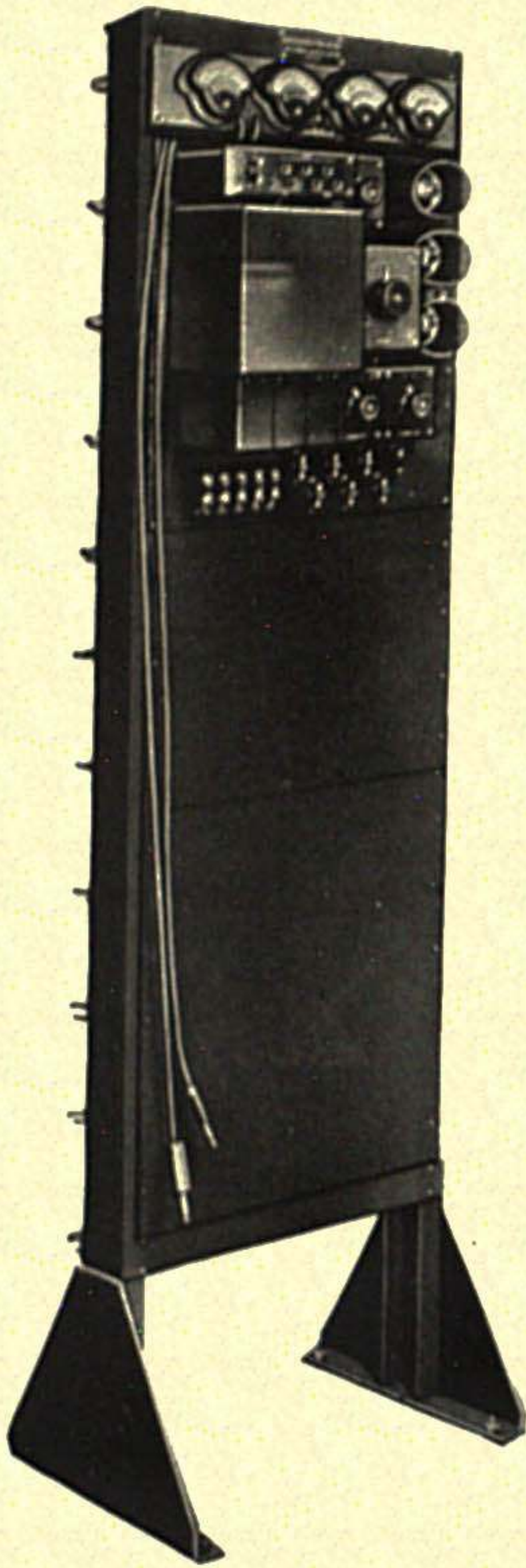

Fig. 242
Western Electric Amplifier Panel, Front
View



Fig. 243
Western Electric Microphone

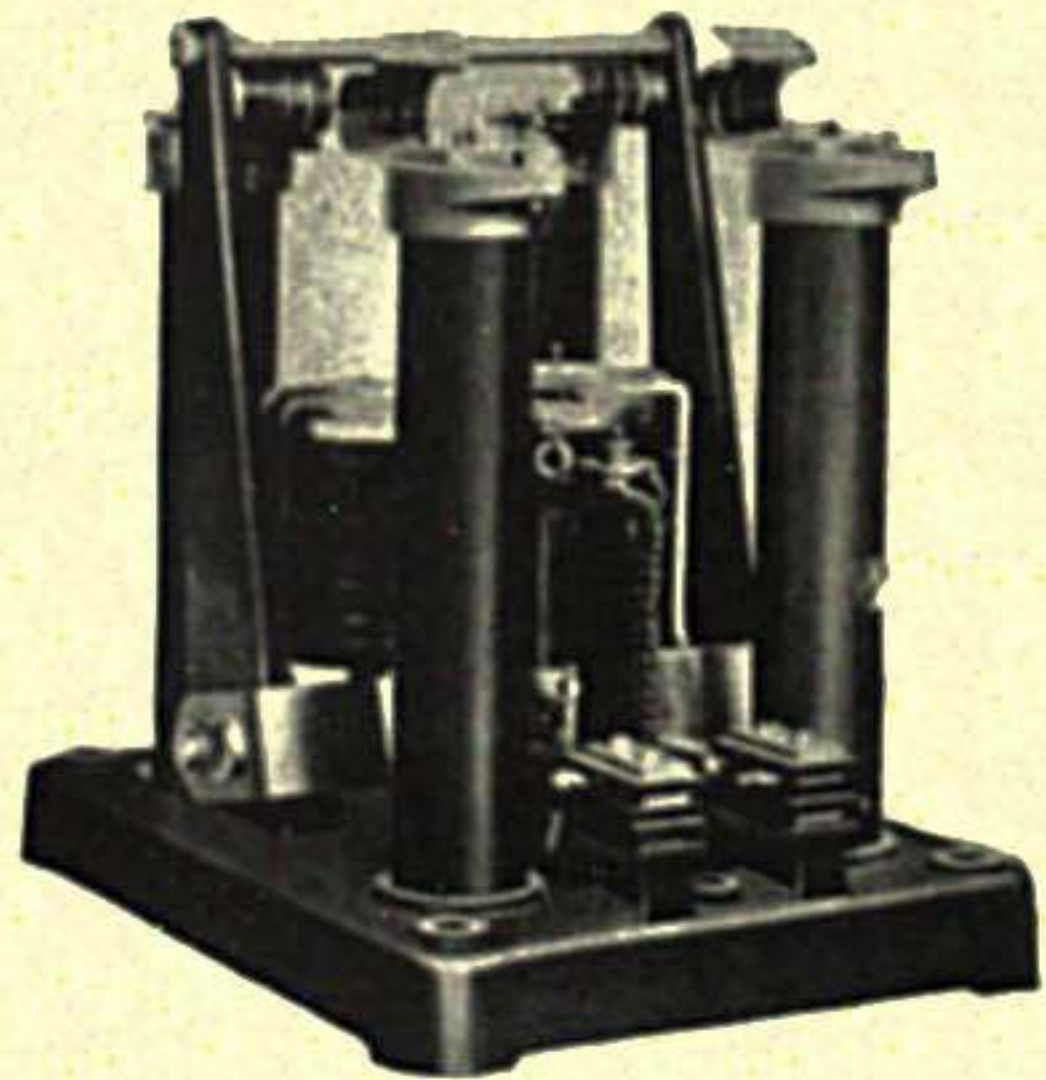

Fig. 244
Western Electric Send-Receive Switch

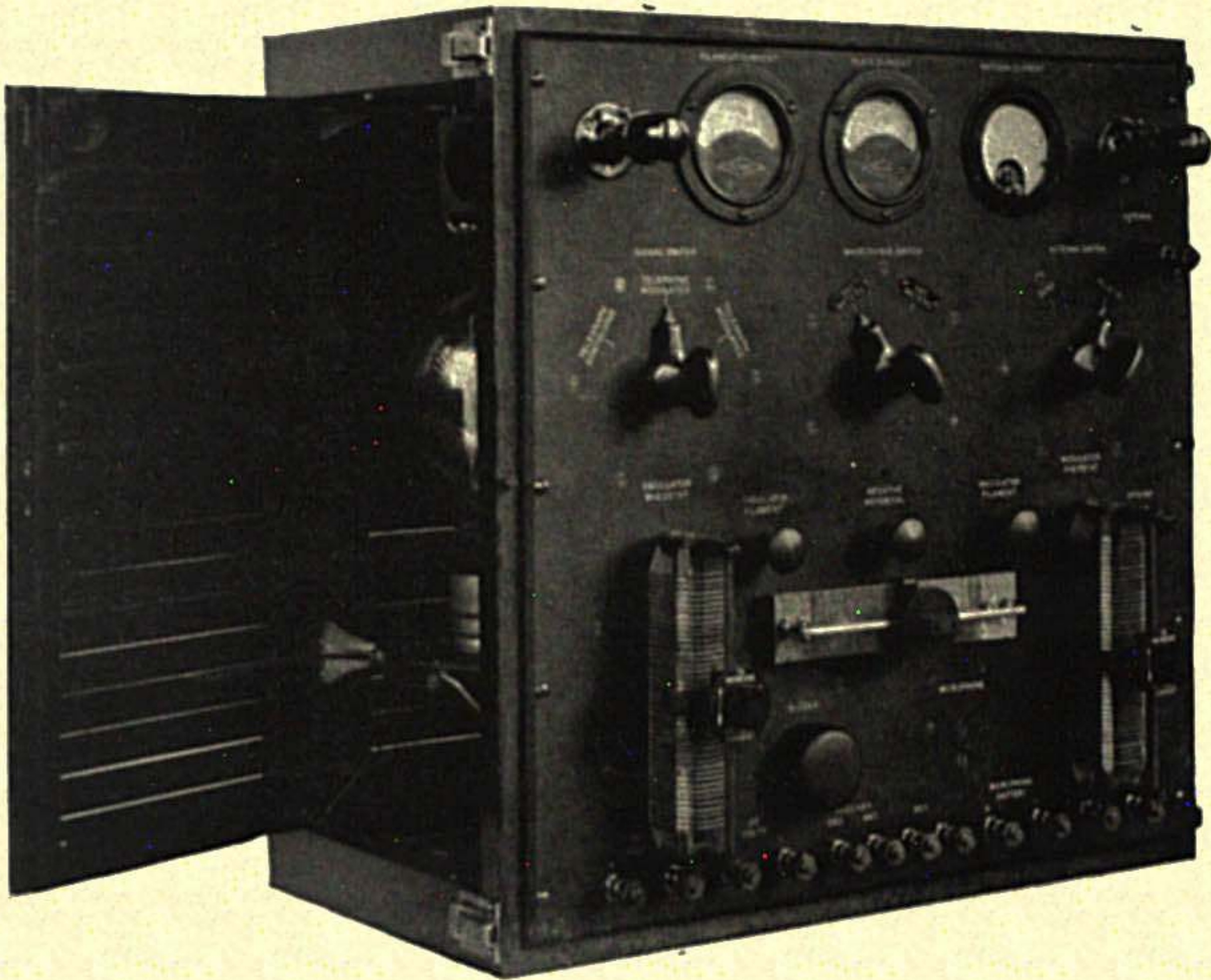

Fig. 245
100-Watt Radiophone for Inter-Fleet Work

SPECIFICATIONS

Radiotrons C-304

Filament Terminal Voltage.....	11 V.
Filament Supply Voltage.....	12 V.
Filament Current.....	14.75 Amp.
Plate Voltage.....	2,000 V. normal
Plate Current.....	.25 Amp.
Output Impedance.....	6,000 ohms.
Amplification Constant.....	.25
Watts Output.....	250 normal
Dimensions (over all).....	5 in. x 14½ in.
Base	Special Mounting

Type C-304 250-Watt Power Tube

Type C-304, 250-watt power tube, is the largest power tube sold for amateur and experimental use. It is similar in design to the large power

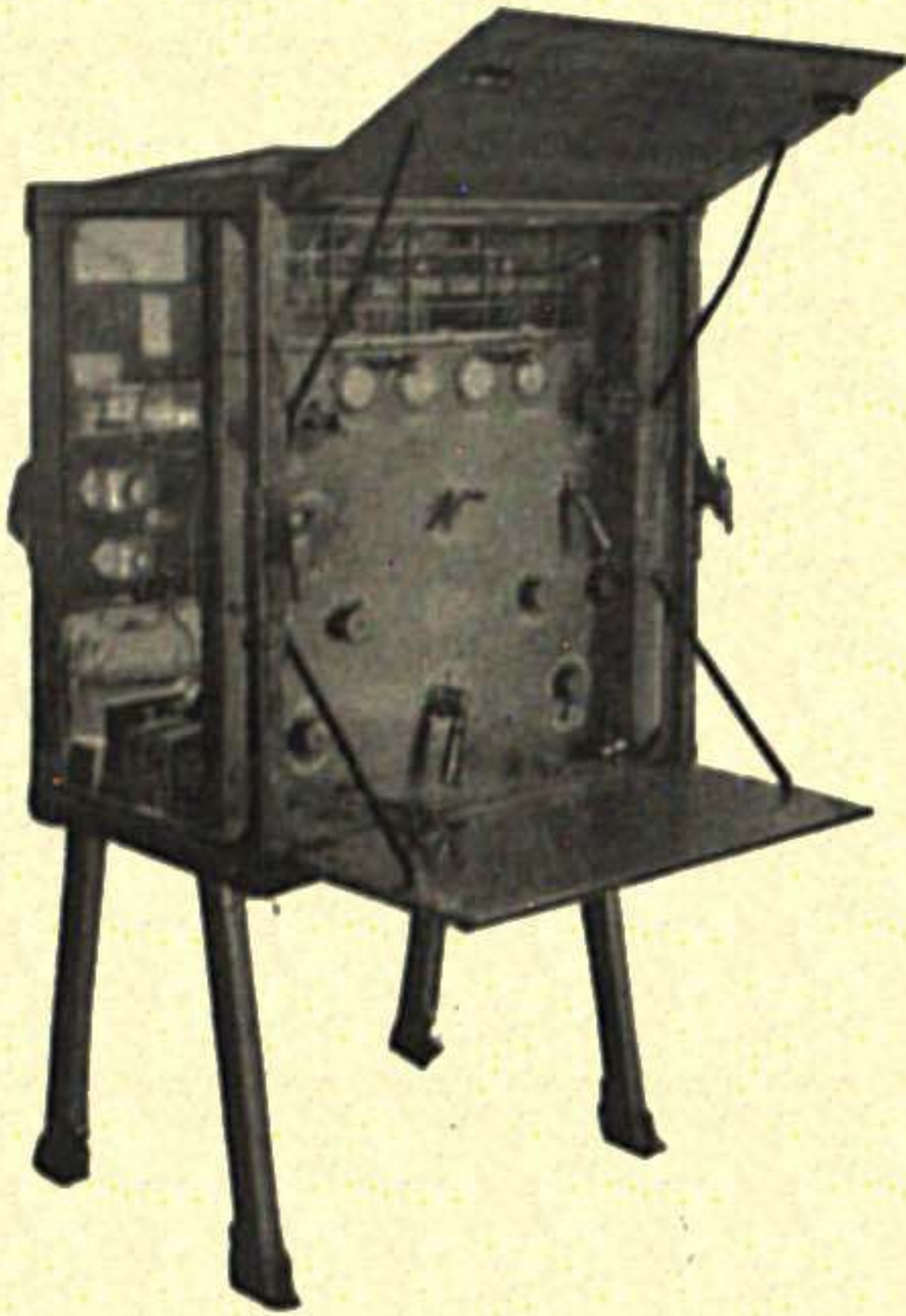

Fig. 246
Army Transmitter



Fig. 247
Army Transmitter

tubes furnished by the General Electric Company to the United States Navy.

Because of the extremely high plate voltage used, the plate terminal has been brought out at the opposite end of the tube from the other three terminals. This arrangement allows the use of a special mounting that supports the tube from both ends, and facilitates the special wiring required to successfully handle the necessary high voltage.

The operating characteristics of this tube are practically the same as those of the 50-watt power tube, type C-303, and it may be used as an oscillator, modulator or power amplifier when employing transmitting circuits that utilize 250-watt tubes as power amplifiers.

CUNNINGHAM TRANSMITTING TUBES

Type C-302, Five-Watt Power Tube

Type C-302 is a 5-watt power tube, mounted on a four-prong standard base, designed for use in a low-power transmitter, either as an oscillator or modulator. It is ideal for a transmitting set of low initial and

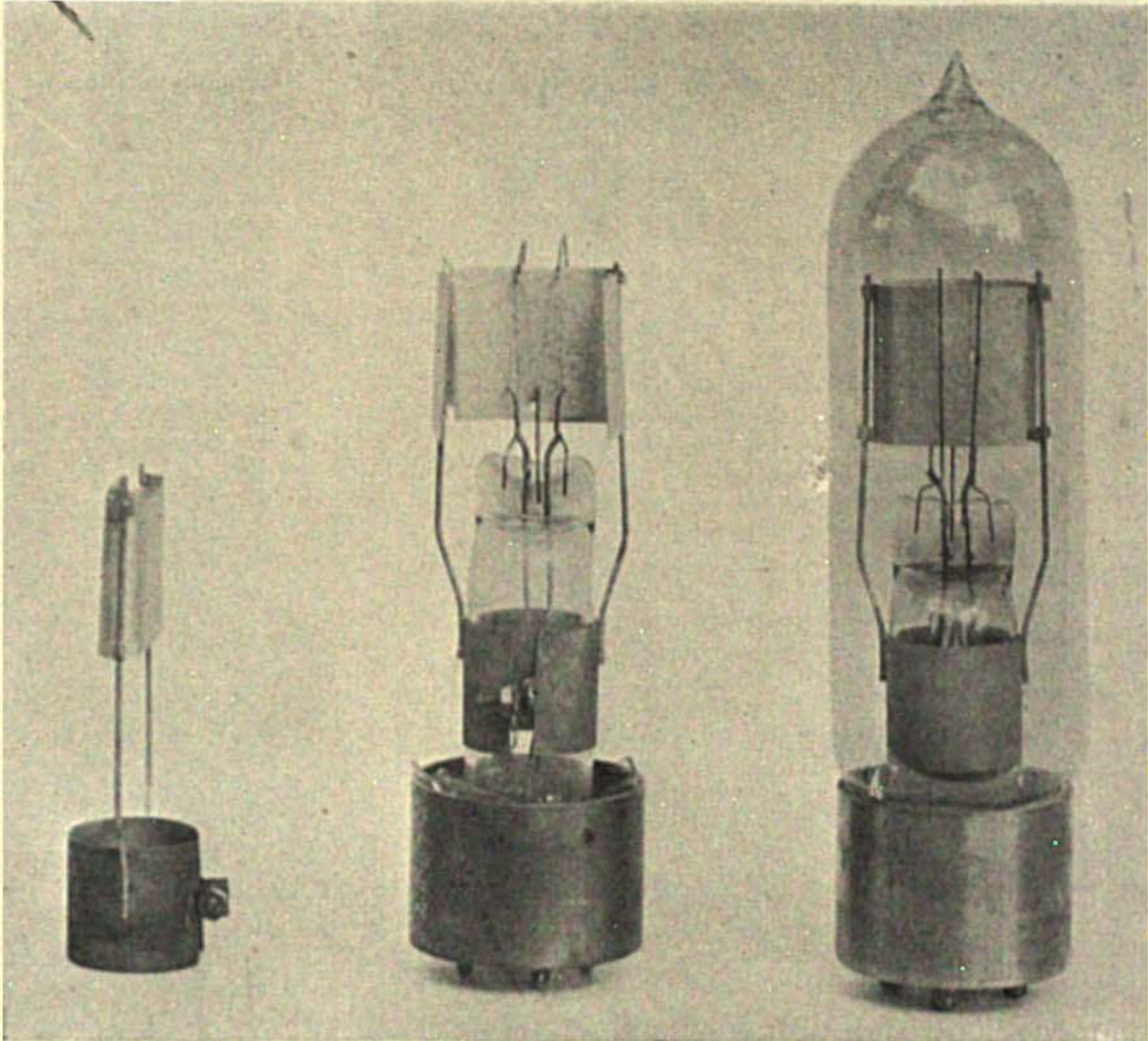

Fig. 248
150-Watt Kenetron

low operating cost. Two or three of these tubes can be operated in parallel to obtain outputs of 10 to 15 watts. When used in telephone transmitting sets the number of modulator tubes should always be equal to the number of oscillator tubes. In order to obtain the best possible modulation it is recommended that an input speech amplifier be employed using the type C-301-A amplifier tube.

C-302 makes an ideal speech amplifier tube for telephone transmitting sets employing the 50-watt power tube, type C-303, as oscillator and modulator.

The table of specifications gives a general description of this tube, and care should be taken never to exceed the rated values of plate and filament potential.



Fig. 249
50-Watt Radiotron



Fig. 250
W. E. 50-Watt Tube

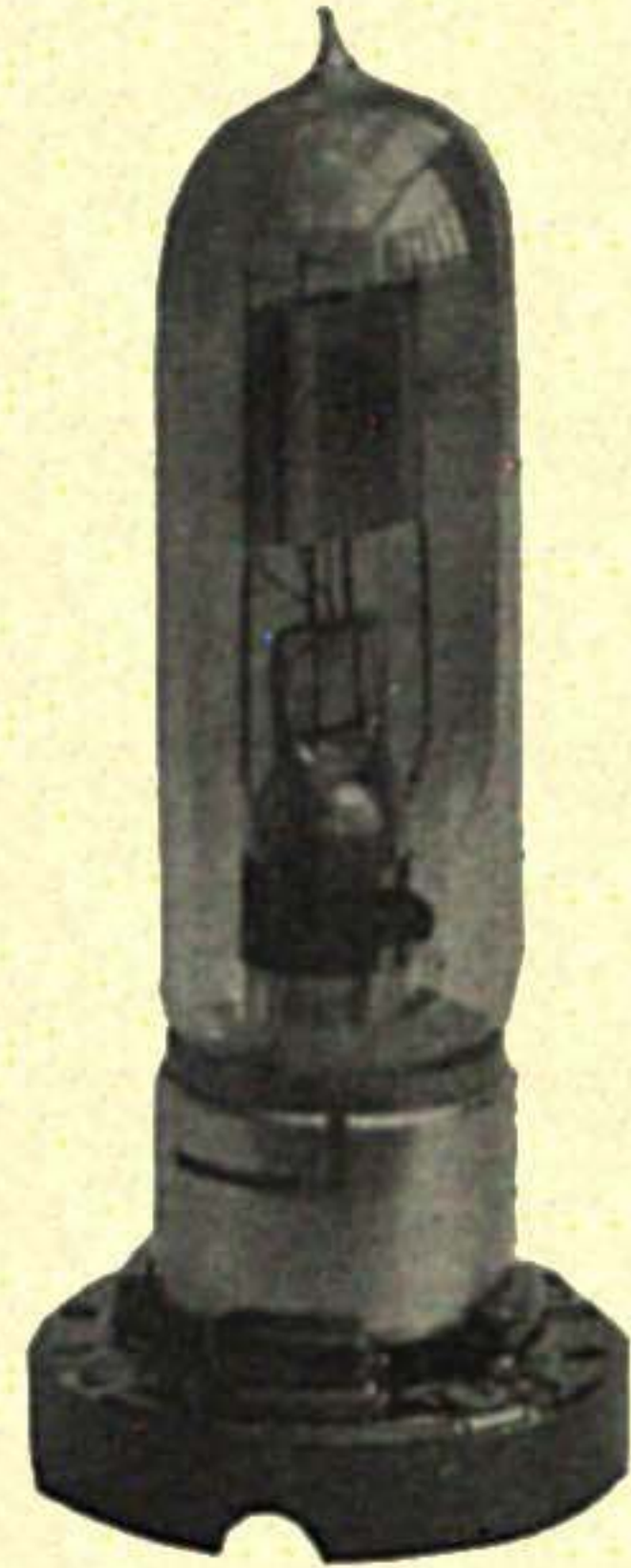

Fig. 251
W. E. 250-Watt Tube

SPECIFICATIONS

C-303

Filament Terminal Voltage.....	7.5 V.
Filament Supply Voltage.....	8 V.
Filament Current.....	2.35 Amp.
Plate Voltage.....	350 V. normal
Plate Current.....	.045 normal
Output Impedance.....	4,000 ohms.
Amplification Constant.....	7.5
Watts Output.....	5 normal
Dimension (over all).....	2½ in. x 5¼ in.
Base	4 Prong Standard

Type C-303, Fifty-Watt Power Tube

For obtaining greater power output, and consequently greater range in either a CW or a telephone transmitting set, Type C-303, 50-watt power tube should be used. This tube is similar in operating characteristics to our C-302, but is somewhat different in mechanical design, considerably larger, and is mounted on a special four-prong base having plate and grid terminals diagonally opposite. This arrangement of the

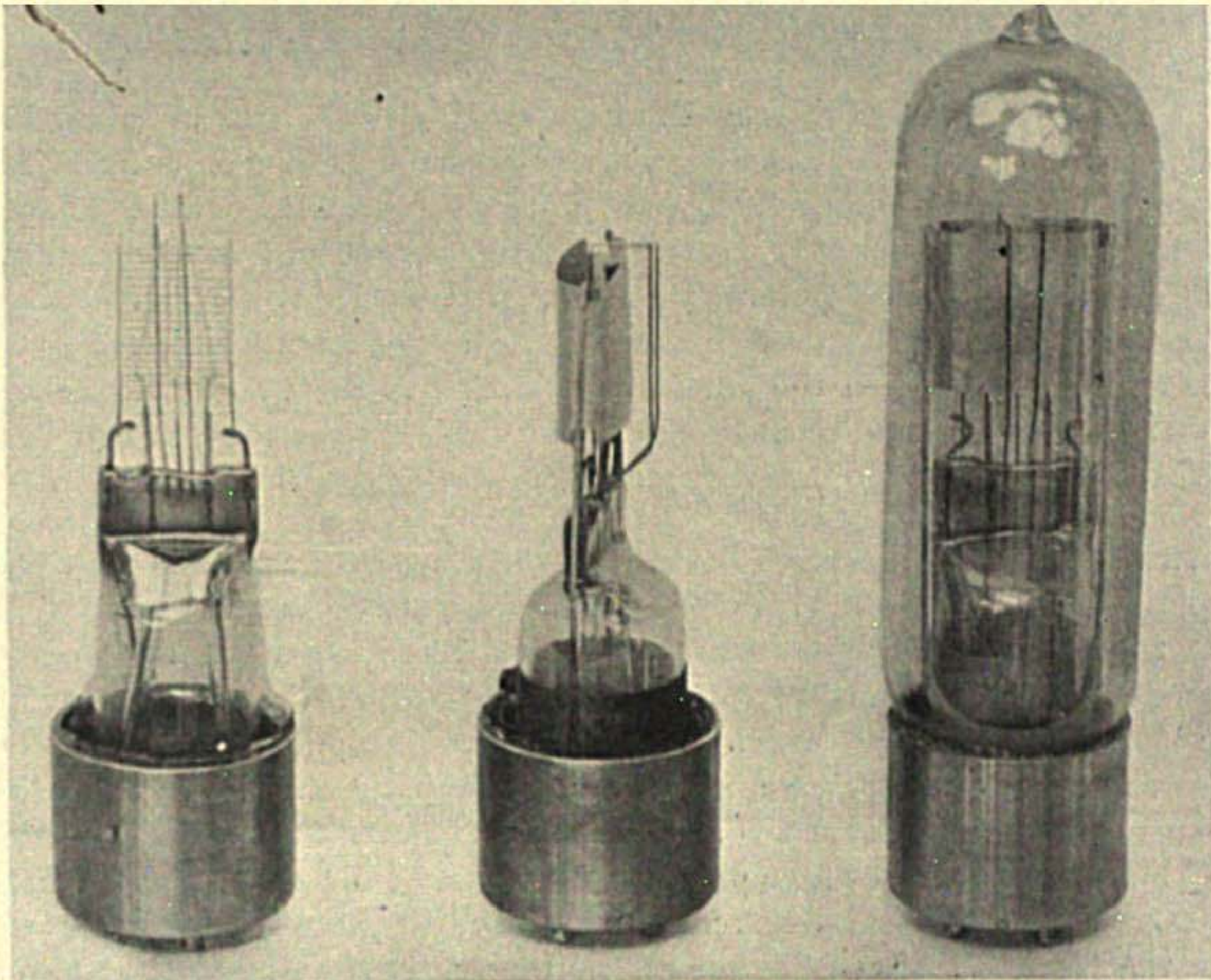

Fig. 252
50-Watt Radiotron

terminals is employed to prevent arcing, due to the high plate voltage used.

Similar to the C-302 this tube may be used either as an oscillator or modulator. It is also suitable for use as a power amplifier in transmitting sets employing the 250-watt power tube, type C-304.

Several tubes may be used in parallel to increase the power output.

SPECIFICATIONS

Filament Terminal Voltage.....	10 V.
Filament Supply Voltage.....	12 V.
Filament Current.....	6.5 Amp.
Plate Voltage.....	1,000 V. normal
Plate Current.....	.15 Amp.
Amplification Constant.....	10
Watts Output.....	50 normal
Dimensions (over all).....	2 in. x 7½ in.
Base	4-Prong Special

AMATEUR SHORT WAVE TRANSMISSION

The 80% Plate Efficiency Transmitter (Fig. 253) can be admirably adapted for short wave transmission 50 to 100 meters. Using an ordinary 50-watt tube at normal rating, 1,000 volts, 150 milliamperes, the total plate input is 150 watts. In ordinary circuits the antenna output is never more than 50% of the plate input which in this case would be 75 watts. We then have 75 watts lost in the plate tube and 75 watts delivered to the antenna circuit. If the efficiency is raised to 80%, 80% will be delivered to the antenna circuit and only 20% lost in the tube, in this case 120 watts to the antenna circuit and 30 watts lost in the tube.

In this last case it will be noted that the plate of the tube is only dissipating 30 watts while it is designed to dissipate 75 watts, accordingly, the tube runs cold and far below its actual rated capacity. The energy handled is 30 watts and 75 watts can be handled, so the total input can be increased $2\frac{1}{2}$ times, which would give a total input of 375 watts. Of this 375 watts, 75 watts are dissipated by the plate and 300 watts delivered to the antenna circuit compared with 75 watts originally. In order to obtain the high input, the plate voltage must be increased from 2,700 to 3,000 volts. Alternating current can be used in place of direct current for the plates if desired but the alternating current will have to be of a still greater voltage, namely, 1.4 to 2 times the voltage required with direct current.

An amateur station limited to 1,000 watts could obtain 800 watts in the antenna compared with 500 watts by the ordinary circuits, using three 50-watt tubes in parallel, or one 250-watt tube.

The whole secret of the system is very simple. A master oscillator tube is used to drive the power amplifier tube. The power amplifier tube is provided with a high negative potential, in the case of 50-watt tubes, 300 volts negative to grid. With the alternating grid voltage the plate component no longer takes the form of a sine wave, but powerful impulses of short duration and the efficiency increases rapidly.

The feature of master oscillator for short wave work is highly desirable as changes in the antenna circuit do not affect the frequency.

For short wave work the Master Oscillator Inductance L4 and Antenna Inductance L1 should be made proportionally smaller according to the wavelength desired.

The following data relates to the circuit:

COMBINATION No. 1

Antenna Watts 50 to 100

	V-1	V-2
<i>Sym- bol</i>	Master Osc. 1-1 Watt	Amplifier 2-5 Watt
M-1	Jewell Model No. 64, 0-5 Amps.	
M-2	Jewell Model No. 54, 0-200 Ma.	
M-3	Jewell Model No. 54, 0-10 Volts	
M-4	Jewell Model No. 54, 0-1,500 Volts	
L-1	Osc. Trans., UL 1008	
L-2	Rad. Freq. Choke, UL 1655	
L-3	Rad. Freq. Choke, UL 1655	
L-4	Master Osc. Inductance	
C-1	Condenser, UC 1831	
C-2	Condenser, UC 1014	
C-3	Condenser, UC 1014	
C-4	Condenser, UC 1014	
C-5	Condenser, UC 1831	
C-6	Condenser, UC 489	
C-7	Condenser, UC 488	
R-1	Rheostat, PR 535	
R-2	Rheostat, PR 535	
R-3	20,000 Ohms-4 Milliamps	
R-4	Included with Voltmeter	
R-5	Resistor, 10,000 Ohms	
R-6	Grid Leak, UP 1719	
FT.	10 Volts-10 Amps.-Sec.	

COMBINATION No. 2

Antenna Watts 100 to 200

	V-1	V-2
<i>Sym- bol</i>	Master Osc. 1-5 Watt	Amplifier 4-5 Watt
M-1	Jewell Model No. 64, 0-7½ Amps	
M-2	Jewell Model No. 54, 0-500 Ma.	
M-3	Jewell Model No. 54, 0-10 Volts	
M-4	Jewell Model No. 54, 0-1,500 Volts	
L-1	Osc. Trans., UL 1008	
L-2	Rad. Freq. Choke, UL 1655	
L-3	Rad. Freq. Choke, UL 1655	
L-4	Master Osc. Inductance	
C-1	Condenser, UC 1831	
C-2	Condenser, UC 1014	
C-3	Condenser, UC 1014	
C-4	Condenser, UC 1014	
C-5	Condenser, UC 1831	
C-6	Condenser, UC 489	
C-7	Condenser, UC 488	
R-1	Rheostat, PR 535	
R-2	Rheostat, PR 535	
R-3	18,000 Ohms-5 Milliamps	
R-4	Included with Voltmeter	
R-5	Resistor, 10,000 Ohms	
R-6	Grid Leak, UP 1719	
FT.	10 Volts-15 Amps.-Sec.	

COMBINATION No. 3

Antenna Watts 300 to 400

	V-1	V-2
<i>Sym- bol</i>	Master Osc. 1-5 Watt	Amplifier 1-50 Watt
M-1	Jewell Model No. 64, 0-10 Amps.	
M-2	Jewell Model No. 54, 0-750 Ma.	
M-3	Jewell Model No. 54, 0-10 Volts	
M-4	Jewell Model No. 54, 0-3,000 Volts	
L-1	Osc. Trans., UL 1008	
L-2	Rad. Freq. Choke, UL 1655	
L-3	Rad. Freq. Choke, UL 1655	
L-4	Master Osc. Inductance	
C-1	Cond., .0003 Mf.-10 Amps.	
C-2	Condenser, UC 1806	
C-3	Condenser, UC 1806	
C-4	Condenser, UC 1806	
C-5	Condenser, UC 1831	
C-6	Two UC 489 in Series	
C-7	Condenser, UC 490	
R-1	Rheostat, PR 535	
R-2	Rheostat, PR 535	
R-3	18,000 Ohms-75 Milliamps	
R-4	Included with Voltmeter	
R-5	Resistor, 5,000 Ohms	
R-6	Grid Leak, UP 1718	
FT.	12 Volts-10 Amps.-Sec.	

COMBINATION No. 4

Antenna Watts 600 to 800

	V-1	V-2
<i>Sym- bol</i>	Master Osc. 2-5 Watt	Amplifier 2-50 Watt
M-1	Jewell Model No. 64, 0-15 Amps.	
M-2	Jewell Model No. 54, 0-1 Amp.	
M-3	Jewell Model No. 54, 0-10 Volts	
M-4	Jewell Model No. 54, 0-3,000 Volts	
L-1	Osc. Trans., UL 1008	
L-2	Rad. Freq. Choke, UL 1655	
L-3	Rad. Freq. Choke, UL 1655	
L-4	Master Osc. Inductance	
C-1	Cond., .0003 Mf.-10 Amps.	
C-2	Condenser, UC 1806	
C-3	Condenser, UC 1806	
C-4	Condenser, UC 1806	
C-5	Condenser, UC 1831	
C-6	Two UC 489 in Series	
C-7	Condenser, UC 490	
R-1	Rheostat, PR 535	
R-2	Rheostat, PR 535	
R-3	18,000 Ohms-150 Milliamps	
R-4	Included with Voltmeter	
R-5	Resistor, 5,000 Ohms	
R-6	Grid Leak, UP 1718	
FT.	12 Volts-15 Amps.-Sec.	

COMBINATION No. 5

Antenna Watts 900 to 1,200

Sym- bol	V-1	V-2
	Master Osc. 2-5 Watt	Amplifier 3-50 Watt
M-1	Jewell Model No. 64, 0-20 Amps.	
M-2	Jewell Model No. 54, 1-1½ Amps.	
M-3	Jewell Model No. 54, 0-10 Volts	
M-4	Jewell Model No. 54, 0-3,000 Volts	
L-1	Osc. Trans., UL 1008	
L-2	Rad. Freq. Choke, UL 1655	
L-3	Rad. Freq. Choke, UL 1655	
L-4	Master Osc. Inductance	
C-1	Cond., .0003 Mf.-10 Amps.	
C-2	Condenser, UC 1806	
C-3	Condenser, UC 1806	
C-4	Condenser, UC 1806	
C-5	Condenser, UC 1831	
C-6	Two UC 489 in Series	
C-7	Condenser, UC 490	
R-1	Rheostat, PR 535	
R-2	Rheostat, PR 535	
R-3	8,000 Ohms-150 Milliamps	
R-4	Included with Voltmeter	
R-5	Resistor, 5,000 Ohms	
R-6	Grid Leak, UP 1718	
FT.	12 Volts-25 Amps.-Sec.	

COMBINATION No. 6

Antenna Watts 1,000 to 1,250

Sym- bol	V-1	V-2
	Master Osc. 1-50 Watt	Amplifier 1-250 Watt
M-1	Jewell Model No. 64, 0-25 Amps.	
M-2	Jewell Model No. 54, 1-1½ Amps.	
M-3	Jewell Model No. 54, 0-15 Volts	
M-4	Jewell Model No. 54, 0-5,000 Volts	
L-1	Osc. Trans., UL 1008	
L-2	Rad. Freq. Choke, UL 1655	
L-3	Rad. Freq. Choke, UL 1655	
L-4	Master Osc. Inductance	
C-1	Cond., .0003 Mf.-20 Amps	
C-2	Condenser, UC 1806	
C-3	Condenser, UC 1806	
C-4	Condenser, UC 1806	
C-5	Special, See Spec.	
C-6	Four UC 490 in Series	
C-7	Two UC 490 in Series	
R-1	Rheostat, PT 537	
R-2	Rheostat, PR 535	
R-3	32,000 Ohms-200 Milliamps	
R-4	Included with Voltmeter	
R-5	Resistor, 6,000 Ohms	
R-6	Grid Leak, UP 1718	
FT.	14 Volts-25 Amps.-Sec.	

MOTOR GENERATOR DATA

Comb.	Motor	Generator		Filiment Generator		
1	¼ H.P.	1,000 Volts	200 Watts	10 Volts	10 Amps.	100 Watts
2	¾ H.P.	1,000 Volts	250 Watts	10 Volts	15 Amps.	150 Watts
3	1 H.P.	2,500 Volts	500 Watts	12 Volts	10 Amps.	120 Watts
4	2 H.P.	2,500 Volts	1,000 Watts	12 Volts	15 Amps.	180 Watts
5	3½ H.P.	2,500 Volts	1,500 Watts	12 Volts	25 Amps.	300 Watts
6	4 H.P.	5,000 Volts	1,500 Watts	14 Volts	25 Amps.	350 Watts

Note—Field regulators for generators G1 and G2 are specified by generator manufacturer.

MASTER OSCILLATOR INDUCTANCE DATA FOR COILS

For 5-Watt Tube Oscillator—Black Formica Tube, 3½ in. Dia. x 4 in. Wide, ⅛ in. Wall.
Wind 60 Turns No. 20 D. C. C. Wire. Tap Every Two Turns.

For 50-Watt Oscillator—Black Formica Tube 3½ in. Dia. x 5 in. Wide, ⅛ in. Wall.
Wind 60 Turns No. 16 D. C. C. Wire. Tap Every Two Turns.

Condenser "C-5" for Combination No. 6 Should Be .0003 Mf. Maximum, to Stand 6,000 Volts.

BI-GRID BIAS DATA

Size Tube	Grid Voltage
V2-1 or More	Use No. 767 Eveready—45-Volt Unit
5-Watt	Start at 10 Volts Increase to 150 Volts
50-Watt	Start at 30 Volts Increase to 300 Volts
250-Watt	Start at 30 Volts Increase to 450 Volts

OPERATING INSTRUCTIONS.

Set Inductance L4 and C5 to the desired wavelength, usually 200 meters, measuring wavelength by means of the wavemeter. It is only necessary to have "V1" filament barely heated during this operation, disconnecting plate potential from "V2."

Connect plate potential to "V2," heat filament of "V2" and start with normal plate potential, which is as follows—350 volts for 5 watt, 1,000 volts for 50 watt and 2,000 for 250 watt.

Start with 30 volts negative, bias—for "B1."

Bring antenna circuit into resonance by tuning on "L1" and "C1," for maximum output. Increase plate voltage and increase bias, keeping plate dissipation not much more than normal.

EFFICIENCY IS DETERMINED AS FOLLOWS

Input—Input in watts = plate voltage \times plate amperage.

Example—Plate volts = 2,500, plate amps. = .4.

Then input = 2,500 \times .4 = 1,000 watts.

Output—Output in watts = antenna current in amps., squared, times the antenna resistance in ohms.

Example—Ant. current = 8.9 amps. Ant. resistance 10 ohms.

Then $(8.9)^2 \times 10 = 79.21 \times 10 = 792.1$ watts.

Efficiency—The efficiency = the output divided by the input.

Example—792.1 watts \div 1,000 watts = .7921 watts or approx. 80%.

Power—Power available from one tube at 80% efficiency, is four times normal plate dissipation. Normal plate dissipation is as follows: 5 watt tube = 7.5 watts, 50 watt tube = 75 watts, 250 watt tube = 250 watts.

Lead running from B1* to L4 should be adjusted to give high efficiency with greatest stability.

In the 100 meter transmitting circuit shown (Fig. 254), the grid coil consists of 14 turns $\frac{1}{2}$ " copper strip 10" diameter, turns spaced $\frac{5}{16}$ inch. The plate coil should be two turns of 2" strip copper 11" diameter the two turns spaced $1\frac{1}{4}$ ". The Loop Coupling Coil consists of 3 turns 1" copper strip 12" diameter, turns spaced $1\frac{1}{4}$ ". The plate coil is located about two inches from the antenna coil, and the grid coil is arranged for variable coupling in relation to the plate coil. In the event that an antenna is

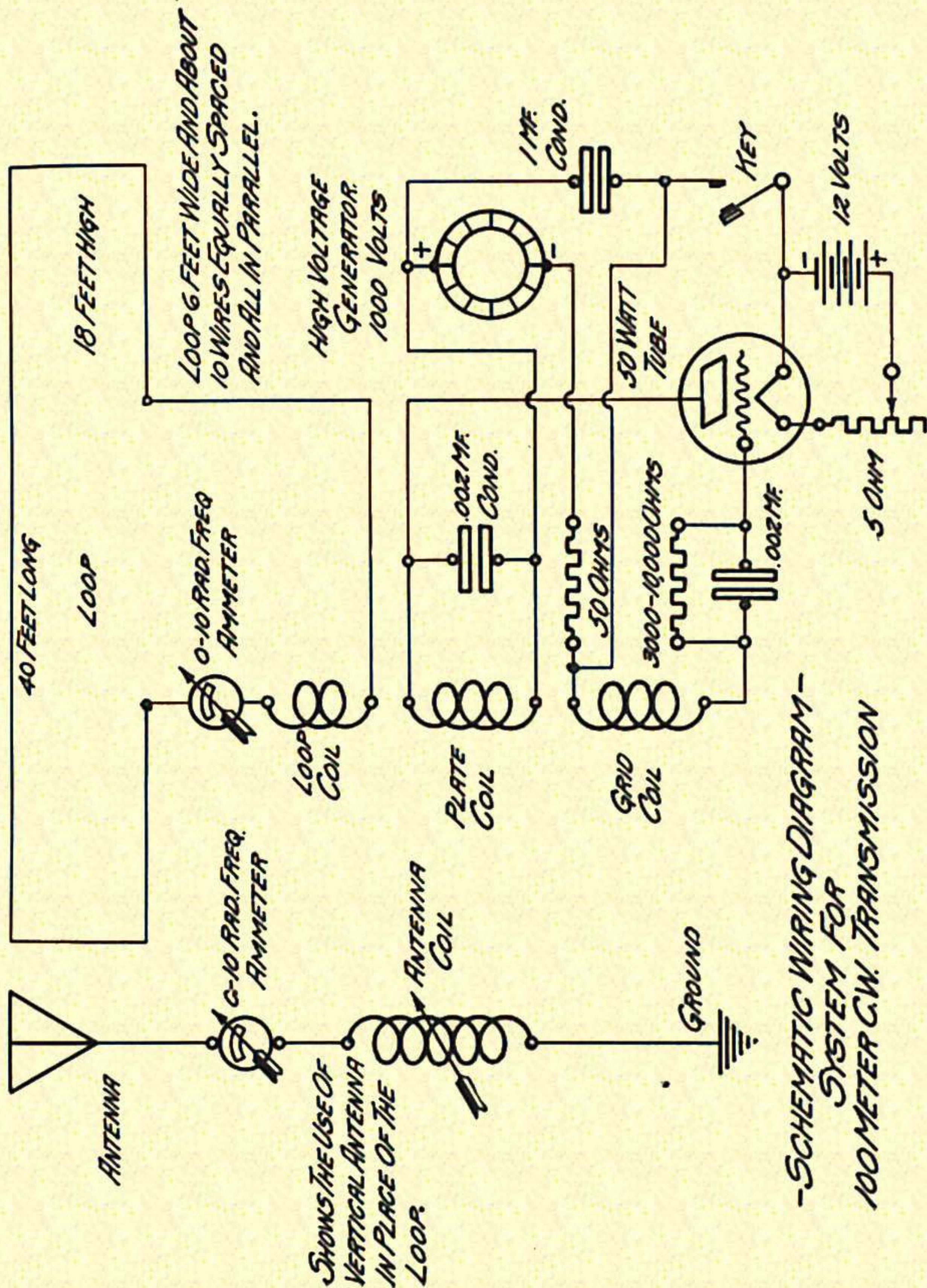

Fig. 254

used in place of the loop shown, experiments would have to be made to determine the exact period of the antenna for absolute resonance. This could best be determined by trial. This same circuit can be adapted to still shorter wavelengths by reducing the three coils in proportion. While one 50 watt tube is shown in the circuit, a number of these tubes could be connected in parallel or a smaller or larger transmitting tube used here.

The Bureau of Standards developed this circuit and in actual tests has been able to establish a consistent daylight range of 200 miles.

CHAPTER VII

GENERAL DATA

In a suit of the Westinghouse Electric & Manufacturing Co. and Radio Corporation of America vs. Experimenters' Information Service, Inc., the following affidavit of Elmer E. Bucher, sales manager of the Radio Corporation of America was offered:

UNITED STATES DISTRICT COURT

Southern District of New York

Westinghouse Electric & Manufacturing Company and Radio Corporation of America, Plaintiffs, vs. Experimenters Information Service, Inc., Defendants.	}	In Equity No. 29/110
--	---	-------------------------

AFFIDAVIT OF ELMER E. BUCHER

State of New York }
County of New York } ss.:

ELMER E. BUCHER, being duly sworn, deposes and says, as follows:

I am manager of the Sales Department of the Radio Corporation of America, which is licensed under the three patents in suit, Fessenden No. 1,050,441, No. 1,050,728, Armstrong No. 1,113,149, and which is now selling, under such license, radio receiving sets of the super heterodyne type, containing the inventions of these patents. Our sales are directly and seriously affected by unlicensed infringers selling and offering for sale such receivers.

The development of efficient and satisfactory radio receiving apparatus is an extremely difficult and expensive undertaking. The radio art is not standardized but is rapidly advancing and the advances of one day are very apt to become obsolete within a very comparatively short time. The public demands, and is entitled to have, the very best that inventive and engineering skill can contribute. Moreover, it should be noted that the great increase in the number of broadcasting stations

with the result of filling the air with many times the number of ether or radio waves has increased the necessity for a very select receiver. Formerly, there was a comparatively wide spread between transmitting stations operating at a given time but this is not true now. Also, the demands for distance reception have greatly increased, so that the average listener today is not content unless he can receive stations many thousands of miles away, and even those across the ocean.

In order to place before the public the best possible types of receiving apparatus, the Radio Corporation, Westinghouse and General Electric Companies have maintained thoroughly equipped research and experimental laboratories, where scientists and engineers are engaged in working on the many problems attendant upon the improvement of receiving apparatus. Many very valuable inventions have been made by those in the employ of these companies.

Furthermore, as in the case of Fessenden and Armstrong patents in suit, inventors entirely outside of the organization of these companies have been encouraged to devote their time and energies to the improvement of the radio art through the making of useful inventions. Many hundreds of thousands of dollars have been paid to such inventors for their patent rights. For example, Edwin H. Armstrong was a young student at Columbia University when he made the invention of his patent here in suit and which he later sold to the Westinghouse Company.

The super heterodyne set employs the best and regenerative principles of reception, utilizing usually six to eight tubes. Although the capabilities of this instrument had been recognized for some time, yet in its original form it was an extremely complicated device which introduced many serious and complex difficulties in its practical construction, which would not permit of quantity production. In addition, it possessed an undesirable feature in that it re-radiated energy, causing marked interference to the operation of neighboring radio broadcast receivers. Further, it required an excessive number of tubes to give the requisite sensitivity and volume of reproduction.

It was therefore necessary for our research forces to find a solution to three fundamental problems:

First—A reduction in the number of tubes without decreasing the sensitivity and volume of reproduction.

Second—The development of circuits and mechanical features which would permit the device to be put into quantity production.

Third—The elimination of radiation, i.e., interference to a neighboring receiving set.

We have felt that we should not offer super-heterodyne sets to the public until these engineering and production difficulties had been smoothed out, as not only would the high reputation generally of our products suffer but the great advantages of super heterodyne sets might not be fully appreciated. It has only been within the last few months that we have been able to advertise and put on the market Radiola of improved super heterodyne type.

There is a great demand today for selective and long distance reception. There are many types of sets, other than the super heterodyne, which are fairly good sets. That is, the listener can hear signals with varying degrees of intensity and clarity, but with some interference from undesired sources of radio waves. But the super heterodyne is regarded today as a supreme achievement in radio science. It is often termed "the Rolls Royce of Radio." We sell it as our highest-priced set, as appears from our current advertisements, a copy of one being attached hereto as Exhibit A.

If unprincipled infringers should be allowed to appropriate and use patented inventions without cost, it is obvious that expensive and highly specialized research and development organizations cannot be maintained. Also, that it would be futile to pay hundreds of thousands of dollars to outside inventors for their patent rights, if those rights were valueless. Although tremendous strides have been made, and a great deal accomplished in the perfecting of radio apparatus, there remains such to be done, which cannot be achieved without constant experimenting, testing and encouragement to inventors.

It is probably unnecessary for me to point out that many infringers are not only entirely irresponsible financially but are also incompetent to manufacture an efficient receiving set of the complicated nature of the super heterodyne. They have not the necessary engineering experience or ability. The result is that the purchaser of a super heterodyne from them finds that it is no better than sets of other types and may therefore think there is no real superiority in any super heterodyne, which is not true. The recognition of the merits of the super heterodyne is well pointed out in the affidavits of Messrs. Cockaday and Lynch in a suit in this court by the same plaintiffs against Morris Taub, copies of which affidavits I am attaching hereto for the convenience of the court as Exhibits B and C.

There is no adequate relief against such infringers as the present defendants other than an injunction. The damage to us and our dis-

tributors by such open and defiant infringement can never be accurately measured, in dollars and cents, even if a money judgment should eventually be collected which is certainly doubtful.

ELMER E. BUCHER.

Subscribed and sworn to before me this 13th day of June, 1924.

Francis S. Kane,

Notary Public.

[L. S.]

Notary Public Queens Co. No. 578

Certificate Filed New York County

New York County Clerk's No. 380

New York Register's No. 6319

Commission Expires March 30, 1926.

It will be noted from the above affidavit that it is Mr. Bucher's sworn belief that "The public demands, and is entitled to have, the very best that inventive genius and engineering skill can contribute."

The writer believes that his design of super heterodyne known as the Model C-7 is superior to the Radiola super heterodyne in regard to quality of reproduction, volume, sensitiveness, quality of materials, quality of workmanship and general appearance value and at least equal in regard to selectivity. If this is true, this Model C-7 super heterodyne should be available to the public who according to Mr. Bucher, is entitled to the best.

The writer is open to prove the above assertion and is ready to operate his Model C-7 super heterodyne in a comparative test against a Radiola super heterodyne operated by Mr. Bucher under identical conditions and before three competent disinterested judges, one to be selected by Mr. Bucher, one by the writer and a third judge mutually satisfactory to Mr. Bucher and the writer.

It is understood that if the writer is unable to prove his assertion he will pay \$5,000 cash to any charitable institution the judges may name. If the writer is able to prove his case, he is ready to guarantee the Radio Corporation of America \$100,000 yearly minimum royalty for a complete license to manufacture and market the Model C-7 super heterodyne for a period of five years. The royalty not to exceed 10% of the list price of the set.

In the above affidavit Mr. Bucher states "The radio art is not standardized but is rapidly advancing and the advances of one day are very apt to become obsolete within a very short time." This is very true but Mr. Bucher apparently does not believe that the public should know this,

for quite to the contrary in a circular issued by the Radio Corporation of America's Sales Department, entitled "There's no Place Like Home"—with a Radiola, there is made the following statements: "The overwhelming demand for radio receivers, far in excess of manufacturers' anticipations, makes it advisable for the purchaser to exercise the utmost caution in order that his choice may assure him of complete and lasting efficiency. Thus only will his outlay prove a profitable investment. Those who secure the new RADIOLA RECEIVER (AR-1300) and DETECTOR-AMPLIFIER (AA-1400) are permanently equipped with apparatus embodying high standards—in design and quality of workmanship." Further on it continues "The design of the AR-1300 and AA-1400 units is identical with other units providing additional amplification, so that the capabilities of the equipment may increase step by step in a manner similar to the building up of a section bookcase without rendering the initial investment obsolete or detracting from the appearance of the installation."

These two units are no longer offered by the Radio Corporation of America and the people that did buy this receiver most certainly did not receive "complete and lasting efficiency," "prove a profitable investment" nor are they "permanently equipped with apparatus embodying high standards." The fact that this model among others was withdrawn in favor of later models proves that the early models were not proving satisfactory.

Gimbel Brothers, a large department store in New York City, with other stores in Philadelphia and Milwaukee, whose total annual business is several times larger than that of the Radio Corporation of America, published some full page ads in the New York daily papers August 25, 1924. An extract from one of them is as follows:

YOU MAY WANT TO KNOW

Question—How many Radiola R. C. Sets were involved in the Gimbel sale of a year ago?

Answer—Beginning in July, 1923, Gimbels distributed over 25,000 R. C. Sets in a period of twenty-one days.

Question—How much did the R. C. Set sell for?

Answer—The R. C. Set sold for \$79.75 complete with loud speaker. (With head phones and without loud speaker the price was \$59.75.)
CURRENT MARKET VALUE WAS \$172.50.

Question—Are the R. C. Sets giving satisfaction?

Answer—They are, except that several new and powerful broadcasting stations in the heart of the city make it almost impossible to hear one station without interference from others, except by the addition of cumbersome extra equipment—wave traps and the like. The R. C. Set gives very clear and very loud signals, but often from several stations at the same time.

As early as April, 1923, the Experimenters Information Service were exclusively advocating the Model C Super Heterodyne and pointing out the disadvantages of the Single Circuit and ordinary regenerative receivers. At the same time the Radio Corporation of America were marketing single circuit receivers, principally most models of which have since been withdrawn. For comparative example of results obtained a Mr. Levy, at Wellington, New Zealand, is operating an eight-tube Model C Super Heterodyne and has been obtaining consistent loud speaker reception from KGO Oakland, Cal., a distance of over 6,000 miles and uses only a loop.

The Blue Prints of the Model C Super Heterodyne were the first complete constructional details of the Super Heterodyne offered to the public. A few suspicious experimenters built Model C's from the Blue Prints and the results obtained were so far in advance of those obtained with the old single circuit and regenerative receivers, that the tremendous success of the Model C was as rapid as wild fire. The many grateful testimonial letters from Model C customers in the files of the Experimenters Information Service prove conclusively that they won the hearts of the advanced experimenter.

In one of the first Radio Corporation of America catalogs they listed a radio frequency transformer known as the UV1716. This transformer was advertised for sale as a long wave radio frequency amplifying transformer and as the number of experimenters that tinker with long wave reception is very limited the demand for this transformer was comparatively small. Dealers that had some in stock did not know when they would dispose of them. About April, 1923, the Model C Blue Prints came out and these specified three of these UV1716 Transformers as part of the design.

In a few months all the available UV1716 transformers had been bought up. The Experimenters Information Service at that time handled radio parts as dealers and they ordered large quantities of these transformers through their jobber. At a time when they had standing orders for several thousand of these transformers the Radio Corporation of America apparently decided that they would not sell any more to the Experimenters Information Service, as they would not deliver to their jobber. However, it

is a known fact that although Experimenters Information Service orders were in first place their jobber was not supplied, although other jobbers were supplied. Similar transformers made by other manufacturers soon relieved the situation. It was nearly a year from this date before the R. C. A. brought out their Radiola Super-Heterodyne.

In the current Radio Corporation Catalog entitled "Radiolas," section 3 of the Patent Notice reads as follows:

"(3) To meet and develop the interest of amateurs in the radio art, such amateurs are, until further notice, authorized under the patents under which the Radio Corporation of America has the right to grant licenses, to assemble and use sets (but only for amateur and experimental radio purposes as stated above defined in section (1), providing the tubes forming elements of, or used with, such sets have been sold by the Radio Corporation of America or such other persons, if any, as have been authorized by it to manufacture and sell the same for use in the United States of America, and providing that such amateur does not use any assembled or partially assembled set, but himself assembles the various distinct parts."

Section (1) reads as follows:

"(1) Purchasers of tubes, grid leaks, transformers, condensers, or other parts, or of sets are not licensed by the Radio Corporation of America under any patents owned by the Radio Corporation of America, or under which it is licensed to use the same for commercial purposes. The sole license the purchaser of any set obtains by the purchase thereof is to use it for amateur and experimental radio use involving no feature and including broadcast reception of news and music and other entertainments but not broadcast transmission."

According to the above, an amateur or experimenter may buy parts and assemble them and combine circuits the patents of which are controlled by the Radio Corporation of America, and enjoy experimental and broadcast reception. The sole purpose of the Experimenters Information Service is to show the experimenter and amateur how to assemble these various parts to obtain the high possible results with the least worry and expense and having succeeded in accomplishing this for a large clientele their policy will remain unchanged. Reliable statistics show that over 50% of all radio sales are parts and it is therefore realized that a competent information service is a welcome guiding hand for the experimenter and amateur, and in this respect the Experimenters Information Service hold a unique and solitary position in the radio industry.

A few of the many unsolicited letters from strangers confirming this statement are reproduced for consideration.

Mr. Bucher's sworn affidavit referring to the early form of super-heterodynes, says, "In addition, it possessed an undesirable feature in that it re-radiated energy, causing marked interference to the neighboring radio broadcast receivers." Re-radiation from a receiver means that the receiver picks up radiation and re-radiates it, and without any exception this can happen in any receiver to some extent and cannot be eliminated or is there any reason to try and prevent it.

Further on in the same affidavit Mr. Bucher states it was necessary for the Radio Corporation of America research forces to find a solution to three fundamental problems, one of which was as follows:

"Third—The elimination of radiation, i.e., interference to a neighboring receiving set."

This fundamental problem has most certainly not been solved in the current Radiola Super-Heterodyne, as it does radiate energy and will interfere with neighboring receivers contrary to their statements otherwise. The oscillator tube in Radiola Super-Heterodyne is coupled inductively to the loop and this loop radiates energy of considerable magnitude at the fundamental wavelength and harmonics. The oscillator coupler or inductances of the Radiola Super-Heterodyne are not shielded and they radiate energy directly which would alone cause interference with neighboring sets due to the oscillator oscillating at harmonics also. Two Radiola Super-Heterodynes operated in the same building can cause considerable interference between themselves. The situation of a New York Apartment house containing several sets can well be imagined.

The Radiola Super-Heterodyne is operated on the "second harmonic" principle which gives the advantage of being able to use one tube for both the local oscillator and first detector, and also gives some disadvantages. In this second harmonic system, if it is desired to tune to a 300 meter station, the oscillator must be tuned to slightly above or below 600 meters and the second harmonic of the oscillator (slightly above or below 300 meters) heterodynes the signal through the amplifying system. The loop is tuned to 300 meters. Now while the system is tuned to 300 meters and the 300 meter station may be heard, the oscillator working at the fundamental wavelength of 600 meters will heterodyne through 600 meter stations which are the powerful ship and telegraph stations that cause considerable interference.

Suppose again that we have one of these Radiola Super-Heterodynes in St. Louis and we wish to receive a 273 meter New York station. The wavelength of the St. Louis station KSD is 546 meters. To tune to the 273 meter New York station, the oscillator system must be adjusted to slightly above or below 546 meters and it is then found that the local 546 meter station is heterodyne through and it is impossible to tune in the 273 meter station while the St. Louis station is on.

Likewise with a Radiola Super-Heterodyne located in New York City as soon as it is tuned to wavelengths approximately 226, 246 or 263 meters, it is found that WJZ, WEAJ and WNYC (455, 492 and 526 meters respectively) are found in an entirely separate calibration space on the dials than from their proper position, and that the shorter wavelengths above mentioned cannot be received without interference from the New York stations. This disadvantage is not found in the Model C and C-7 Super-Heterodynes when used over the broadcast wavelength range.

In the January, 1923, issue of "Radio News," page 1393, is an advertisement of the Model "L" 10-tube Super-Heterodyne and the Blue Print designs of this advanced receiver were available and recommended several months previous to date. "Radio News" is recognized as the leading radio advertising medium yet in that same issue there is not another single advertisement of any concern or individual advocating or recommending the Super-Heterodyne method of reception. This only points out that no one else realized the field for this type of receiver. The Radio Corporation during that month were selling a series of models which have long since been discontinued.

The July, 1923, issue of "Radio News" (14 months ago), carried the first advertisement of the now famous Model "C" Super-Heterodyne Blue Print designs. In that issue not another receiver was advertised that can compare with the Model "C" in performance, and with perhaps one exception all the sets advertised at that time are now off the market and obsolete while the Model "C" built in strict accordance with the Experimenters Blue Prints is still superior to any finished set on the market today including the Radiola Super-Heterodyne, and is only exceeded in performance by the Experimenters C-7 design. The best set offered by the Radio Corporation was the "Radiola Grand" and the writer suggests that the reader take Packard's advise and "ask the man who owns one." In March, 1924, issue "Radio News" Radio Corporation made first public announcement of the coming Radiola Super-Heterodyne, over 14 months after Experimenters started advocating this system, and 8 months of the introduction of the Model "C."

Although Experimenters advertised the Super-Heterodyne designs for 14 months previous to the introduction of the Radiola Super-Heterodyne, the Radio Corporation over that long period never questioned our implied patent license to conduct such a service. Immediately after they were prepared to market a competing instrument, Experimenters Information Service were suited. The fact seems that the Radio Corporation was contented to let Experimenters rub the rough spots off the field, let them introduce the Super-Heterodyne and that advertising would eventually accumulate in the Radio Corporation's favor.

Radiola Regeneflex is one of the new Radio Corporation Models and sells for \$150 and the writer has been unable to make it compare with the Pliodyne 6 for selectivity, volume, range, quality of reproduction, simplicity. The Pliodyne 6 only costs \$60 and is non-reflexed, and non-regenerating.

In the November, 1923, issue of "Q. S. T.," an article by C. D. Tuska on "The Superdyne Receiver," insinuates that on some stations better results were obtained on the four-tube Superdyne than on an 8-tube Super-Heterodyne. If Mr. Tuska believes this to be a fact and does not realize that such a comparison is ridiculous, the writer will be pleased to enter a Model C-7 seven-tube Super-Heterodyne against the finest four-tube Superdyne Mr. Tuska ever set hands on and will guarantee to exceed the Superdyne's performance in any respect. The writer would prefer to make the test in New York City close to interference.

Abstract from "New York American," September 25, 1924:

"RC" Set Not Selective

A. Russo—I have an "RC" set that is not selective. I live at West Houston and McDougal Streets, New York City. Please advise me in your valuable columns how I can make this set selective.

Answer—The "RC" set, which is no longer made, is notorious for its poor tuning qualities, etc.

The A. and P. Radio Co. of New York and Brooklyn is advertising an 8-tube Super-Heterodyne, and one of the outstanding advertising features is "Absolutely no static." This is of course absurd as a real static eliminator would bring several million dollars cash. This points out, however, the extent new firms will go, to secure business whether they satisfy their customer or not is no consideration at all.

The conditions in the radio field today are very similar to conditions in the automotive industry twelve of fifteen years ago. The writer re-

members in an incident where a manufacturer had just equipped his car with an electric self-starter and generator system. The salesman explained the emergency value of this equipment. In case of an accident to the gasoline motor, the electric self-starter motor would drive the car and one could travel any distance this way as the generator would keep the storage battery charged. In other words he had perpetual motion and did not need the gasoline motor.

One can turn to any radio periodical and find claims just as ridiculous. It is a general idea that fortunes are being made in the radio industry by everyone connected with the field. This is not true. All the cases that the writer is familiar with runs down to the cold fact that the failures of new radio concerns far exceeds successes.

However, while the new inexperienced firms are struggling for a short existence, they do sell some goods which in general give little satisfaction to the buyers and results in the poor buyer forming a poor opinion of radio in general.

Before a man buys an automobile he rides in several types and selects the one that suits his particular requirements, considering price limits. Radio sets should be bought under the same plan. The set should be tried at its future location to determine if the set will function satisfactorily at that location. An unselective receiver might give fairly good results in the center of Texas, but would be useless in the heart of New York City.

Golden-Leutz, Inc., have made a radical departure in sales methods with a view to giving the customer every consideration. They send their new Pliodyne 6's, C.O.D. with privilege of inspection. The customer orders one and inspects same before accepting same from the express company. Upon inspection, if it does not meet with his approval it can be ordered returned and all the express expense is paid by Golden-Leutz, Inc.

On the other hand if the receiver measures up to the customer's ideas, he accepts the C.O.D. and is allowed a five-day trial period. The customer tries the set for five days and has an opportunity to see just what results can be obtained. If the results are not satisfactory in every way, the receiver can be returned to the manufacturer and the money paid is refunded without question.

Golden-Leutz, Inc., have such sincere confidence in this receiver that they are able to carry on this marketing plan successfully and it is being proved that the percentage of receivers that are returned is really negligible. The only disadvantage of this method is that the dealer is

ignored and consequently no support can be expected from them, even if they realize that the Pliodyne 6 is superior to any receiver they have to offer in competition.

In the future entertainment transmitted over telephone wires will be a serious competitor to radio unless a static eliminator is discovered.

For example, suppose a particularly good Symphony Orchestra was playing in San Francisco and about one thousand people in New York wished to listen to this entertainment.

One Telephone Trunk Line from San Francisco to New York would cost \$5.50 per minute or distributed between one thousand people would cost three cents per hour each, adding to this the local charge of five cents every three minutes would amount to \$1.03 maximum for an hour's entertainment. It is assumed that the concert is picked up at the Orchestra in the usual way and forwarded direct to New York by land telephone line where it is amplified and distributed to the various telephone subscribers. The equipment at the subscriber's home would consist of an amplifier and loud speaking device. The present telephone lines would be sufficient, and arrangement could be made to enable the exchange operator to interrupt the entertainment to handle a regular telephone call if desired. If this interruption is objectional, a second telephone installation could be had for three or four dollars a month exclusively for entertainment work.

The telephone company would advertise the programs in the daily papers. A telephone subscriber would call up the operator and ask for "Radio Service" instead of Long Distance and "Radio Service" Operator would connect the subscriber with any program from any city selected. In this manner a program from any point in the United States or Canada could be enjoyed at a distance without any static disturbance or disturbances from neighboring equipments. The cost of the amplifier and loud speaking device to the subscribers would be less than the cost of an average radio set. This cost could well be assumed by the telephone company and the return from tolls would represent a very reasonable profit. Allowing a plan of this sort the night use of the telephones (which is now small compared with day use) would exceed the day tolls and at least double the revenue of the telephone companies. With a half million subscribers in New York alone, twenty-five different types of programs would allow 20,000 listeners per program.

An entertainment of national interest such as a Prize Fight, World Series Game, Harvard-Yale Football Game, Inauguration Speech, etc., would undoubtedly provide an opportunity to secure over two or three million subscribers.

The future of Transoceanic radio telegraph is also a question of interest. These high-power stations first used the "Timed Spark" System of transmission. This was discarded in favor of the "Alternator" and now it certainly looks as if the "Alternator" would be discarded in favor of the High-Power Tube System. Each time a new system is installed a very heavy loss has to be written off as depreciation. In the meantime the cable business goes merrily on at a good profit. The speed at which messages can be transmitted is much higher by cable than that possible by radio. In the near future all messages will be grouped on a large page and the entire page photographed and the photograph transmitted by cable. This will ensure absolute accuracy and increased speed. An entire newspaper page of interest could be cabled photographically in about five minutes compared with the old method requiring several hours. In the meantime while the radio can also do this it will be difficult unless static is eliminated.

In general radiotelephone will not transplant the regular telephone lines. The real place for radio communication is between ship and shore, ship and ship, either ships of the air or sea. Radiotelephone will not replace radiotelegraph for commercial purposes except to the extent that telephone has replaced the telegraph today.

Several "Power Units" are appearing on the market. These units are designed to plug in on the ordinary lighting circuit and provide "A" and "B" Battery current for any receiver.

The Super-Ducon as manufactured by Dubilier seems to be the most promising, although it must be admitted that to this writing samples have not been available for test. While undoubted these units will be satisfactory for small sets, it is a question whether the alternating current "hum" will be sufficiently suppressed for such powerful amplifying sets as the Pliodyne 6, Super-Pliodyne 9, Super-Heterodyne Models C, C-7 and C-10.

HOW LONG WILL MY "B" BATTERY LAST?

This report presents the shelf life, discharge and capacity characteristics of "B" or plate batteries classified according to battery weight in pounds. Examples are given showing how approximate service-hours may be computed for all standard combinations of tubes and batteries. Tube plate currents with various grid bias voltages are shown by curves. The effects of the number of "B" batteries, the number of tubes, the grid bias voltage, the size of "B" batteries and the type of tubes are clearly shown.

The cost of "B" battery replacements in radio receiving sets is being given serious consideration by all broadcast listeners, especially

those who are experimenting with multi-tube sets. These big sets with six or seven tubes, under some conditions, use up "B" batteries at a rapid rate and it is believed that information about the factors which affect the "B" battery service-hours and the methods of decreasing "B" battery costs will be of interest. Such information is embodied in this report.

The usual "B" battery is an assembly of fifteen small dry cells soldered together in series and sealed in a convenient non-conductive box with terminals at end cells, furnishing a voltage of about 22.5 volts. Some units have thirty cells of 45 volts, but fifteen cells is usually considered the standard for a "B" battery. Special batteries with terminals on individual cells are provided for some purposes, especially for "soft" detector tubes which have a critical "B" or plate voltage.

Sizes

"B" batteries have heretofore been designated by "large," "medium" and "small" and it has been generally understood that the largest battery would last longer than the smallest. A simpler classification is used in this report, in which the batteries are grouped according to their weights, as follows:

5-lb. Batteries—The so-called "large" Navy size of 22.5 volts, containing fifteen $1\frac{1}{4}$ in. by $2\frac{1}{4}$ in. cells assembled in block and vertical type. Two of this size are equivalent to a 10-lb. 45-volt battery.

2-lb. Batteries—Equivalent to the "medium" sized batteries, containing fifteen $\frac{3}{4}$ in. by $2\frac{1}{8}$ in. cells, assembled in block and vertical type. The actual weights of these batteries range from $1\frac{1}{2}$ lbs. to 2 lbs.

1-lb. Batteries—The so-called "small" Signal Corps battery, containing fifteen $\frac{5}{8}$ in. by $1\frac{7}{8}$ in. cells, assembled in block type.

The block batteries are flat or horizontal like building bricks the vertical batteries stand on end and occupy less table space. Whether the batteries are of block or vertical type, if they fall into any of the weight classes previously mentioned they may, in general, be considered comparable in electrical characteristics.

Electrical Rating

The United States Government, in rating "B" batteries, judges them according to the length of time they will be in service on a continuous discharge to an end voltage of 17 volts. Some manufacturers rate their batteries by the number of hours the batteries serve at a definite current. These ratings, however, are inadequate for a grade of batteries under high current conditions and this report is prepared to

present data by which the service-hours of "B" batteries can be determined under various conditions. Information on vacuum tube current drains at various plate voltages and grid bias voltages is also presented.

"B" batteries may be rated like storage batteries, in ampere-hour capacities at various ampere current rates. However, as the current drain on a "B" battery is small and usually measured in milliamperes, the rating can be made in milliampere-hours, that is, the milliampere current drain times the service in hours to a definite end voltage.

Service Characteristics

The characteristics of a "B" battery, which are of most importance to the broadcast listener, are:

- 1—Shelf or Storage Life,
- 2—Service-hours.
- 3—Noiselessness.

The shelf or storage life of a battery is its ability to retain its milliampere-hour capacity while standing idle either before use or between periods when it is in use. A good shelf life is, of course, desirable to enable the broadcast-listener to receive the maximum service from the batteries he purchases and to extend the hours of service when he is not using his batteries regularly.

The service-hours is the total time that a battery will deliver the necessary current before it must be discarded from the set as being no longer useful. High service-hours are, therefore, necessary for economical operation.

Noiselessness in a battery is a difficulty determinable characteristic and it indicates that the battery is free from minute voltage fluctuations which, by action through the tubes, cause noise in the phones. Noiselessness is a quality closely connected with the nature of the chemical mix, the cell zinc can construction and the cell insulation, and obviously a noiseless battery is to be desired.

.Shelf Life

The shelf life of a battery is determined from a study of many batteries which are regularly examined or tested at various ages. For example, batteries of various ages can be tested by different methods and the voltage or service-hours determined and the average results plotted as a curve showing the percentage of the initial value at different ages.

Curve I shows the average voltage and service-hours shelf characteristic tests on the three classes of batteries. It should be noted that

there is only a slight falling off during the first months. Inasmuch as the average "B" battery is put into service within a few months after manufacture, the broadcast-listener need not fear a serious loss due to shelf deterioration.

A good shelf life characteristic is obtained by perfect insulation between cells, which allows no internal cross currents and a resulting decrease in milliamper-hour capacity. Excessive heat during storage lowers the shelf by drying out the chemicals in the battery. Impurities in the chemicals will likewise cause the cells to lose their capacity through internal action.

Service-Hours

Service-hour tests are made by discharging batteries under various conditions, usually through a constant resistance or at a constant current rate. The latter test is made by maintaining a constant current in the battery by means of an adjustable resistance. This type test can be either continuous or intermittent with periods of rest between discharges. The intermittent test represents the service of a battery under usual broadcast-listening use.

CURVE I

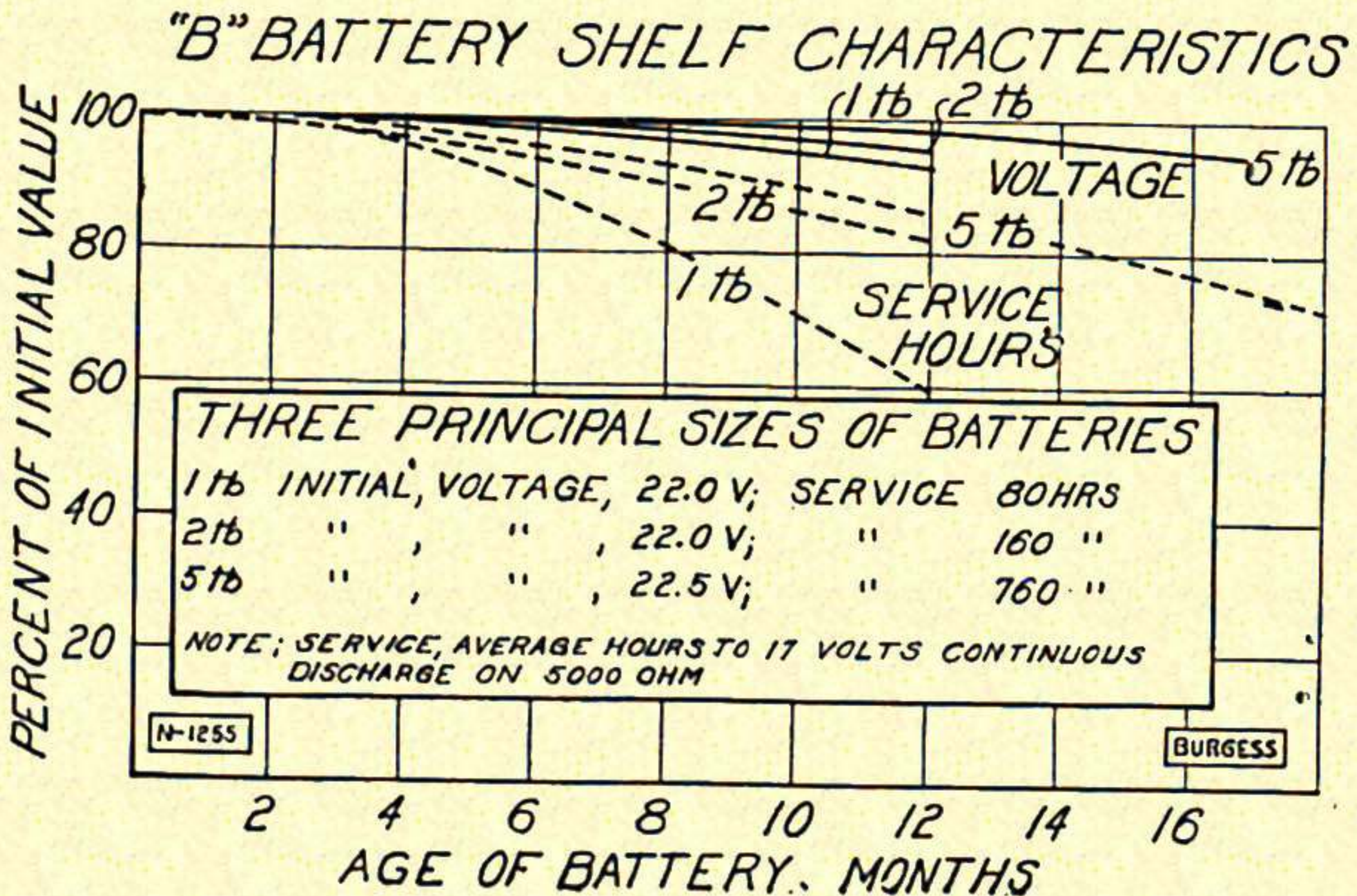

Curve II shows the characteristic discharge, at constant resistance, of a 2-lb. battery, both on continuous and intermittent discharge. It should be noted that with intermittent discharge the service-hours to a predetermined end voltage, for example, 17 volts, is almost double that with continuous discharge.

Noise

The noise characteristic is not so easily tested in the laboratory, as the small voltage fluctuations are difficult to measure with usual instruments, but the noises will make themselves noticed during the operation of a set, especially if the batteries are not properly constructed. Slow voltage fluctuations can be measured with a voltmeter but rapid fluctuations are recognized only by the action of the tube which causes a variation in the phone current and, therefore, noise. That there is a voltage fluctuation in small sized dry batteries is frequently shown by flash light batteries in flash light cases, when the light sometimes actually flickers.

Constant Current Discharge

Curve III shows the discharge characteristics of a 5-lb. battery at various constant currents. The milliampere-hour capacity at any of these rates would be the service-hours times the current.

CURVE II

"B" BATTERY CONSTANT RESISTANCE DISCHARGE CHARACTERISTICS

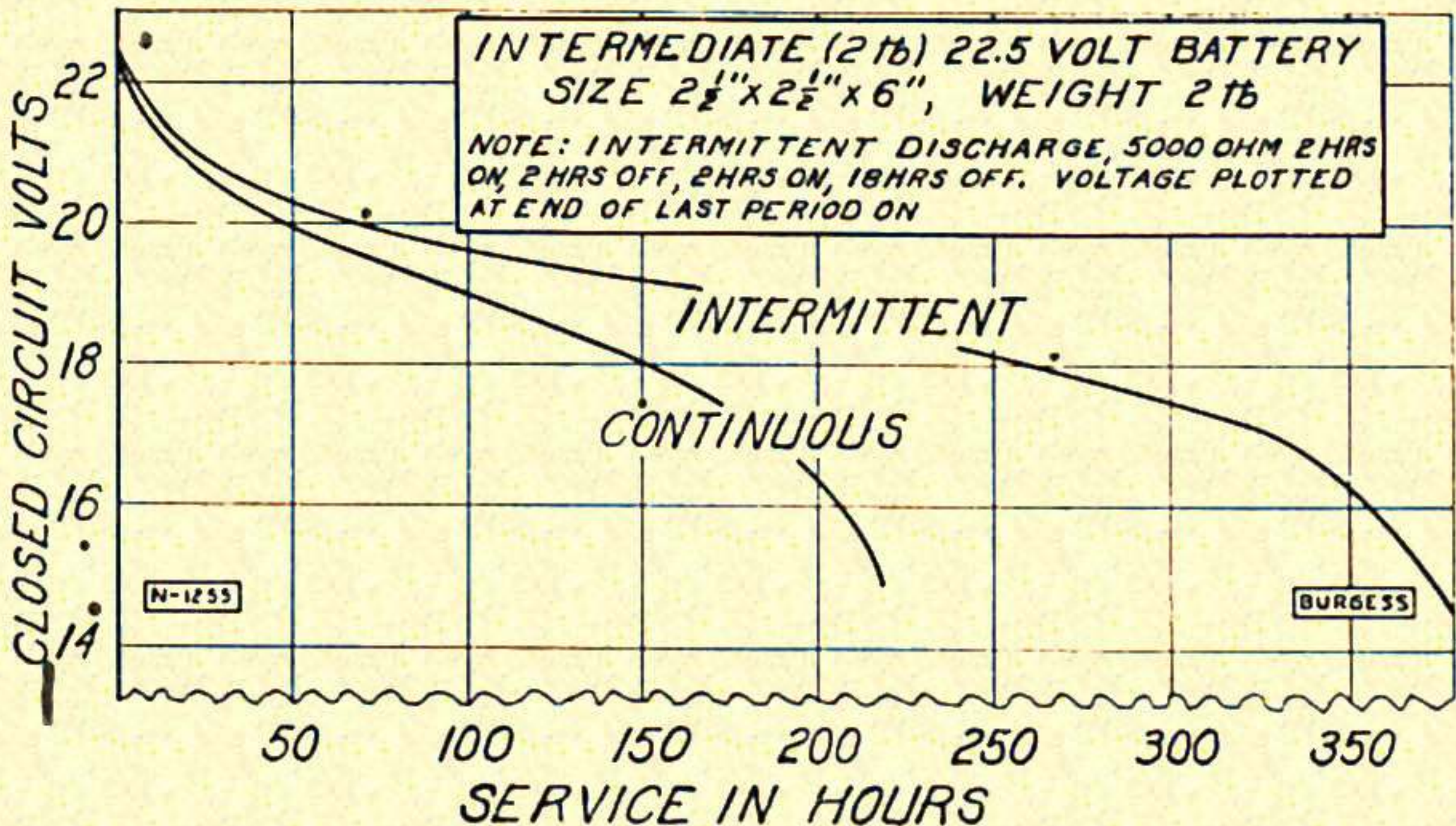

Inasmuch as the general use of "B" batteries is on intermittent service, the capacity on intermittent discharge should be chosen as representing a rating for radio purposes. The usual end voltage per battery is 17 volts because under this voltage the tubes do not always function satisfactorily.

Milliampere-Hour Capacities

Curve IV is plotted from the results of many determinations of milliampere-hour capacity, and this gives the milliampere-hour capacity of the three sizes of batteries at various currents to an end voltage of 17 volts per battery on a discharge of four hours per day, the discharge being two hours on, two hours off and two hours on.

This curve shows that there is an increase of capacity with a decrease in the current drain and also with an increase in the size of the battery. To estimate the service-hours of batteries on various tubes it is necessary to know the average working voltage of the batteries as it drops from the initial value to the end point of 17 volts. By referring to Curve III it is seen that the average working voltage may be considered as the average between 22 volts and the end voltage of 17 volts, that is,

CURVE III

"B" BATTERY CONSTANT CURRENT DISCHARGE CHARACTERISTICS

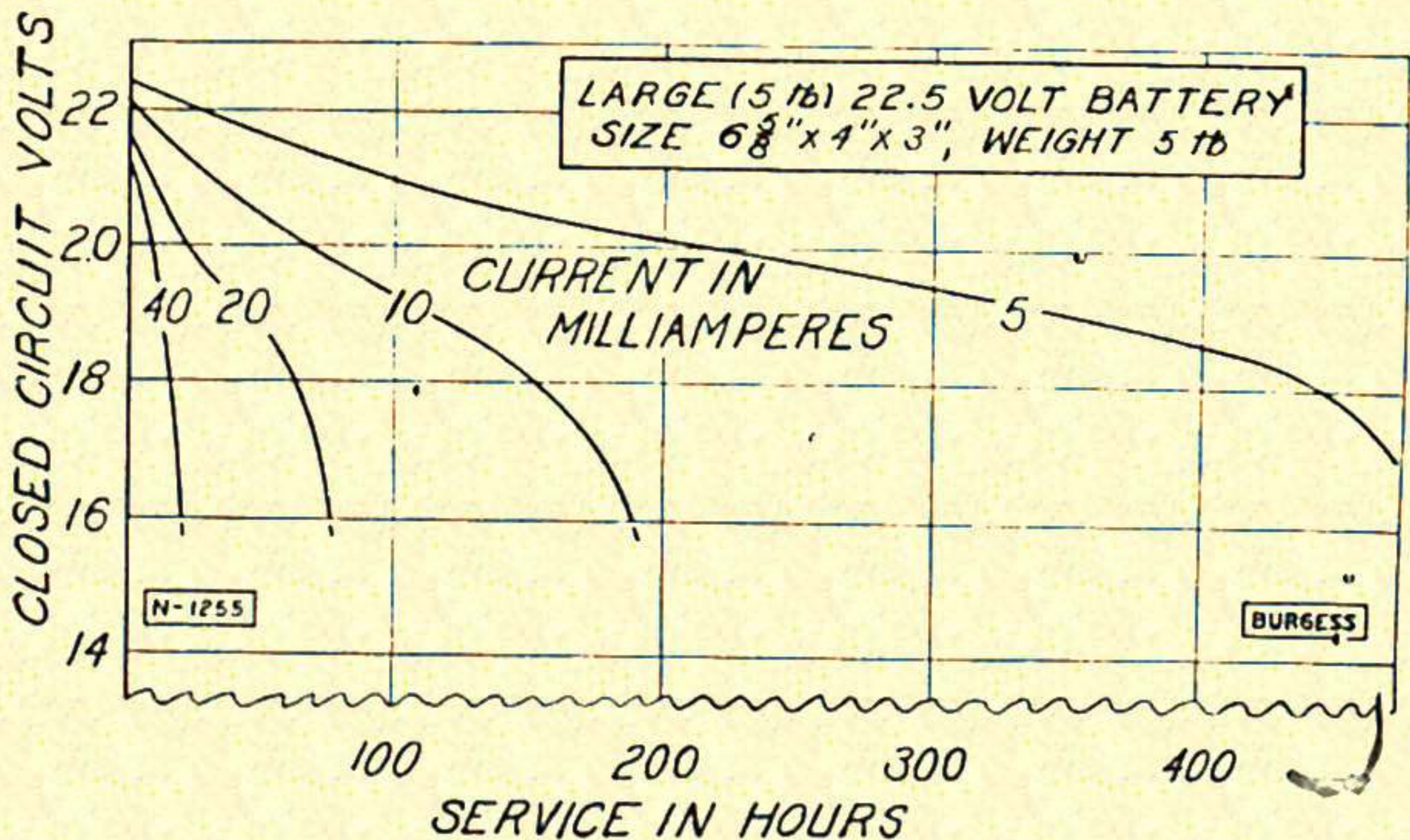

the average working voltage of one battery dropping to 17 volts is 19.5 volts.

Vacuum Tube Plate Currents

Curve V shows the average "B" battery current drain for a UV-201-A tube at various plate voltages and with various grid bias volts. For convenience, the average working voltages of various numbers of "B" batteries are indicated.

Curve VI shows similar information for the UV-199 and WD-12 tubes. This curve is prepared on the assumption that the characteristics of both tubes are the same, although this is not actually the case. There is as much variation in tubes of the same type as between types and the average of the two types, which is here indicated, may be assumed approximately correct.

Expected Service-Hours

To determine the expected service-hours of a "B" battery it is only necessary to divide the milliampere-hour capacity at the current drain of the tubes by the current drain itself. A number of typical examples showing the effect of the various factors of receiving set hook-ups are shown by the following examples.

Example: To show effect of the number of "B" batteries.

Receiving set with:

Two UV-201-A, radio amplifier tubes, no grid bias.

One UV-201-A, detector tube with 22.5 volts (one "B" battery).

Two UV-201-A, audio amplifier tubes, no grid bias.

To determine the approximate service-hours with various numbers of 5-lb. batteries on amplifiers:

I.—Three batteries (initial 67.5 volts).

II.—Four batteries (initial 90.0 volts).

	I Three	II Four
Number of "B" batteries.....	Three	Four
Radio amplifiers		
Current from Curve V.....	2.0	3.7
Total for two	4.0	7.4
Detector		
Current from Curve V.....	0.3	0.3
Audio amplifiers		
Current from Curve V.....	2.0	3.7
Total for two	4.0	7.4
	—	—
Total "B" battery current, milamps.....	8.3	15.1

CURVE IV

"B" BATTERY MILLIAMPERE-HOUR
CAPACITY CHARACTERISTICS

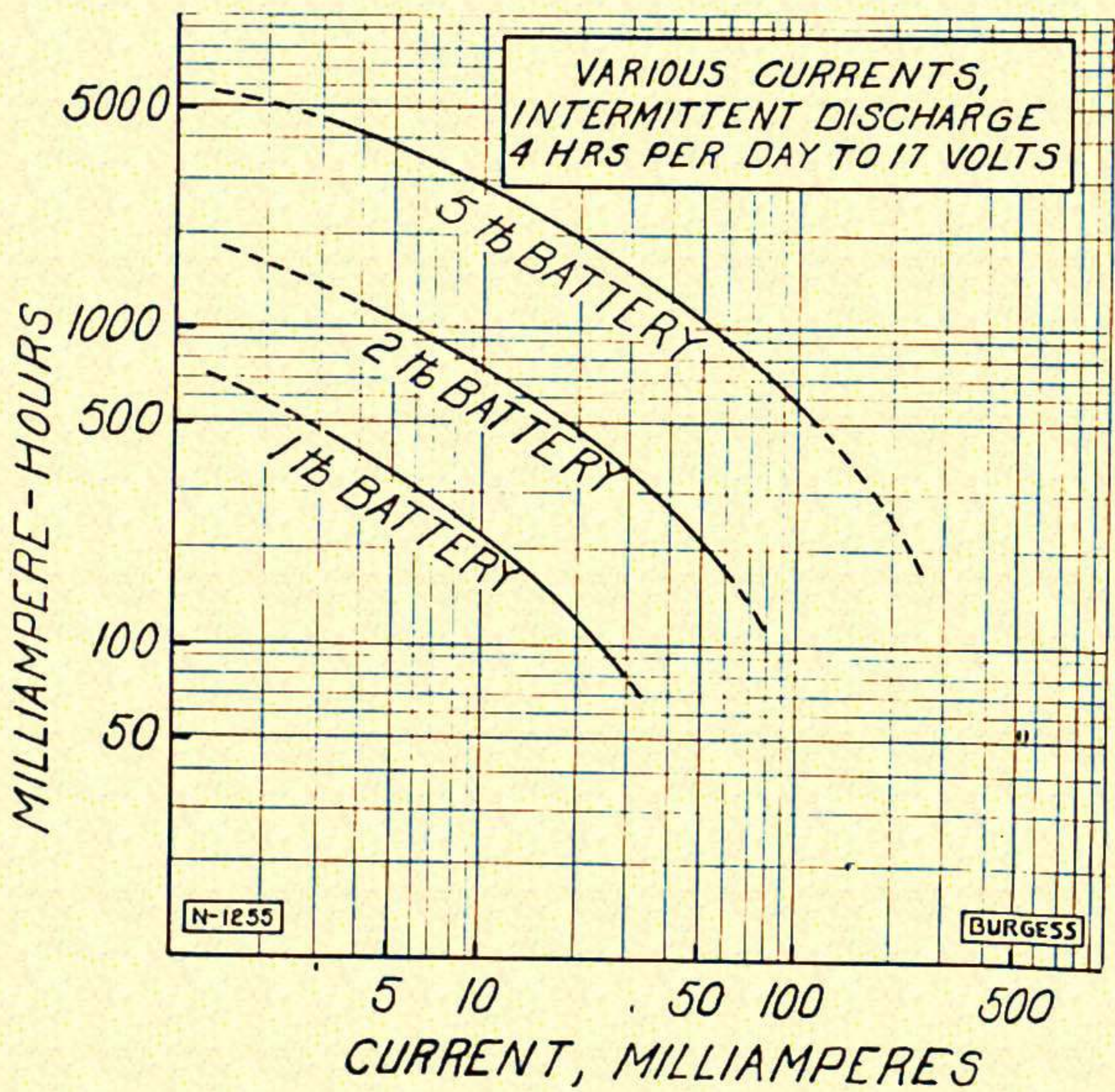

Milampere-hour capacity at above current 5-lb. batteries, Curve IV	3,100	2,300
Service-hours (milamp. hr. ÷ milamp.)	373	153
Cost of batteries at \$2.50 each	\$7.50	\$10.00
Costs in cents per hour of service.....	2.01c	6.54c

Example: To show the effect of the number of tubes.

Receiving set with:

I.—One UV-201-A, detector tube with 22.5 volts (one "B" battery).
Two UV-201-A, audio amplifier tubes, no grid bias. Four batteries.

II.—Two UV-201-A, radio amplifier tubes, no grid bias.
One UV-201-A, detector tube with 22.5 volts (one "B" battery).
Two UV-201-A, audio amplifier tubes, no grid bias. Four batteries.

To determine the approximate service-hours with various number of UV-201-A tubes:

I.—Three tubes (detector, 2 audio amplifiers).
II.—Four tubes (2 radio amplifiers, detector, 2 audio amplifiers).

	I	II
Number of UV-201-A tubes	Three	Four
Radio amplifiers		
Current from Curve V.....		3.7
Total for two		7.4
Detector		
Current from Curve V	0.3	0.3
Audio amplifiers		
Current from Curve V	3.7	3.7
Total for two	7.4	7.4
	—	—
Total "B" battery current, milamps	7.7	15.1
Milampere-hour capacity at above current 5-lb. batteries, Curve IV.....	3,300	2,300
Service-hours (milamp.-hours ÷ milamps.)...	428	153
Cost of batteries at \$2.50 each.....	\$10.00	\$10.00
Cost in cents per hour of service.....	2.34c	6.54c

Example: To show effect of grid bias voltage on audio amplifier tubes.

Four "B" batteries.

Receiving set with:

CURVE V

VACUUM TUBE CHARACTERISTICS
No. 201-A

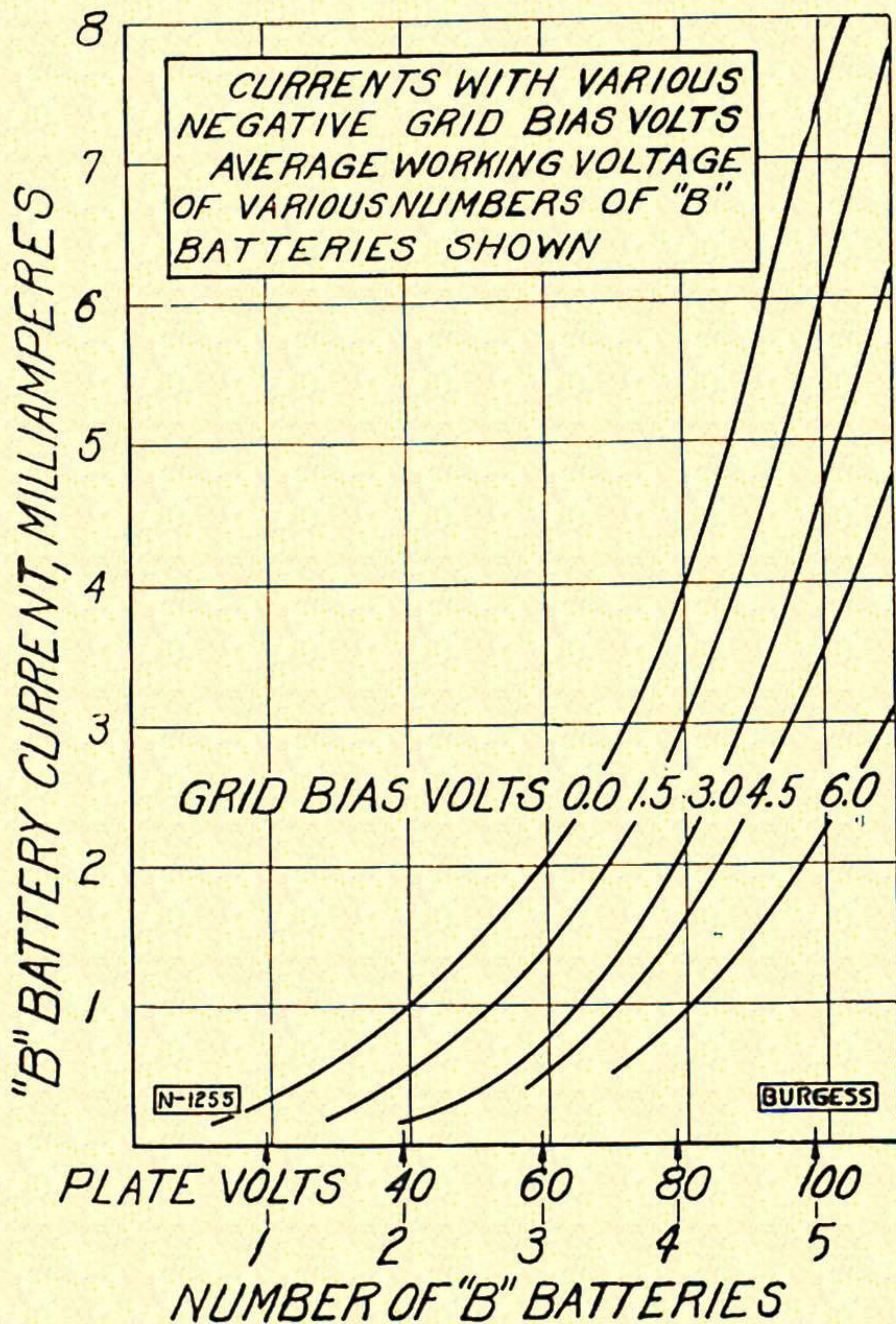

CURVE VI

VACUUM TUBE CHARACTERISTICS

Nos. UV-199, WD-12

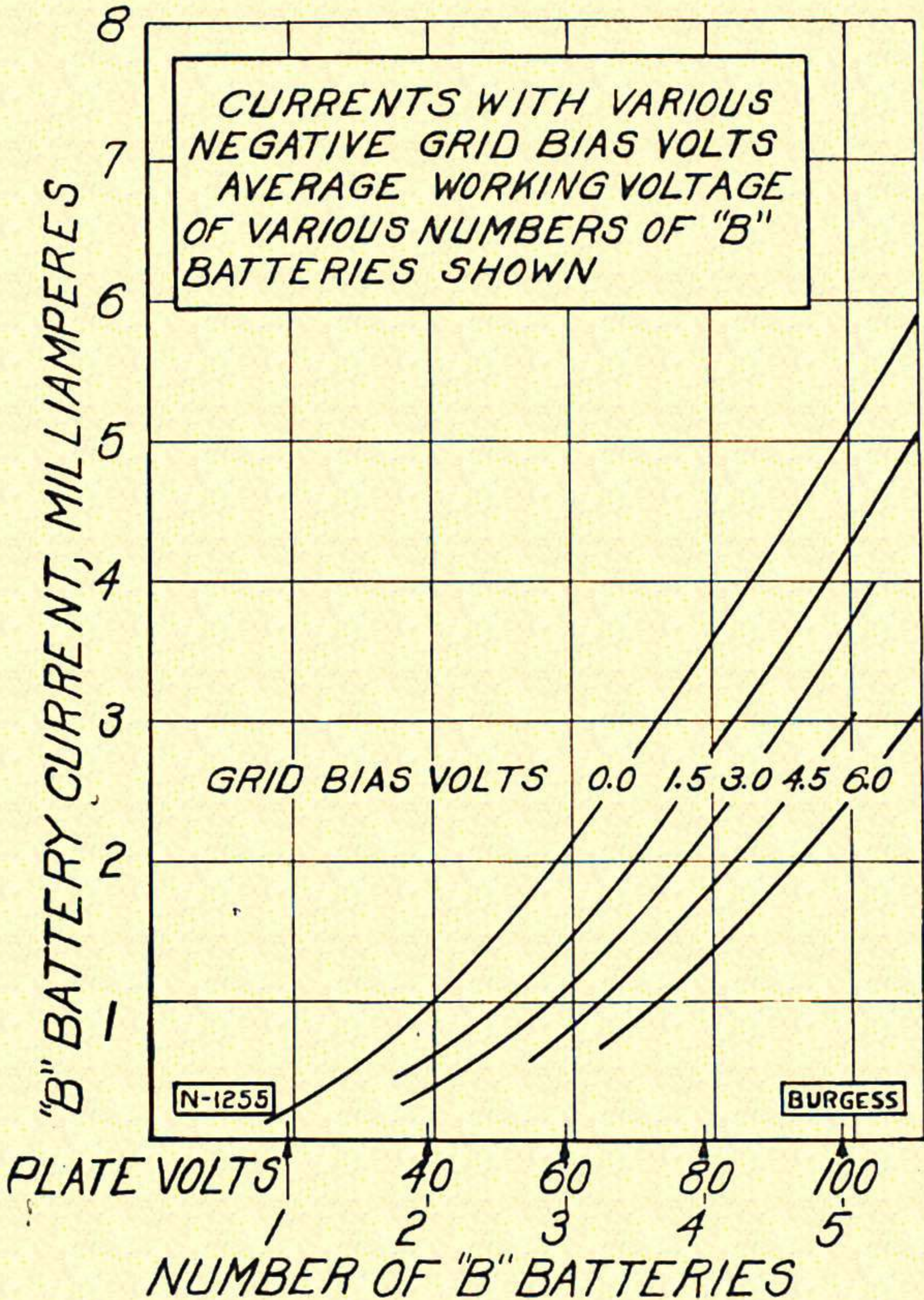

- I.—Two UV-201-A, radio amplifiers tubes, no grid bias.
 One UV-201-A, detector tube with 22.5 (one "B" battery.)
 Two UV-201-A, audio amplifier tubes, no grid bias. Four "B" batteries.
- II.—Two UV-201-A, radio amplifier tubes, no grid bias. Four "B" batteries.
 One UV-201-A, detector tube with 22.5 (one "B" battery).
 Two UV-201-A, audio amplifier tubes, 4.5-volt grid bias. Four "B" batteries.

To determine approximate service-hours with no grid bias and with 4.5-volt grid bias:

	I	II
Amount of grid voltage on radio amplifier....	0.0 volts	4.5 volts
Radio amplifiers		
Current from Curve V	3.7	3.7
Total for two	7.4	7.4
Detector		
Current from Curve V	0.3	0.3
Audio amplifiers		
Current from Curve V	3.7	1.5
Total for two	7.4	3.0
	—	—
Total "B" battery current, milamps.....	15.1	10.7
Milampere-hour capacity at above current 5-lb. batteries, Curve VI	2,300	2,800
Service-hours (milamp.-hours ÷ milamp.)....	153	262
Cost of batteries at \$2.50 each.....	\$10.00	\$10.00
Cost in cents per hour of service.....	6.54c	3.82c

Example: To show the effect of battery size.

Receiving set with:

- I.—One UV-199, detector tube with 22.5 volts (one "B" battery).
 Two UV-199, audio amplifier tubes, 4.5-volt grid bias. Three 5-lb. batteries.
- II.—One UV-199, detector tube with 22.5 volts (one "B" battery).
 Two UV-199, audio amplifier tubes, 4.5 grid bias. Three 2-lb. batteries.
- III.—One UV199, detector tube with 22.5 volts (one "B" battery).
 Two UV-199, audio amplifier, tubes, 4.5 grid bias. Three 1-lb. batteries.

To determine the approximate service hours of the 5-lb., 2-lb. and 1-lb. class of "B" batteries.

	I	II	III
Class of "B" batteries	5 lb.	2 lb.	1 lb.
Detector			
Current from Curve VI	0.2	0.2	0.2
Audio amplifiers, with 4.5-volt grid bias			
Current from Curve VI	0.8	0.8	0.8
Total for two	1.6	1.6	1.6
Total "B" battery current, mil-amps.	1.8	1.8	1.8
Milampere-hour capacity at above current, Curve IV	5,100	1,700	600
Service-hours (milamp.-hours ÷ mil-amp.)	2,833	945	333
Cost of batteries	$\left\{ \begin{array}{l} 5 \text{ lb. @ } \$2.50 \\ 2 \text{ lb. @ } 1.90 \\ 1 \text{ lb. @ } 1.50 \end{array} \right\}$		
Cost in cents per hour of service	0.26c	0.60c	1.35c

Example: To show the effect of the kind of tubes.

Receiving set with:

I.—One UV-201-A, detector tube with 22.5 (one "B" battery).

Two UV-201-A, audio amplifier tubes, no grid bias. Four batteries.

II.—One UV-199, detector tube with 22.5 (one "B" battery).

Two UV-199, audio amplifier tubes, no grid bias. Four batteries.

To determine approximate service hours with various kind of tubes:

	I	II
Kind of tube	UV-201-A	UV-199
Number of tubes	Three	Three
Detector		
Current from Curves V and VI	0.3	0.2
Audio amplifiers		
Current from Curves V and VI	3.7	3.5
Total for two	7.4	7.0
Total "B" battery current, milamp.	7.7	7.2

Milampere-hour capacity at above current 5-lb. batteries, Curve IV.....	3,300	3,500
Service-hours (milamp.-hours \div milamp.).....	429	486
Cost of batteries at \$2.50 each.....	\$10.00	\$10.00
Cost in cents per hour of service.....	2.33c	2.06c

Summary

Summarizing these data it is seen that to obtain the maximum service-hours of "B" batteries the following conditions should be attained:

- 1—Smallest possible number of "B" batteries,
- 2—As few tubes as are necessary,
- 3—A grid bias voltage on amplifiers,
- 4—Largest possible size "B" battery,
- 5—Low plate current drain tubes, (This factor is not of prime importance as there is small difference in current drain of tubes.)

Effect of Shelf Life

The shelf life of batteries is a determining factor where the service-hours are extended. By referring to Curve 1 it is seen that the 5-lb. battery may be expected to function for eighteen months, while the smaller sizes will have a life of twelve months. Many cases are known where the battery life extended beyond these periods but in general the batteries may be expected to be replaced at the end of their periods, even if their milliamper-hour capacity has not been exhausted.

Rotating Batteries Between Tubes

In the examples previously mentioned the current from the detector tube, which usually operates at a lower voltage than the total amplifier voltage, is assumed as flowing through the entire "B" battery set. In other words, the batteries are estimated as operating at a higher current drain than is actually the case and their service-hours will be greater than estimated. It is suggested that when the total hours of service have reached the computed value that the broadcast-listener remove his detector battery and replace it by one which has been on the amplifier circuit. If later the signals begin to fade this battery can be removed to the amplifier set and replaced by another which has not been on the detector. The battery service then is distributed between all of the batteries and it is estimated that from 10 per cent to 20 per cent more service-hours can be obtained than that computed in the foregoing examples.

As fifteen cell batteries can be more easily exchanged from amplifiers to detectors it is always advisable to use 22.5 volt instead of 45 volt batteries.

LETTERS GIVING RESULTS OBTAINED FROM
DESIGNS BY THE WRITER

McMinnville, Tenn.,
Box 353,
December 21, 1923.

Experimenters Information Service,
476 Broadway,
New York City.

Gentlemen:

I am still getting wonderful results with my Model "C" Super. KHJ on Loud Speaker using a loop, Mexico City, etc. Hope to get a Model "J" Amplifier to put in front of it soon. Please send me dope on the Model "J" Radio Frequency Amplifier.

Yours very truly,

Signed W. H. WILSON.

Lake Villa, Ill.,
October 1, 1923.

Experimenters Information Service,
476 Broadway,
New York City.

Gentlemen:

My Super-Heterodyne Model "C" working fine. Can't be beat. Firpo-Dempsey fight from New York on Western Electric Loud Speaker first stage.

Yours truly,

Signed G. M. SHERLEY,
c/o J. K. Dering,
Lake Villa, Ill.

Newport, R. I.,
December 3, 1923.

Experimenters Information Service,
476 Broadway,
New York City.

Gentlemen:

No doubt, you will be interested to know that last week I was successful in picking up 2-LO London on Sunday, Tuesday and Saturday nights, and it is needless for me to say that I was very proud of my accomplishment. I thought you would be interested to know this, as it was accomplished on one of your older types of resistance coupled Super-Heterodyne sets.

As far as I know, I was the only one in Newport able to pick them up and from present information available the only one in Rhode Island.

Very truly yours,

Signed KARL BOSTEL

THE I. SULZBACHER COMPANY, INC.
Steubenville, Ohio

April 12, 1924.

Messrs. The Experimenters Information Service,
476 Broadway,
New York City.

Gentlemen:

While unfamiliar with the experiences others have had with your Model "C" Super-Heterodyne and "J" Unit ahead, the undernoted reception strikes me as being entirely beyond the capabilities of any other receiver on the market, and I have tried most all of them.

Without antenna or ground connection, and without using a loop aerial of any sort, stations in the following cities were brought in the other evening and could be heard fifty feet from the 10 D Western Electric Loud-speaker:

New York,
Springfield,
Pittsburgh,
Chicago,
Atlanta,
Kansas City.

I make no mention of what can be done with a good loop or outside antenna, the above surely indicates the most remarkable qualities of the outfit.

Yours truly,

Signed JAMES W. HITCHCOCK.

THE ANDERSON LUMBER COMPANY
Passaic, N. J.

February 27, 1924.

Experimenters Information Service,
476 Broadway,
New York City.

Gentlemen:

I have been the owner of a Super-Heterodyne Model "C" for the past two months and last evening I received what I consider a very excellent, select reception by drawing station WQAN, Miami, Florida, on the loud speaker, with but one stage of audio. This, I believe, is wonderful, due to the fact that WHN was broadcasting at the same time and, as you no doubt know, they broadcast on the same wave length and same watt station as Miami.

I can also say that with this particular receiver I have very little trouble in drawing California, bringing in the Western coast continuously on my set markings of dials.

Yours very truly,

Signed W. C. BOWMAN.

Crystal City, Mo.,
5/12/24.

Experimenters Information Service,
476 Broadway,
New York City. •

Gentlemen:

I thought you might be interested in the results I am getting with my Models "C" and "J." I have received both Coasts—Springfield, Mass., and New York to Oakland, California, using a loop and a loud speaker on detector or at most one stage of audio *without any connection whatever (No Loop, aerial or ground)*. I have received Hastings, Pittsburgh and Fort Worth and many stations in between, all on loud speaker and one audio. This gives fine reception during storms.

I am very well satisfied with quality of tone, volume and distance and believe I have an outfit that would be very hard to beat.

Yours truly,

Signed Wm. R. McKOWN,
Crystal City, Mo.

DR. WALTER A. WARFIELD
908 Cameron St.
Alexandria, Virginia

April 8, 1924.

Experimenters Information Service,
476 Broadway, New York City.

Dear Sirs:

I beg to acknowledge receipt of Super-Heterodyne Radio Parts. I wish to say that the set is working perfectly, and I have recorded every station in the U. S. and Canada. Owing to my lack of experience, I do have a little trouble in using the loop. Do you think if I used the outside aerial with your tuning device that I will get longer distance? Also your candid opinion about the added R. F. This set is causing a lot of pleasing comment and I have had nearly everyone in this town interested in this set. I am specially anxious to see many of my friends here get this set instead of buying the many cheap and unsightly ones that are on the market. The Radio Corporation have just sent one of their Supers here for sale, and there is no comparison. I will be glad to send you the names of many friends that are interested, if you desire.

Yours very truly,

Signed W. A. WARFIELD.

FLORENCE WATERS
P. O. Box 358
Clarksdale, Miss.

May 16, 1924.

Experimenters Information Service,
476 Broadway,
New York City.

Gentlemen:

It has been my pleasure to use one of your Model "C" Super-Heterodyne Receivers for the past 18 months. I have just purchased the Radio Corporation of America's new portable Super-Heterodyne, also one of their Super VIII. There is as much difference in the reception of signals with these two receivers as there is between the Super and the old straight regenerative circuit.

I would not be willing to part with my Model "C" if I could not secure another one for any price.

Hoping this may be of interest to you, I am.

Yours very truly,

E. J. MULLENS, JR.,
Signed by F. Florence.

Detroit, Mich., June 11, 1924.

Experimenters Information Service,
476 Broadway,
New York City.

Gentlemen:

Wish to advise you that I have just constructed one of your Model "C" Super-Heterodyne Receivers with the exception of wiring in the Audio Frequency Transformers.

I have tested out the circuit up to the Detector jack, which is as far as my wiring is complete, and it is beyond me to express in words my appreciation and satisfaction in the results obtained at this time of the year.

Using a three-foot loop, that is a loop which measures three foot square, which I had hurriedly constructed the other night of available material around the house, and by piecing what wire I could scrape together at the time I managed to get six turns on it, which loop I intended to use for a test purpose only. I then proceeded to tune in the local station WWJ, which was broadcasting at the time. For a period of about 15 minutes I turned the dials of the condensers and rheostats, but the set did not even "Perk." However, I recalled that I had failed to place a connection link across the binding posts in the upper left-hand corner of the cabinet. This took but a moment and

I got back again at the dials. A partial turn of the condenser dial (I do not remember which one) and the station came in too loud to be comfortable with the phones on. I then laid the phones on the table and we could hear the broadcast all over the house, with the phones connected into the detector jack. We waited for the announcement, which came shortly, but to our surprise not WWJ, but instead broadcasting station located at Springfield, Mass. I have built quite a number of sets for myself and friends and have also listened to quite a number of manufactured outfits, but this Model "C" surpasses anything that I have heard for perfect broadcast reception, and I expect when it is fully completed according to your specifications it will have a few more surprises in store for me.

Yours very truly,

Signed BERT SMITH,
c/o Standard Oil Co.,
1011 4th Avenue,
Detroit, Mich.

Arequipa, Peru, March 17, 1924.

Experimenters Information Service,
476 Broadway,
New York City.

Gentlemen:

You will be pleased to learn that the 10-tube set parts that I bought from you last year has been producing lately some remarkable results, after vainly trying for results in Arequipa itself I took the set out to the Power Station located about 10 miles from the city in a very deep canon, the operator there had set up an aerial stretching 120 meters across the valley and with a vertical lead in 100 meters high, using this we have been getting the following stations:—

Montevideo,
Rio Janeiro,
Mexico City,
Davenport, Iowa,
WGY—Schenectady,
WJZ—New York,
Drake Hotel, Chicago.

The above to recognize the call letters and to be perfectly sure of their identity, in addition we can pick up dozens of others, but so far have not recognized any calls.

Static continues bad, but music can be enjoyed and 75% of the words can be understood.

It is evident that my previous failure to get across was due to the proximity of the aerial to trolley and lighting lines, as it is inconvenient to have the set 10 miles away, I would appreciate your sending me directions for putting up an aerial which would be satisfactory under conditions where trolley and lighting lines (50 cycle) would be within 100 yards of the aerial.

Yours very truly,

Signed L. ANCIRUX.

EUGENE EVAN GEORGE
50 Congress St.
Boston

October 31, 1923.

Experimenters Information Service,
476 Broadway,
New York City.

Gentlemen:

I am tired (just think of it) of hearing KHJ and others on the Models "C" and "J."

Yours very truly,

Signed EUGENE EVAN GEORGE.

S. S. ~~RESOLUTE~~

UNITED AMERICAN LINES
Incorporated

OPERATING DEPARTMENT
39 Broadway, New York.

S. S. *RESOLUTE*
New York, June 1, 1924.

Experimenters Information Service,
476 Broadway,
New York City.

Subject: Super-Heterodyne testimonial.

1. Used 7-tube Super-Heterodyne on "Round the World Cruise" on S. S. *Resolute*, Jan. 19th to May 24th.
2. On night of April 27th after leaving Suva, Fiji Islands, picked up KGO Oakland, Calif., broadcasting from St. Francis Hotel, San Francisco, distance 4662 miles. Signals heard five feet from phones. Static heavy. Signals consistent. Heard California stations all through South Sea Islands. Other stations in, but static too heavy to determine origin.
3. On morning May 13th, 6:30 A.M. Pacific time, picked up VIS Sydney, Australia (600 meters spark) distance 6330 miles. Signals easily copied with phones on desk (Latitude 0 degrees 49 minutes North. Longitude 108 West). VIS working ship station.
4. The above are extracts from our log of greatest distance in receiving broadcast and 600 meter spark stations.

Signed GEORGE MARTIN

2nd Radio Officer,
S. S. *RESOLUTE*,
c/o U. A. L.,
39 Broadway, N. Y. C.

PRATT & BRAKE CORPORATION
501 Fifth Avenue, New York.

April 30, 1924.

Experimenters Information Service,
476 Broadway,
New York City.

Gentlemen:

You will recall the sale to Mr. Norman Pratt, for Pratt & Company, Buenos Aires, and will be pleased to learn that they have sent us a complete program which was received on one of these sets in Buenos Aires, Argentina, from Station KDKA on the night of the 3rd to 4th of April, that is we believe a distance of some 7,000 miles.

Yours very truly,

PRATT & BRAKE CORPORATION
Signed H. G. BRAKE,
Secretary & Treasurer.

HGB/McL

Kerrville, Texas.
7/28/24.

Experimenters Information Service,
476 Broadway,
New York City.

Gentlemen:

My Model "C" Super-Heterodyne is now reconstructed and it surpasses anything I have yet heard. I am well satisfied with my purchase.

I am however more than satisfied with the assistance and service you have rendered me in my small difficulties in the construction of the set, and thank you for the same. Regret having been forced to call on you so much for aid, but there was no one here I could call on for help.

Yours very truly,

Signed Phil H. Stricker.

THE DOMINION
Monday, April 14, 1924.
WELLINGTON, NEW ZEALAND
WIRELESS WONDERS

American Music on an Indoor Aerial

Possibly a New Zealand, and also an Australian, long-distance record for an indoor loop aerial was established last evening by Mr. I. M. Levy, of Wellington, who, operating an eight valve Super-Heterodyne set, picked up dance music from the General Electric Company's station, KGO, at Oakland, California. The music came in on a loud-speaker, so that it could be heard all over the house. During a cessation of the music, Mr. Levy re-tuned his set, using head phones and heard the announcer in America state that the music was being transmitted from the Hotel St. Francis, and the dance music was by the jazz orchestra under the conductorship of Henry Halstead. The announcer then stated that KGO was signing off. He gave the Pacific Coast time which sounded like 1.2½ a.m. The Wellington time was about 8:33 p.m. The station then shut off its wave.

561 Fifth Avenue,
Astoria, L. I.
March 3rd, 1924.

Experimenters Information Service,
476 Broadway,
New York City.

Gentlemen:

I have been operating my Model C for the past 30 days. The first week I had the set I thought it was rotten and no better than a one tuber. I could get no DX whatsoever. I phoned you and kicked like a steer. You told me to be patient until I learned how to tune the set. So I kept at it for another week, and the DX started to roar in.

In the next paragraph is a list of the stations that I have received in the past two weeks. They speak for the set much louder than I will ever be able to speak.

2LO	ENGLAND	WJAZ	ILLINOIS
WKAQ	PORTO RICO	WDAP	ILLINOIS
WGY	NEW YORK	WGL	PENNSYLVANIA
KYW	ILLINOIS	KDKA	PENNSYLVANIA
WOO	PENNSYLVANIA	WAAM	NEW JERSEY
WBZ	MASSACHUSETTS	WSAJ	PENNSYLVANIA
WIP	PENNSYLVANIA	WCAP	DISTRICT OF COLUMBIA
WOR	NEW JERSEY	WSAI	OHIO
WRG	NEW YORK	WDAF	KANSAS
WSB	MASSACHUSETTS	KFIV	KANSAS
PWX	CUBA	KFKB	KANSAS
WMAK	NEW YORK	WBAO	ILLINOIS
WLW	OHIO	WL2	OHIO
WDAR	RHODE ISLAND	WTAR	VIRGINIA
WJAX	OHIO	WBT	NORTH CAROLINA
WCAD	ILLINOIS	WBAG	FLORIDA
WBAP	TEXAS	1AXE	MAINE
6KW	CUBA	2SY	NEW JERSEY
WBS	NEW JERSEY	WCAK	TEXAS
WNAG	MASSACHUSETTS	WRC	DISTRICT OF COLUMBIA
WEAN	RHODE ISLAND	WHAA	IOWA
WSAP	NEW YORK	WOI	IOWA
WHAZ	NEW YORK	WOC	IOWA
8AK	OHIO	KFKX	NEBRASKA
KFAF	COLORADO	WTAY	ILLINOIS
WCBB	OHIO	ACX	LOCATION UNKNOWN
WHK	OHIO	KPO	CALIFORNIA
KLX	CALIFORNIA	WMAQ	ILLINOIS
WCE	MINNESOTA	KFBE	CALIFORNIA
KFFR	NEVADA	KZN	UTAH
KDZQ	COLORADO		

The stations with only 10 watts of power come in like WEA. I have copied over 100 "Ham" stations on 200 meters and less. Also the ship stations come roaring in whenever you want them. When I picked up 2LO, London, England, I thought at first it was one of the second district boys testing their set. But what I could not understand about it was that they were broadcasting music, which is against the law. A day later I was in a radio store and asked about it. They informed me: "Why, you poor nut, that is London, England." Here's hoping that some day I will find out where ACX and CYL are located.

Wishing you continued success,

I am, yours truly,

(Signed) J. TORRES.

At night the set has a continuous range of over 1,250 miles, and in the day I can work stations up to 250 miles.

March 8, 1924.

Radio Corporation of America,
Broad-Cast Central,
33 West 42d Street,
New York City.

Dear R. C. A.:

Confirming phone to you last evening, will state that at about 10:30 P.M. picked up WJZ on Neutrodyne, F. E. Set. After listening to explanation of what was being attempted, it was decided to follow you across the Continent. When the program started we picked up WGY on a ten-tube Super-Heterodyne Set—different aerial, set in another room. Could stand in doorway and hear WJZ and WGY. Of course the two loud speakers were simultaneous. Then moved on to KDKA on the Super-Heterodyne. Same effect. Then to KFXX. Same effect. Then to KGO and we have seven witnesses that heard WJZ travel some six thousand miles to Oakland and back. An approximate difference of about 1-30,000 of a second in time was not appreciated by the ear, for the two loud speakers were working simultaneously. When General Harbord announced that WJZ was being rebroadcasted in England, I called up your station to get the wavelength of 2 A. C. and tuned in on 200 plus. While we could get, and identify, what was going on from WJZ, we could not get it clearly. This was all on loud speakers.

It was a most enjoyable evening and I thank WJZ, but you have no business to pull off such an epoch-making event without giving your admirers due notice in the program.

You will please do me a personal favor by not mentioning the writer's name, as we desire no advertising.

Sincerely,

CHAS. W. RIENER
118 Grand Ave.
Tower City, Pa.

June 12, 1924.

Experimenters Information Service,
476 Broadway,
New York City.

Gentlemen:

Enclosed find photographs of Super-Heterodyne Radio built by me a few weeks ago. I am getting very good results with same.

On June 3, 1924, I tuned in Portland, Oregon; there was a great deal of static, but nevertheless I had them. I thought this might be of interest to you to know the results I am securing.

Yours respectfully,

Signed CHAS. W. RIENER.

P. S. Some nights I use a small coil of bell wire for an antenna. I put the coil in a drawer in my radio table and close it, but get Springfield, Pittsburgh, Schenectady, Louisville, etc., very good and clear.

August 5, 1923.

Experimenters Information Service,
476 Broadway,
New York City.

Gentlemen:

Your favor of the 3rd at hand, I will be much pleased to receive the blue prints of the Improved Model "L" Heterodyne, as I am going to try my luck at building that set. The Model "C" which I recently constructed is all that is claimed for it. I have brought Cleveland, Chicago and Louisville, Ky., in on the loud speaker fine. I find that the more practice I have in tuning the better the set is.

I want to caution all who inquire of me about this set that they *must not* substitute apparatus for that specified by the designers.

Yours very truly,

Signed HARRY R. NOLL,
2035 South 57th Street,
Philadelphia, Penna.

Ste-Croix, Lotbiniere, P. Q., Canada,
February 11, 1924.

Experimenters Information Service,
476 Broadway,
New York City.

Dear Sirs:

The Model "C" Super-Heterodyne, the parts of which I purchased six months ago through you, and assembled by me, has done all that has been claimed for it.

The results are wonderful.

I am 30 miles West of Quebec City, Canada, Longitude 71° 44' 8" and Latitude 46° 37' 32", 600 miles from New York.

Sometimes KDKA came in very plainly without antenna, Ground or Loop, through my Herald Phone. The range of my Super-Heterodyne is not less than 3,000 miles.

I would like to try your Model "J" in conjunction with my "C." Please let me have specifications and blue prints.

Yours very truly,

L'ABBE L. M. DESTROISMAISONS.

McComb, Miss., Sept. 27, 1924.

Experimenters Information Service,
476 Broadway,
New York City.

Gentlemen:

I want to say that the Model "C" is the king of Receivers in this town and I run it over the Radiola Super-Heterodyne so far that they are ashamed to talk about comparison. I pick up KDKA without ground or loop or aerial with loud speaker volume to hear a block away. This must be 1,000 miles air line from McComb, Mississippi, with a wire 20 feet in length under the carpet on the floor and using the Model "K" Adapter I get KGO and KPO, plenty volume to dance by.

Yours respectfully,

Signed H. H. McGEHEE,
432 South Boulevard St.,
McComb, Mississippi.

PRESENTATION RECTORY
758 S. Springfield Ave.
Chicago, Illinois

May 15, 1924*

Experimenters Information Service,
476 Broadway,
New York City.

Gentlemen:

Sincere congratulations! Since rebuilding my Receiver, it works like a charm. For

selectivity and consistency of action, it is all that you claim. I am perfectly satisfied and very proud of my set, and I assure you it has no stronger booster here in Chicago than myself.

I wish to thank the Experimenters Information Service for their willingness to satisfy and do the right thing by their customers; after all, satisfaction is worth more than money.

I would ask you to keep my name on your mailing list and if in the future any new improvement in your Receivers be developed, which you think I would be interested in, I would appreciate hearing from you.

I thank you for your personal interest and service shown me in the past, and wish you all success for the future.

Sincerely yours,

Signed DANIEL J. FRAWLEY.

ALVIN D. BEYER
Insurance
Norristown Trust Bldg.
Norristown, Pa.

January 25, 1924.

Experimenters Information Service,
476 Broadway,
New York City.

Gentlemen:

Dr. Frank C. Parker, Surgeon of the Wills Eye Hospital, has assembled two sets, one for himself and one for the Writer; now Mr. Neeley, of the *Philadelphia Ledger* staff, wants Dr. Parker to write for him an article and give him a photograph of the set complete. Last night up to nine o'clock, when the Writer left to go home, he had in over twenty stations on the loud speaker and I was wondering if you would like to see Dr. Parker's write-up before he submits it for publication. I can assure you that both the Writer and Dr. Parker are more than delighted with the results that we have had so far with our sets.

Mr. Roberts, of the Newark Coil Company, was taken to Dr. Parker's home to hear his set; he arrived there at seven, as he could only stay a few minutes; it was after ten when he left. At the time of Mr. Robert's arrival, Dr. Parker did not know of his position with the Newark Coil Company, and so he tuned in various stations. Finally he tuned in Schenectady and disconnected the ground from the set, with the result that the music continued to come in the loud speaker. Mr. Roberts looked all around the table where the set was kept and then asked Dr. Parker to hold the wire so as to convince himself thoroughly of the music coming in with the set disconnected after once it had been started. He told Dr. Parker that he had never seen a set equal to it and he had seen eight or nine different sets. It was then that Dr. Parker found out he was an engineer. We thought you would be interested to know this, showing that anyone buying your equipment and installing it according to your blue prints will get good results.

Yours very truly,

Signed ALVIN D. BEYER.

September 26, 1923.

Experimenters Information Service,
476 Broadway,
New York City.

Gentlemen:

Parts for Model "C" and Antenna Adapter assembled and wire per your blue prints. I received stations from coast to coast and five (5) Canadian broadcasters with plenty of volume through the static in two evenings' test on a fifty-foot cage aerial. This far exceeds my expectations.

Yours very truly,

C. E. LONG,
214 W. S. Water St.,
Chicago, Illinois.

W. H. HILT
 Grain, Flour and Feed
 Bern, Kansas

September 19, 1923.

Experimenters Information Service,
 476 Broadway,
 New York City.

Gentlemen:

I have been using your Model "C" Super-Heterodyne for some time. It has the greatest range and volume of any Receiver I ever saw or used. We never use but one stage of audio to reproduce WJY—WEAF or Los Angeles, on the Magnavox, static has been very bad here for some time, but have logged everything in the country worth while.

Yours truly,

W. H. HILT.

CHAS. B. DOLLOFF
 7 Commercial St.
 Boothbay Harbor, Maine

July 23/23.

Experimenters Information Service,
 476 Broadway,
 New York City.

Gentlemen:

I have recently completed the Model "C" Super-Heterodyne radio set from the parts and drawings furnished by you. This set is the most perfect working radio set that I or many other radio engineers have ever used.

Yours very truly,

Signed CHAS. B. DOLLOFF.

HORATIO P. BELT
 Av. Rio Branco, 102- 2-º andar
 Rio de Janeiro

Results Obtained on S. S. Western World with Model "L"

- Feb. 20 Chicago, Newark, Louisville, Pittsburgh, New York, Kansas City.
- Feb. 21 1700 S. E. New York, WOC Davenport, Iowa.
- Feb. 22 2450 miles S. E. New York, WJZ Newark, Waldorf Astoria and McAlpin.
- Feb. 23 2700 miles S. E. New York, WGY Gen. Electric Schenectady, WOR Newark, WDAA Nashville, Tenn.
- Feb. 23 3000 miles S. E. New York, Greb-Gardner prize fight—*plainly heard the blows and the roars of the crowd and referee's statements.*
- Feb. 24 3350 land miles S. E. New York, 11 p.m. ship's time, 8 p.m. Eastern time, near equator, bad static WJZ—KDKA—KYW.
- Feb. 25 Sunday night, 3825 land miles from N. Y. church service Pittsburgh, KDKA.
- Feb. 26 4400 land miles from N. Y. attached receiver to ship's main aerial, this apparently did away with some of the static, man's tenor voice, operatic either Valparaiso, Buenos Aires or Rio, more probably the latter.

Static too bad to get anything more en route. I have no doubt but what, used during the dry season, that Rio could get the various Cities in the U. S. with but little difficulty using the Model "L."

J. C. BETZ, M.D.
Boscobel, Wis.

March 28-24.

Experimenters Information Service,
476 Broadway,
New York City.

Dear Sirs:

The Model "C" worked fine the first time I tried it after assembling it. This is the first radio I ever built, and I never saw one constructed, so the plans are surely accurate. Had Oakland, California on a loop.

Very truly yours,

Signed J. C. BETZ.

J. A. BAILEY, JR.
164 Merion Ave.
Narberth, Penna.

July 7, 1923.

Experimenters Information Service,
476 Broadway,
New York City.

Gentlemen:

The Advanced Model "C" Super-Heterodyne Receiver, the parts for which I purchased through you, and assembled by me, has done all that has been claimed for it. I can assure you I am more than pleased with its performance.

Very truly yours,

Signed J. A. BAILEY, JR.

Dr. J. P. Wallace

Dr. B. R. Wallace

WALLACE & WALLACE
Physicians and Surgeons
Albany, Oregon

October 6, 1923.

Experimenters Information Service,
476 Broadway,
New York City.

Gentlemen:

For your information and guidance, will say that my Model "C" Super-Heterodyne, built from your parts and according to Blue Prints, is as near perfect as I believe possible at this time. For Range, Selectivity, Volume, freedom from distortion and other points, it is better by far than anything I have seen or heard. More from loop than from aerial on any other set I know of here.

Just these lines, with a thank you, for your interest and help, and any boost I may give sure will be gladly given.

Yours,

Signed B. R. WALLACE.

KINGSFORD FOUNDRY & MACHINE WORKS
Oswego, New York

October 30, 1923.

Experimenters Information Service,
476 Broadway,
New York City.

Dear Sirs:

I acknowledge receipt of your favor of the 27th inst., and would state that I have changed some of the tubes around in the machine and find that that was the trouble, one of the tubes was defective.

Glad to advise that I got Dallas, Texas, on the loop with enough volume for a loud speaker, but have not been able to get them since, which is probably due to weather conditions.

I trust that you realize I am not criticising the machine when I write you various letters, but all the trouble I have had is due to my lack of knowledge, but the book you kindly sent me is of great assistance, and no doubt as time goes on I will be able to get better results after further practice.

I thank you for your interest in the matter and your willingness to assist me, and remain,

Yours very truly,

Signed THOMAS KINGSFORD.

November 26, 1923.

Mr. J. A. Scherrer,
5043 Conduit Road, N. W.,
Washington, D. C.

Dear Sir:

In reply to your letter of November 23, I am happy to say that I think the Super-Heterodyne as devised by the Experimenters Information Service is a wonderful instrument. I would not sell mine at any price. Would not even trade it for another Super-Heterodyne.

I have tried many makes, and personally had used almost every powerful radio broadcasting receiving set on the market.

Last night my wife tuned in London on the loud speaker. My set is a Model "C" I have stages of radio frequency and a tuner to go ahead of it for antenna and ground. I seem to get everything that anybody can get with eight stages and a loop. I never use head phones.

Sincerely,

Signed WALTER HOWEY,
Editor *Boston American*.

K. C., Mo.,
October 29, 1923.

Experimenters Information Service,
476 Broadway,
New York City.

Gentlemen:

The parts for the "J" Radio Amplifier have been received and installed, and it certainly works fine. I am pulling in stations I did not hear before and stations that I could listen in only on a head set I am playing on a loud speaker.

Yours truly,

Signed B. MOELING,
2801 Olive St.,
Knox City, Mo.

THE F. B. STEARNS COMPANY
Cleveland, Ohio

January 15, 1924.

Experimenters Information Service,
476 Broadway,
New York City.

Gentlemen:

On Saturday night, January 12, I put on a sort of a test on my set, using an RCA loop with a Faradon condenser mounted across it—the results obtained were marvelous.

The total amount of mileage received, adding up all stations, which I will list in this letter was 14,930 miles. All of the stations listed below were received through WTAM; these were all brought in on a loud speaker with an enormous volume.

Naturally the volume on the two California stations and the Calgary station were not quite as loud as the others, but were plenty loud enough to fill my living room, which is 15 x 35 feet, and could be heard very distinctly in any part of it.

The following is a list of the stations received:

KSD	WMC
KDKA	WOAW
KYW	WOC
WBAP	WOR
WCAE	WTAM
WCAP	KFI
WDAF	KPO
WEAF	CFCN
WFAA	WHN
WLAG	WJAZ
WCAL	WDAP

WWJ

It gives me great pleasure to write a letter such as this and there isn't anything that I could say for the Super-Heterodyne set that would be enough for it. I take pleasure in and would be pleased to be quoted as saying that the Super-Heterodyne set is without a doubt the finest radio instrument in the world, barring none.

I have owned and operated practically every type of a circuit and have had sets that I have had much more money invested in than I have in my Heterodyne, but I never had anything that would give me the pleasure and reception that the Heterodyne set does.

The Writer thought possibly this letter might be of interest to you, as the friends that I have up at my house when these stations were brought in marveled at it, said they had never heard anything to equal it.

If at any time the Writer can be of any assistance to you in recommending your article, please do not hesitate to call on him.

Yours very truly,

GEO. C. BOOKER.

P. S.—Stations KPO, KFI and CFCN were not brought in through Cleveland, as Cleveland had signed off when we received them.

E.-I.-S. INC.

476 BROADWAY

NEW YORK CITY, N. Y.

Headquarters for Radio Parts of Quality

GENERAL RADIO PARTS
DUBILIER CONDENSERS
EVEREADY BATTERIES
WESTERN ELECTRIC LOUD SPEAKERS
WILLARD STORAGE BATTERIES
WESTON METERS
PREMIER JACKS
JEWELL METERS
R.C.A. AND CUNNINGHAM RADIOTRONS
GENERAL ELECTRIC TUNGARS
BALDWIN PHONES
FORMICA PANELS
SOLID MAHOGANY CABINETS
SPECIAL ENGRAVING
PALMER PRODUCTS
LABORATORY APPARATUS

*No General Catalog issued. Write for Quotation on any Radio
Apparatus or Material required*

24 Hour Mail Order Service

"New York's Largest Radio Mail Order House"

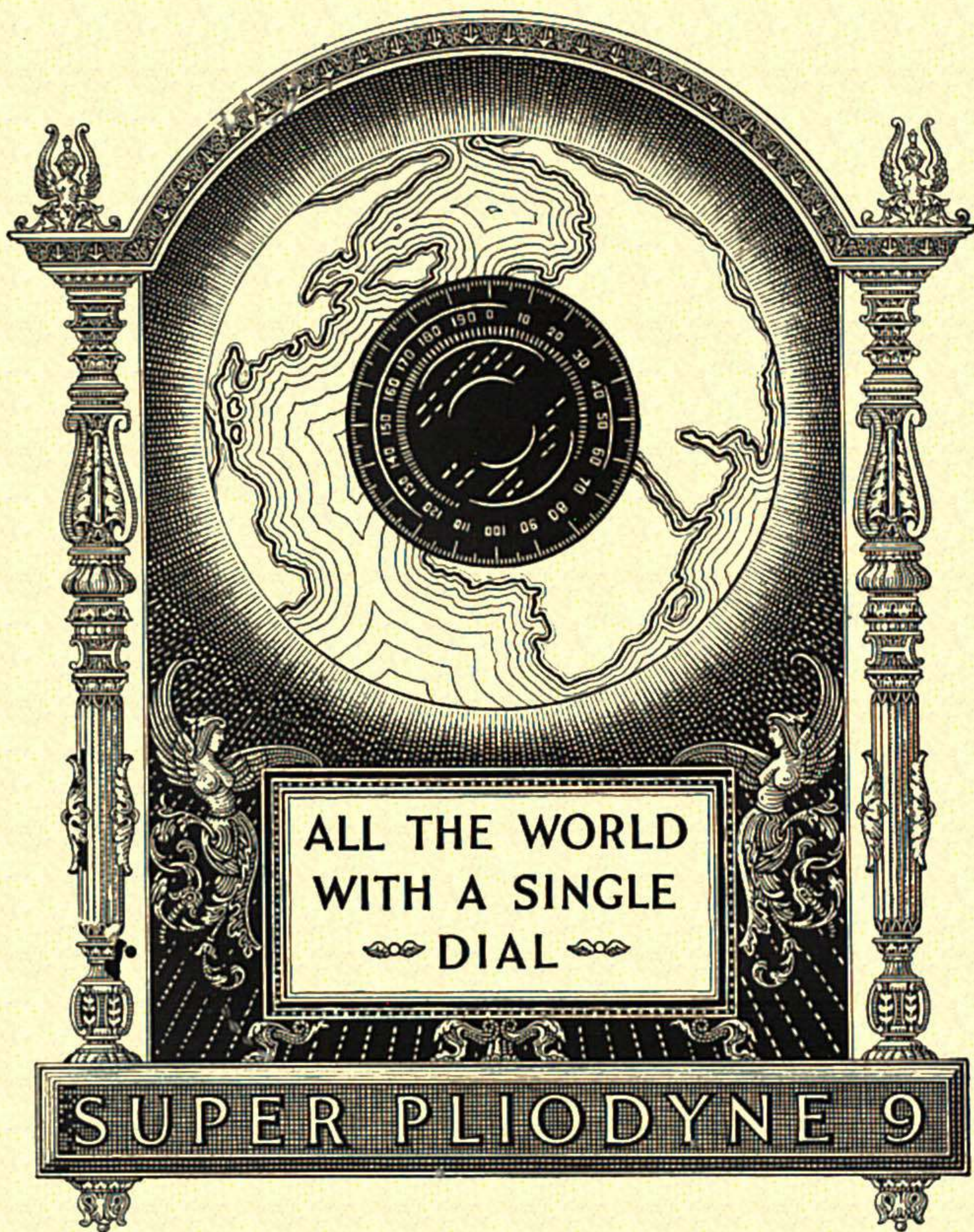

GOLDEN-LEUTZ INC.

MANUFACTURERS OF THE HIGHEST CLASS RADIO APPARATUS IN THE WORLD
476 BROADWAY, NEW YORK CITY

Licensed under Farrand License and Hogan Patent No. 1,014,002

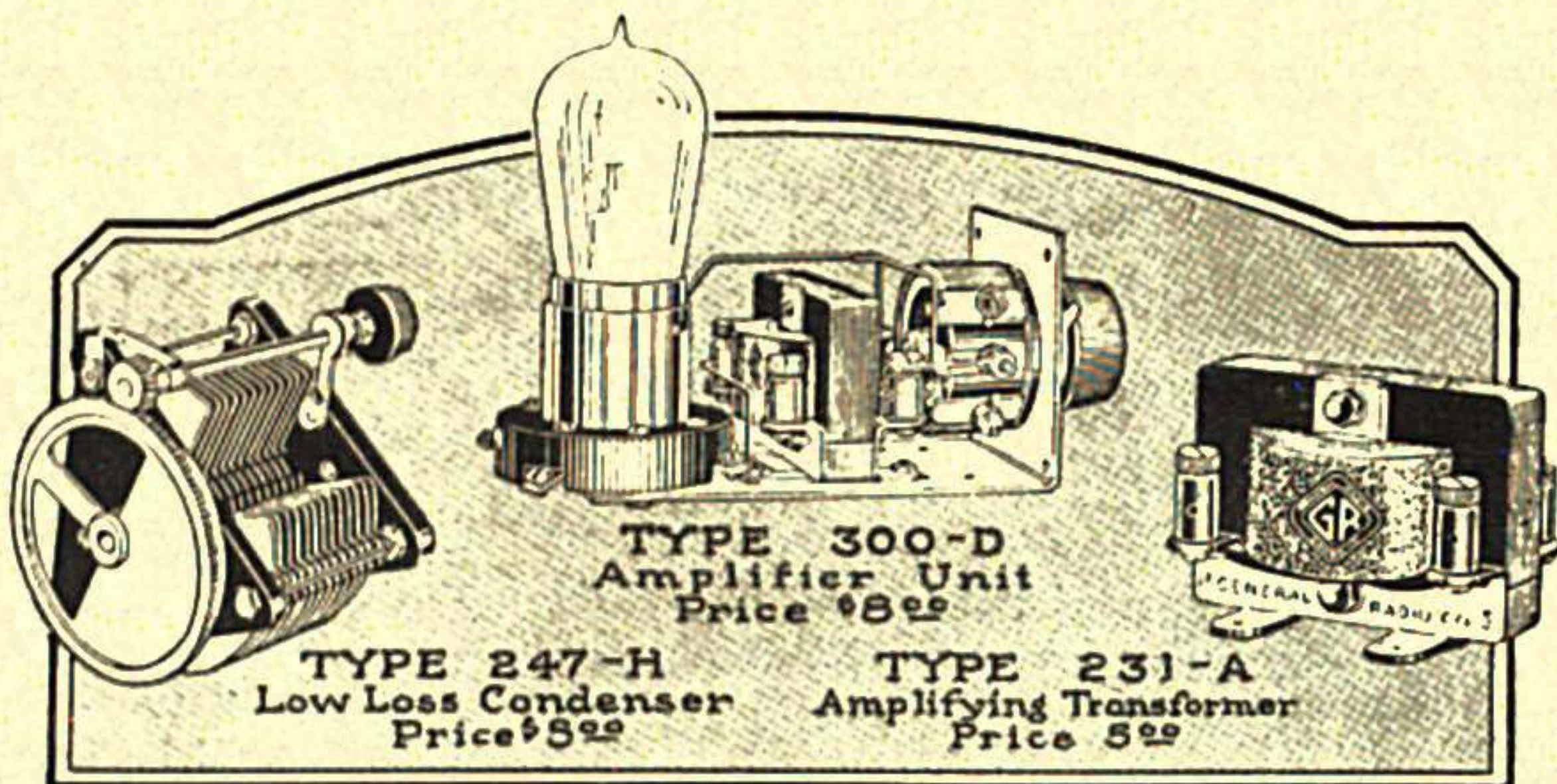

GENERAL RADIO Parts Give *Quality* Reception

Selectivity, distance, clarity, and volume are the qualities which constitute good reception and are what you may expect from your set if you build with GENERAL RADIO parts.

By insisting upon GENERAL RADIO apparatus at the start you avoid the disappointments which so often follow the purchase of inferior parts.

Whatever your circuit—build with GENERAL RADIO parts for Quality Reception.

GENERAL RADIO COMPANY
CAMBRIDGE MASSACHUSETTS

CHARLES R. LEUTZ

CONSULTING ENGINEER

FOREST HILLS : : : NEW YORK



Invites Correspondence
Regarding High-Class Radio Receiving
Installations for

SUMMER CAMPS
WINTER HOMES
APARTMENTS
YACHTS
PRIVATE RAILWAY CARS
AUTOMOBILES
AEROPLANES
SCIENTIFIC EXPEDITIONS
HOTELS
MOTOR BOATS
ESTATES
HUNTING LODGES
ETC.

FOR THOSE THAT WANT AND CAN AFFORD
THE BEST

